

SAM4S

ER-5200M/5240M Electronic Cash Register

Operator's and Programming Manual



All specifications are subject to change without notice.

©2005, CRS, Inc.
M-ER5200/40M Version 2.4

CRS, Inc.

Limited Warranty and Disclaimers of Warranty

This manual has been developed by CRS, Inc. It is intended for the use of its customers and service personnel and should be read in its entirety before attempting to install, use or program the product(s).

Nothing contained in this manual shall be deemed to be, and this manual does not constitute, a warranty of, or representation with respect to, the product or any of the products to which this manual applies. This manual is subject to change without notice and CRS, Inc. has no obligation to provide any updates or corrections to this manual. Further, CRS, Inc. also reserves the right, without prior notice, to make changes in equipment design or components as it deems appropriate. No representation is made that this manual is complete or accurate in all respects and CRS, Inc. shall not be liable for any errors or omissions contained in this manual. In no event shall CRS, Inc. be liable for any incidental or consequential damages relating to or arising out of the use of this manual. This document contains proprietary information that is protected by copyright. All rights are reserved. No part of this document may be photocopied or reproduced without prior written consent of CRS, Inc.

NOTICE

IF ANY WARRANTY IS EXTENDED TO YOU WITH REGARD TO THE PRODUCT(S) TO WHICH THIS MANUAL APPLIES, IT IS A WARRANTY FROM THE ENTITY OR INDIVIDUAL FROM WHOM YOU DIRECTLY PURCHASED THE PRODUCT(S).

SUBJECT TO THE FOREGOING, UNLESS YOU ARE A DIRECT END USER CUSTOMER OF CRS, INC., CRS, INC. DOES NOT EXTEND TO YOU ANY EXPRESS WARRANTY OR ANY IMPLIED WARRANTY AND EXPRESSLY DISCLAIMS ANY IMPLIED WARRANTY OF MERCHANTABILITY, FITNESS FOR USE, OR FITNESS FOR ANY PARTICULAR PURPOSE, OR ANY WARRANTY OF NON-INFRINGEMENT OF INTELLECTUAL PROPERTY RIGHTS IN CONNECTION WITH THE PRODUCT(S) OR ANY SOFTWARE, DRIVERS, OR PROGRAMMING PRODUCT, WHETHER EMBEDDED IN PRODUCT(S) OR PROVIDED AS A SEPARATE PROGRAM, OR USED IN CONJUNCTION WITH THIS/THESE PRODUCT(S). CRS, INC. SPECIFICALLY DOES NOT WARRANT THAT THE OPERATION OF ANY DRIVERS, SOFTWARE, OR PROGRAMMING PRODUCTS LICENSED HEREUNDER, WHETHER EMBEDDED IN PRODUCTS OR PROVIDED AS SEPARATE PROGRAMS, SHALL BE UNINTERRUPTED OR ERROR FREE OR THAT FUNCTIONS CONTAINED IN SUCH DRIVERS, SOFTWARE OR PROGRAMMING PRODUCTS SHALL OPERATE IN COMBINATION(S) WHICH MAY BE SELECTED FOR USE BY YOU OR OTHERWISE MEET YOUR REQUIREMENTS.

CRS, Inc. is not responsible for any damages or loss, either direct, indirect, special, incidental or consequential, which you may experience as a result of your purchase or use of the product(s). Your sole remedy in the event that you encounter any difficulties with the product(s) is against the entity or individual from whom you purchased the product(s).

Revision 2.0 - April 1, 2005

WARNING - U.S.

THIS EQUIPMENT GENERATES, USES AND CAN RADIATE RADIO FREQUENCY ENERGY, AND IF NOT INSTALLED AND USED IN ACCORDANCE WITH THE INSTRUCTIONS MANUAL, MAY CAUSE INTERFERENCE TO RADIO COMMUNICATIONS. IT HAS BEEN TESTED AND FOUND TO COMPLY WITH THE LIMITS FOR A CLASS A COMPUTING DEVICE PURSUANT TO SUBPART J OF PART 15 OF FCC RULES WHICH ARE DESIGNED TO PROVIDE REASONABLE PROTECTION AGAINST SUCH INTERFERENCE WHEN OPERATED IN A COMMERCIAL ENVIRONMENT. OPERATIONS OF THE EQUIPMENT IN A RESIDENTIAL AREA IS LIKELY TO CAUSE INTERFERENCE IN WHICH CASE THE USER, AT HIS OWN EXPENSE, WILL BE REQUIRED TO TAKE WHATEVER MEASURES MAY BE REQUIRED TO CORRECT THE INTERFERENCE.

NOTICE - CANADA

THIS APPARATUS COMPLIES WITH THE CLASS "A" LIMITS FOR RADIO INTERFERENCE AS SPECIFIED IN THE CANADIAN DEPARTMENT OF COMMUNICATIONS RADIO INTERFERENCE REGULATIONS.

CET APPAREIL EST CONFORME AUX NORMES CLASS "A" D'INTERFERENCE RADIO TEL QUE SPECIFIER PAR MINISTRE CANADIEN DES COMMUNICATIONS DANS LES REGLEMENTS D'INTERFERENCE RADIO.

ATTENTION



The product that you have purchased may contain a battery that may be recyclable. At the end of its useful life, under various state and local laws, it may be illegal to dispose of the battery into the municipal waste system.

Check with your local solid waste officials for details concerning recycling options or proper disposal.

Precaution Statements

Follow these safety, servicing and ESD precautions to prevent damage and to protect against potential hazards such as electrical shock.

1-1 Safety Precautions

1. Be sure that all built-in protective devices are replaced. Restore any missing protective shields.
2. When reinstalling the chassis and its assemblies, be sure to restore all protective devices, including nonmetallic control knobs and compartment covers.
3. Make sure there are no cabinet openings through which people - particularly children - might insert fingers and contact dangerous voltages. Such openings include excessively wide cabinet ventilation slots and improperly fitted covers and drawers.
4. Design Alteration Warning:
Never alter or add to the mechanical or electrical design of the SECR. Unauthorized alterations might create a safety hazard. Also, any design changes or additions will void the manufacturer's warranty.
5. Components, parts and wiring that appear to have overheated or that are otherwise damaged should be replaced with parts that meet the original specifications. Always determine the cause of damage or over- heating, and correct any potential hazards.
6. Observe the original lead dress, especially near the following areas: sharp edges, and especially the AC and high voltage supplies. Always inspect for pinched, out-of-place, or frayed wiring. Do not change the spacing between comp-onents and the printed circuit board. Check the AC power cord for damage. Make sure that leads and components do not touch thermally hot parts.
7. Product Safety Notice:
Some electrical and mechanical parts have special safety-related characteristics that might not be obvious from visual inspection. These safety features and the protection they give might be lost if the replacement component differs from the original - even if the replacement is rated for higher voltage, wattage, etc.
Components that are critical for safety are indicated in the circuit diagram by shading, () or (). Use replacement components that have the same ratings, especially for flame resistance and dielectric strength specifications. A replacement part that does not have the same safety characteristics as the original might create shock, fire or other hazards.

CAUTION

Danger of explosion if battery is incorrectly replaced.

Replace only with the same or equivalent type recommended by the manufacturer.

Dispose used batteries according to the manufacturer's instructions.

ATTENTION

Il y a danger d'explosion s'il y a remplacement incorrect de la batterie.

Remplacer uniquement avec une batterie du même type ou d'un type équivalent recommandé par le constructeur.

Mettre au rebut les batteries usagées conformément aux instructions du fabricant.

1-2 Servicing Precautions

WARNING: First read the-Safety Precautions-section of this manual. If some unforeseen circumstance creates a conflict between the servicing and safety precautions, always follow the safety precautions.

WARNING: An electrolytic capacitor installed with the wrong polarity might explode.

1. Servicing precautions are printed on the cabinet. Follow them.
2. Always unplug the units AC power cord from the AC power source before attempting to:
 - (a) Remove or reinstall any component or assembly
 - (b) Disconnect an electrical plug or connector
 - (c) Connect a test component in parallel with an electrolytic capacitor
3. Some components are raised above the printed circuit board for safety. An insulation tube or tape is sometimes used. The internal wiring is sometimes clamped to prevent contact with thermally hot components. Reinstall all such elements to their original position.
4. After servicing, always check that the screws, components and wiring have been correctly reinstalled. Make sure that the portion around the serviced part has not been damaged.
5. Check the insulation between the blades of the AC plug and accessible conductive parts (examples : metal panels and input terminals).
6. Insulation Checking Procedure:

Disconnect the power cord from the AC source and turn the power switch ON. Connect an insulation resistance meter (500V) to the blades of AC plug.

The insulation resistance between each blade of the AC plug and accessible conductive parts (see above) should be greater than 1 megohm.
7. Never defeat any of the B+ voltage interlocks. Do not apply AC power to the unit (or any of its assemblies) unless all solid-state heat sinks are correctly installed.
8. Always connect an instrument's ground lead to the instrument chassis ground before connecting the positive lead ; always remove the instrument's ground lead last.

1-3 Precautions for Electrostatically Sensitive Devices (ESDs)

1. Some semiconductor (solid state) devices are easily damaged by static electricity. Such components are called Electrostatically Sensitive Devices (ESDs); examples include integrated circuits and some field-effect transistors. The following techniques will reduce the occurrence of component damage caused by static electricity.
2. Immediately before handling any semiconductor components or assemblies, drain the electrostatic charge from your body by touching a known earth ground. Alternatively, wear a discharging wrist-strap device. (Be sure to remove it prior to applying power - this is an electric shock precaution.)
3. After removing an ESD-equipped assembly, place it on a conductive surface such as aluminum foil to prevent accumulation of electrostatic charge.
4. Do not use freon-propelled chemicals. These can generate electrical charges that damage ESDs.
5. Use only a grounded-tip soldering iron when soldering or unsoldering ESDs.
6. Use only an anti-static solder removal device. Many solder removal devices are not rated as anti-static; these can accumulate sufficient electrical charge to damage ESDs.
7. Do not remove a replacement ESD from its protective package until you are ready to install it. Most replacement ESDs are packaged with leads that are electrically shorted together by conductive foam, aluminum foil or other conductive materials.
8. Immediately before removing the protective material from the leads of a replacement ESD, touch the protective material to the chassis or circuit assembly into which the device will be installed.
9. Minimize body motions when handling unpackaged replacement ESDs. Motions such as brushing clothes together, or lifting a foot from a carpeted floor can generate enough static electricity to damage an ESD.

Contents

Introduction	9
About the <i>ER-5200M</i> Series	9
Using This Manual	10
Using Flowcharts.....	10
Basic Features and Functions	11
Display	12
Receipt Printer.....	13
Journal Printer	14
Control Lock	15
Keyboards.....	16
Initial Clear.....	18
Operations	21
Function Key Descriptions	21
Clerk Sign-On/Sign-Off	26
Direct Sign-On	26
Coded Sign-On.....	27
Receipt On and Off.....	27
PLU Registrations.....	28
NLU (Keyboard PLU) Entries	28
Numeric PLU Entries	31
Modifier Entries	33
Percentage Key (%) Registrations	34
Void and Correction Operations.....	37
Error Correct	37
Previous Item Void.....	38
Merchandise Return	39
VOID Control Lock Position (Transaction Void).....	40
Cancel.....	41
Subtotal Operations	42
Subtotal.....	42
Add Check (Tray Subtotal)	42
Eat-In/Take-Out/Drive Thru Operations	43
Tax Shift Operations.....	44
Tendering Operations	46
Cash.....	46
Check.....	46
Charge	47
Split Tender	48
Post Tendering.....	48
Receipt on Request	49
Training Mode	49
Clerk Interrupt	49

Non-Add Number	50
No Sale.....	50
Received on Account.....	51
Paid Out	51
Table Service Restaurant Operations.....	52
Overview	52
Posting Guest Checks Manually with the Previous Balance Key	54
Soft Check	55
Hard Check.....	58
Fast Food Drive Thru	61
Promo Function	62
Waste Function.....	62
Charge Posting Operations	63
Currency Conversion	66
Food Stamp Operations	67
Scale Operations	68
Direct Scale Entry.....	68
Manual Weight Entry	68
Scale With Automatic Tare Entry.....	69
Scale With Manual Tare Entry	69
Integrated Payment Operations.....	69

Management Functions 71

Introduction.....	71
Cash Declaration.....	72
System Reports	74
Running a Report – General Instructions	74
Report Table.....	75

S-Mode Programming 77

Overview.....	77
Clearing Memory	78
Memory All Clear.....	78
Clear All Totals and Counters	78
Clear Grand Total	79
Clear PLU File.....	79
Self Tests	79
EPROM Information.....	80
Memory Allocation.....	81
Memory Expansion	81
Memory Calculation Worksheet.....	81
Memory Allocation Program.....	82
Memory Allocation Program Scan	83
Function Key Assignment Programming.....	84
Function Key Codes	85
ER-5240M Keyboard Expansion.....	86
RS-232 Communication Option Programs	87
RS-232 Option Chart.....	87
Updating Firmware Program	89
Update Files.....	89
PC Connection Cable	89
Update Boot Area	91
Update Program Area	90

P-Mode Programming

93

Default Program	93
Tax Programming	94
Straight Percentage Tax Rate Programming	95
Tax Table Programming.....	96
PLU Programming.....	98
Program 100 - PLU Status Programming.....	99
Program 110 - PLU Auto Tare Programming	102
Program 150 - PLU Group Assignment.....	103
Program 200 - PLU Price/HALO Programming	104
Program 250 - PLU Stock Amount Programming	105
Program 300 - PLU Descriptor Programming.....	106
Program 350 - PLU Link Programming.....	109
Program 400 - PLU Delete Programming	110
Program 450 - PLU Mix and Match Programming	111
System Option Programming.....	112
System Option Table.....	113
System Options - Reference Information	116
Print Option Programming	118
Print Option Table.....	119
Function Key Programming	124
Program 70 - Function Key Options	124
Program 80 - Function Key Descriptor	125
Program 90 - Function Key HALO.....	126
Instructions for Currency Conversion Rate - Program 90.....	127
ADD CHECK - Function Key Options	128
CANCEL - Function Key Options	128
CASH - Function Key Options	129
CHARGE 1-8 - Function Key Options	130
CHECK - Function Key Options.....	131
CHECK CASHING - Function Key Options.....	132
CHECK ENDORSEMENT - Function Key Options	132
CHECK # - Function Key Options.....	133
DRIVE THRU / EAT IN / TAKE OUT - Function Key Options	134
ERROR CORRECT - Function Key Options.....	135
F/S Subtotal - Function Key Options	135
F/S TEND - Function Key Options.....	136
GUEST - Function Key Options	136
#/NS - Function Key Options	137
MDSE RETURN - Function Key Options	137
MODIFIER 1-5 - Function Key Options	138
PBAL - Function Key Options.....	138
PROMO - Function Key Options.....	139
PAID OUT 1-3 - Function Key Options	139
PRINT CHECK - Function Key Options	140
RECD ON ACCT 1-3 - Function Key Options.....	140
SCALE - Function Key Options	141
SERVICE - Function Key Options	142
SUBTOTAL - Function Key Options	142
TARE - Function Key Options.....	143
TAX EXEMPT - Function Key Options	144
TIP - Function Key Options	145
VALIDATE - Function Key Options.....	145
VOID - Function Key Options	146

WASTE - Function Key Options	146
%1-%5 Function Key Options.....	147
Mix and Match Discount Programming	148
Program 600 – Trip Level Programming.....	149
Program 601 – Price Programming	149
Program 610 – Mix & Match Descriptor Programming.....	150
Clerk Programming.....	151
Program 800 - Secret Code Programming.....	151
Program 801 - Drawer Assignment	152
Program 810 - Clerk Descriptor Programming	152
Group Programming	153
Miscellaneous Programming	155
Program 1500 - Macro Key Sequence Programming.....	155
Program 700 – Logo/Endorsement Message Programming	156
Program 701 - Financial Report Descriptor Programming.....	157
Program 710 - Clerk Report Descriptor Programming.....	159
Program 711 - Macro Name Programming	161
Program 720 – DataTran Message Program.....	162
Program 1000 - NLU Code Number Programming	163
Program 1100 - Cash-In-Drawer Limit Programming	164
Program 1200 - Check Change Limit Programming	165
Program 1300 - Date and Time Programming	166
Program 1400 - Scale Tare Weight Programming	167
Program 1600 - Machine Number Programming	168
Program Scans	169

Sample Reports 171

Financial	171
Time.....	175
PLU.....	176
Clerk	177
Individual Clerk.....	178
Groups	179
Stock.....	180
Open Check	181
Balancing Formulas	182

Integrated Payment Appendix 183

One Day Example of Credit Authorization	183
Open Batch.....	183
Sample Transaction	184
Manual Card Entry	185
Merchandise Return.....	185
Void Transaction	186
Local Total Report.....	186
Tip (Gratuity) Entry.....	186
Close Batch.....	187
Reset Mode Procedures	188
DataTran Function Table.....	188
Initialize EFT.....	188
Clear Curr Batch.....	188
Chg Batch Number	189
Issue Local Total	189

Issue Transaction.....	190
Issue Batch Status.....	190
Dial In Load/Dial Out Load	191
Required ECR Programs.....	191
Local Transaction Report Key	191

Index	195
--------------	------------

Introduction

About the *ER-5200M* Series

The *ER-5200M* Series is offered in two different versions:

- The *ER-5200M* features a flat 160-position keyboard with 117 NLU keys. Because it offers protection from spills, this keyboard works best in restaurants, food service shops, or convenience stores where food is served.
- The *ER-5240M* features a 90-position keyboard with traditional raised keys. In the standard configuraton, the keyboard provides 15 NLU keys – it can be expanded to 40 NLU keys. The *ER-5240M* works best in retail stores, or shops where it is not necessary to place a large number of preset item keys on the keyboard.

This manual includes instructions for both models. The keyboard is the only significant difference between the two models. All other features are the same, unless otherwise noted.

Using This Manual

With this manual we hope to provide you with a means to use your *SAM4s* cash register to its fullest potential.

This manual is divided into six sections:

- "Introduction" on page 9, explains basic features and functions.
- "Operations" on page 21, guides you through the basic operation sequences.
- "Management Functions" on page 71, explains manager controlled functions, along with reports and balancing information.
- "S-Mode Programming" on page 77 provides instructions for secure programming – usually done by the installing dealer prior to installation.
- "P-Mode Programming" on page 93 provides complete programming instructions, including PLU, function key programs, and system options. This section is recommended for use by storeowners and managers. Call your *SAM4s* dealer if you find you need programming assistance.
- "Sample Reports" on page 171 provides a sample of each register report.

The *SAM4s ER-5200M/5240M* allows many different configurations. This manual was written with this in mind. Although we have tried to touch on all available options, your machine may differ.

If you have questions concerning the configuration of your *ER-5200M/5240M*, contact your authorized *SAM4s* dealer.

Using Flowcharts

Flowcharts are used to supplement step-by-step instructions throughout this manual. For example, the following flowchart describes how to register \$1.00 into the **PLU1** key:



This flowchart means:

1. Press numeric key **1**.
2. Press numeric key **0**.
3. Press numeric key **0**.
4. Press **PLU #1**.

Follow the flowchart from left to right, pressing the keys in the order they are shown. Numeric keypad entries are shown as square keys. PLU and function keys are shown as rectangular keys.

Basic Features and Functions

The *SAM4s ER-5200M/5240M* electronic cash register is designed to fit into many different retail and restaurant environments.

Standard Features Include:

- Separate receipt and journal thermal printers, featuring easy drop-and-print paper loading and an optional receipt auto cutter.
- Cash drawer with 5 bill and 5 coin compartments.
- A two-line 16-character backlit LCD display and a 10-character and rear pop up display.
- 7-position control lock.
- 24-hour real-time clock with automatic day and date change.
- Four tax rates with value added tax (VAT) capability. Each tax rate is programmable for tax table look-ups and/or straight percentage tax programming. Tax rate 4 may be programmed to accommodate Canadian goods and services tax (GST).
- Memory allocation system and optional memory expansion supports the following system features:
 - Operation for up to 99 clerks or cashiers with separate report totals. Your *SAM4s* dealer can provide an optional second drawer.
 - 117 Price Look Ups (PLUs), up to a maximum of 10,000 PLUs are available for open or preset item registration. (The exact number of PLUs is determined by memory allocation. Memory expansion is required to support PLU files larger than the default quantity of 1000.) For direct registrations, up to 117 PLUs are on the *ER-5200M* keyboard, up to 40 PLUs are on the *ER-5240M* keyboard.
 - 20 group totals, up to a maximum of 99 group totals are available to accumulate totals of individual PLUs that are assigned to each group. Each PLU can be assigned to up to three different groups.
 - Hard or soft check tracking for up to 500 guest checks, with soft checks containing up to 50 lines of items.
 - 20, up to a maximum of 99 Mix and Match PLU discount tables.
- Up to 5 PLU modifier keys (i.e. small, medium, and large).
- A programmable keyboard allowing customized placement of functions, as they are needed. (See "Function Key Descriptions" on page 21 for a list of available functions).
- Function keys for posting charges and payments to accounts or guest checks. You can choose manual previous balance posting or automatic balance tracking..
- Food stamp sorting and tendering for stores that accept food stamp payments.
- Check, Cash, and up to eight Charge keys.
- Management **X** and **Z** reports.
- Two RS-232C communication ports for connection to an optional POS peripheral. The *ER-5200M* series can connect to a scale, kitchen printer, scanner, coin dispenser, pole display, modem, DataTran integrated payment appliance, or a PC for polling and/or programming.

Display

The *ER-5200M/5240M* comes with a two-line 16-character backlit LCD display.

```
CASH          100.00
CHANGE        0.00
```

As items are registers, the item description will display on the first line; price and quantity information will display on the second line. Additional information and error messages will display as appropriate, and may be accompanied by an error tone.

Messages and Error Conditions

SEQUENCE ERROR	REQ. SUBTOTAL
PLU NO DATA ERR	PROMO ERROR
CLERK ERROR	CHECK OPEN ERR
AMOUNT CNT ERR	REQ. PASSWORD
LANTRAN ERR	NO VOID PLU
COMM ERROR	REQ. PORT SETUP
TIME ERROR	REQ. PRESET VALUE
OVER LIMIT ERR	REQ. OPEN VALUE
INACTIVE ERROR	REQ. AMOUNT
X MODE ONLY	REQ. PAYMENT
NON ADD ERROR	INVALID FUNC.
ADD CHECK ERR	REQ. TABLE #
CONDIMENT ERROR	REQ. PBAL
REQ. EATIN FUNC	REQ. CHECK #
STOCK ERROR	ONLY ONE TABLE
DRAWER ERROR	REQ. VALID
REQ. GUEST #	RECPT PAPER END
SCALE ERROR	RECPT NEAR END
CLERK NO MATCH	COVER OPEN ERR
COMPULSORY TARE	CUTTER JAM ERR
REQ. DECLARATION	J PAPER END
OFF LINE ERROR	J NEAR END
REQ. ENDORSEMENT	POWER FAIL ERR
CONSOL OVER	CHARGE POST ERR

Receipt Printer

- SMT-210
- Print speed: 13.3 lines per second
- Print columns: 32
- Paper size: 2 ¼" (58mm) width
- Auto cutter (optional)

Sample Receipt

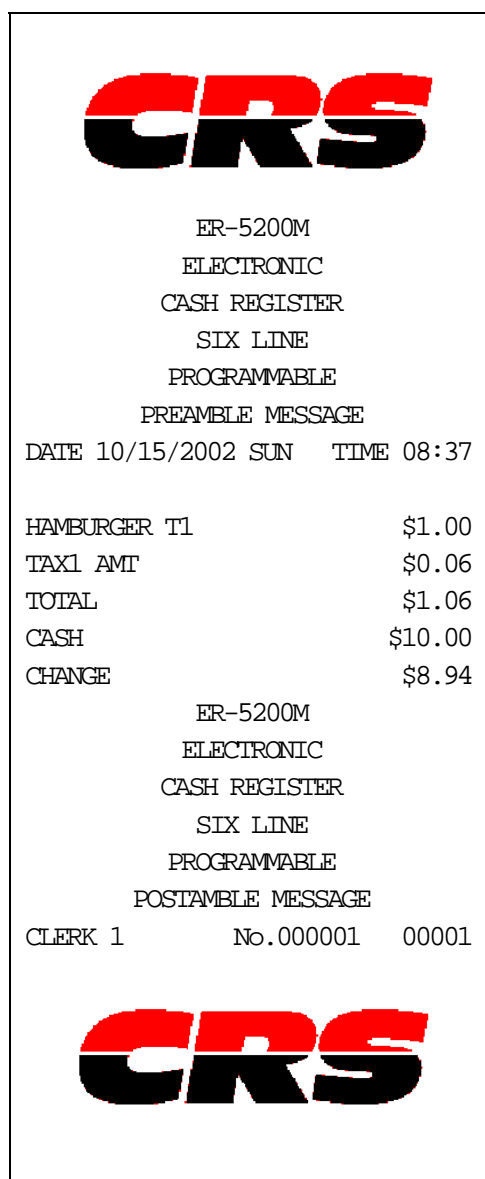

User defined graphic logo

6 line programmable preamble message

Date/Day

6 line programmable postamble

Clerk/Consecutive #/
Register #

User defined graphic logo

Journal Printer

- SMT-210
- Print speed: 13.3 lines per second
- Print columns: 32 (condensed format)
- Paper size: 2 1/4" (58mm) width.

Sample Journal

```
DATE 10/15/2002 SUN    TIME 08:37
HAMBURGER T1          $1.50
COUPON T1             $-0.50
TAX1 AMT              $0.06
TOTAL                $1.06
CASH                  $10.00
CHANGE                $8.94
CLERK 1              No.000001 00001
DATE 10/15/2002 SUN    TIME 08:38
HAMBURGER T1          $1.00
TAX1 AMT              $0.06
TOTAL                $1.06
CASH                  $10.00
CHANGE                $8.94
CLERK 1              No.000002 00001
```

Journal print can be condensed to save paper, or can be printed in normal size.

Negative items can be printed in reverse print to facilitate journal review (see "System Option Programming" on page 112.)

Control Lock

The control lock has 7 positions, accessed with 5 keys. Each ECR is shipped with two full sets of keys.

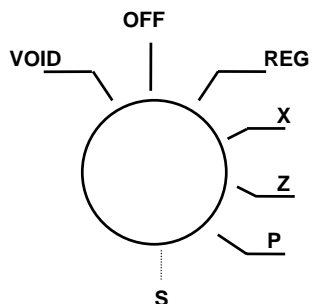

- VOID** Use to void (correct) items outside of a sale.
- OFF** The register is inoperable.
- REG** Use for normal registrations.
- X** Use to read register reports.
- Z** Use to read register reports and reset totals to zero.
- P** Use to program the register.
- S** The S position is a hidden position reserved for dealer access.

Before performing any operations in Register Mode a clerk must be signed on. See “Clerk Sign-On/Sign-Off” for a description of clerk operations.

Control Keys

The *ER-5200M/5240M* includes two sets of keys that may be used to access the following control lock positions.

Key	Positions Accessible
REG	OFF, REG
VOID	VOID, OFF, REG, X
Z	VOID, OFF, REG, X, Z
P	VOID, OFF, REG, X, Z, P
C	ALL POSITIONS

Note: Keys may be removed from the control lock in the OFF or REG positions.

Keyboards

ER-5200M Keyboard

The *ER-5200M* keyboard includes 160 key positions with the default legends and key assignments as shown below. The keyboard legend sheet can be replaced by lifting the protective plastic cover.

Programmable key locations are shown with a bold border.

RECT FEED	DETL FEED	RCPT ON/OFF										TAX 1 SHIFT	F/S SHIFT	PAID OUT	CLERK
												TAX 2 SHIFT	CHECK #	RECD ACCT	F/S SUB
												% 1	SERVICE	VOID	F/S TEND
												% 2	ERROR CORR	RETURN	EAT IN
												% 3	#/NS	CANCEL	TAKE OUT
												CLEAR	PLU	X/TIME	CHARGE 2
												7	8	9	CHARGE 1
												4	5	6	CHECK
												1	2	3	SBTL
												0	00	.	CASH

ER-5240M Keyboard – Default 15 NLU Configuration

The ER-5240M keyboard is shown below with the default legends and key assignments. This configuration has 15 keyboard NLU locations and can be expanded to 40 NLU locations.

Programmable key locations are shown with a bold border.

RECT FEED	DETL FEED	RCPT ON/OFF	#/NS	TAX 1	TAX 2	F/S SHIFT	RECD ACCT	PAID OUT	MACRO 1	MACRO 2	MACRO 3	MACRO 4	MACRO 5	CLERK
ERROR CORR	P L U	CLEAR		X/TIME			1		6		11		F/S SUB	CHARGE 1
VOID		7	8	9			2		7		12		F/S TEND	CHARGE 2
CANCEL	RETURN	4	5	6			3		8		13		CHECK	
% 1	% 3	1	2	3			4		9		14		SBTL	
% 2	% 4	0	00	.			5		10		15		CASH	

ER-5240M Keyboard – Expanded 40 NLU Configuration

RECT FEED	DETL FEED	RCPT ON/OFF	#/NS	TAX 1	TAX 2	F/S SHIFT	RECD ACCT	PAID OUT	MACRO 1	MACRO 2	MACRO 3	MACRO 4	MACRO 5	CLERK
ERROR CORR	P L U	CLEAR		X/TIME	1	6	11	16	21	26	31	36	F/S SUB	CHARGE 1
VOID		7	8	9	2	7	12	17	22	27	32	37	F/S TEND	CHARGE 2
CANCEL	RETURN	4	5	6	3	8	13	18	23	28	33	38	CHECK	
% 1	% 3	1	2	3	4	9	14	19	24	29	34	39	SBTL	
% 2	% 4	0	00	.	5	10	15	20	25	30	35	40	CASH	

Initial Clear

CAUTION: Do not share this information with unauthorized users. Distribute the P Mode key only to those you may want to perform this function.

The initial clear function allows you to exit any register activity and return to a beginning or cleared state. Any transaction that is in progress will be exited and totals for that transaction will not be updated.

Here are some reasons you may want to perform an initial clear:

- The register is in an unknown state, and you wish to exit the current program or transaction without following normal procedures.
- You have performed a function that includes a compulsory activity and you wish to bypass the compulsion.
- An initial clear may be necessary as part of servicing, or troubleshooting.

Perform this procedure only as necessary. Contact your *SAM4S* dealer first if you have questions about operating or programming your *SAM4s ER-5200M/5240M*.

To Perform an Initial Clear:

1. Turn the power switch located on the right side of the register to the OFF position.
2. Turn the control lock to the **P** position.
3. Press and hold the key position where the **SBTL** key is located on the default keyboard layout.
4. While continuing to hold the **SBTL** key, turn the power switch to the ON position.
5. The message "INITIAL CLEAR OK!" prints when the initial clear is complete.

Operations

Function Key Descriptions

Keys are listed in alphabetical order. Many of the keys described below are not included on the default keyboard. See “Function Key Assignment Programming ” on page 84 to add or change programmable keys.

Keyboard Legend	Description
#/NS	Use as a non-add key to print a numeric entry (up to 9-digits) on the receipt and journal. This entry will not add to any sales totals. The #/NS key is also used to open the cash drawer without making a sale.
X/TIME	Use to multiply a quantity of items or calculate split pricing on PLU entries.
00, 0-9, Decimal	Use to make numeric entries in REG, X, Z, VOID, or P positions. The decimal key is used for decimal or scale multiplication, when setting or entering fractional percentage discounts, or when programming fractional tax rates. Do not use the decimal key when making amount entries into PLUs.
ADD CHECK	Use to combine individual trays (such as in a cafeteria situation). Each tray subtotal can advance the consecutive number, depending on programming.
CANCEL	Cancels a transaction without updating PLU, or function key totals. The Cancel function may only be used prior to tendering. Once tendering begins, the Cancel function may no longer be used. The CANCEL key corrects the appropriate totals and counters and the Financial report records total of transactions canceled.
CASH	Use to finalize cash sales. Calculates the sale total including tax and opens the cash drawer. Change computation is allowed by entering an amount before pressing the CASH key. The cash drawer will open only if the amount tendered is equal to or greater than the total amount of the sale. Post tendering is also available should a second change calculation be necessary. Re-enter the tendered amount and press the CASH key to show the new change computation. Press the CASH key a second time to issue a buffered receipt (up to 200 lines) when the receipt on/off function is OFF.

Keyboard Legend	Description
CHECK	Use to finalize check sales. Calculates the sale total including tax, finalizes the sale, and opens the cash drawer. Change computation is allowed by entering an amount before pressing the CHECK key. The cash drawer will open only if the amount tendered is equal to or greater than the total amount of the sale. Change issued will be subtracted from the cash-in-drawer total.
CHECK CASHING	Use to exchange a check for cash. Cash-in-drawer and check-in-drawer totals are adjusted.
CHECK ENDORSEMENT	Use to print a check endorsement message on an optional slip printer after a check has been tendered. See “Programming the Receipt/Check Endorsement Message” on page 156 to program an endorsement message.
CHARGE (1-8)	Use to finalize charge sales. Calculates the sale total including tax, finalizes the sale, and opens the cash drawer. Change computation is allowed by entering an amount before pressing the CHARGE key. The cash drawer will open only if the amount tendered is equal to or greater than the total amount of the sale. Change issued will be subtracted from the cash-in-drawer total.
CHECK #	<p>The CHECK # key is used to begin a new, or access an existing balance (hard check) or itemized bill (soft check).</p> <p>Check track numbers that are entered manually may be set at a fixed length of one to nine digits. Check track numbers assigned automatically will begin with #1.</p> <p>Existing checks are accessed by entering the check track number and pressing the CHECK # key.</p>
CLEAR	Use to clear entries made into the 10 key numeric pad or X/TIME key before they are printed. Also used to clear error conditions.
CLERK	<p>The register will not operate in register mode unless a clerk has been signed on. Direct or secret code sign on procedures accomplishes clerk sign-on.</p> <p>All entries made on the register will report to one of the 10 clerk totals. When a clerk is signed on, all entries following will add to that clerk’s total until another clerk is signed on.</p> <p>To sign a clerk off, enter 0 (zero) and then press the CLERK key. The “CLOSEd” message displays. The register cannot be operated until another clerk is signed on. The current clerk must first be signed off before another clerk may be signed on.</p>
CONV (1-4)	The currency conversion function, allowed after subtotal, converts and displays the new subtotal at a preprogrammed exchange rate. Tendering is allowed after using the currency conversion function. Change is calculated and issued in home currency. The amount of foreign currency tendered is stored in a separate total on the Financial report, but not added to the drawer total.
DETAIL FEED	Advances the detail paper one line, or continuously until the key is released.

Keyboard Legend	Description
EAT-IN TAKE OUT DRIVE THRU	<p>Eat-In, Take Out and Drive Thru are subtotal functions. In areas that have different tax rules for eat-in and take out sales, the EAT-IN, TAKE OUT and DRIVE THRU keys can be programmed to automatically charge or exempt taxes.</p> <p>Sales may not be split between Eat-In, Take Out and Drive Thru.</p> <p>The EAT-IN, TAKE OUT and DRIVE THRU keys maintain separate totals on the Financial report.</p>
ERROR CORR	Use to correct the last entry. The ERROR CORR key corrects the appropriate totals and counters.
F/S SHIFT	When pressed before a PLU entry, the F/S SHIFT key reverses the preprogrammed food stamp status of the PLU. For example, an item not food stamp eligible can be made food stamp eligible.
F/S SUB	Displays the amount of the sale that is food stamp eligible.
F/S TEND	Use to tender food stamps for eligible sales.
FINALIZE	Pressing before closing a check will close the account and the account number will no longer be reported on the open check report. The system option for charge posting must be set to “ Y ” in order to use this function.
GUEST #	Use to enter the count of guests served.
MACRO (1-10)	Macro keys may be programmed to record, and then later perform, up to 50 keystrokes. For example, a macro key could be set to tender (preset tender) a common currency, such as \$5 into the cash key.
MDSE RETURN	Used to return or refund merchandise. Returning an item will also return any tax that may have been applied.
MODIFIER (1-5)	The MODIFIER key alters the next PLU registered, either by changing the code number of the PLU so that a different item is registered, or by adding the modifier descriptor (and not changing the code of the subsequent PLU.)
P/BAL	Use to enter the amount of an outstanding balance.
PAID OUT (1-3)	Use to record money taken from the register to pay invoices, etc. The paid out amount subtracts from the cash-in-drawer total. Paid outs are allowed outside of a sale only.
% 1 - % 5	Up to five % keys may be placed on the keyboard. Each % key is set with a specific function, such as item discount or surcharge, or sale discount or surcharge. The percent rate may be entered or preprogrammed, or the percent keys can be programmed with a negative open or preset price, thus acting as coupon keys.
PLU	The PLU key is used to register price lookups by number entry. PLUs can be programmed open or preset, and positive or negative.
PAYMENT	Press to make a payment, partial payment, or pre-payment while posting to a check (account). If the payment amount exceeds the check balance, a credit balance will be maintained. The system option for charge posting must be set to “ Y ” in order to use this function.
PAY TENDER	Functions like the Payment key, except if the payment amount exceeds the check balance, the overpayment will be issued as change and the account balance will be zeroed. The system option for charge posting must be set to “ Y ” in order to use this function.

Keyboard Legend	Description
PRINT CHECK	Use to print a guest check. The check can be printed on an optional (RS-232C) printer, or can be printed on the receipt printer. The PRINT CHECK key can be set to automatically service the check.
PROMO	The PROMO key allows you to account for promotional items, as in "buy two, get one free". Pressing this key will remove an item's cost from the sale, but will include the sale of the item in the item's sales counter.
RECT FEED	Advances the receipt paper one line, or continuously until the key is released.
RCPT ON/OFF	When 'OFF' no receipt will print during a sale. (If the receipt is off, a buffered receipt is available by pressing the CASH key a second time.)
RECD ACCT (1-3)	The RA (received on account) key is used to record media loaned to the cash drawer, or payments received outside of a sale. The cash drawer will open. The amount received adds to the cash-in-drawer total.
SCALE	Use to make weight entries. When a scale is attached, press the scale key to show the weight in the display, then press (or enter) a PLU to multiply the weight times the price. When a scale is not attached, you can enter the weight (using the decimal key for fractions). PLUs may be programmed to require an entry through the scale key.
SERVICE	Use to temporarily finalize Previous Balance or Check/Table tracking transactions.
SBTL	Displays subtotal of sale including tax. Must be pressed prior to a sale discount or sale surcharge.
TABLE #	Tracks the current balance for a guest check or table.
TARE	Tares are container weights. If you are using the scale function, you can preset up to 5 different tare weights. The tare can be subtracted automatically when a specific PLU is registered, or manually inputting the tare number and pressing the TARE key can subtract the tare. Tare #5 can be programmed for entering tare weights manually.
TAX EXEMPT	Press the TAX EXEMPT key to exempt tax 1, tax 2, tax 3, and/or tax 4 from the entire sale.
TAX (1-4) SHIFT	When pressed before a PLU entry, the tax shift keys reverse the tax status of the PLU, i.e., a PLU with non-tax status would become taxable or a PLU with tax status would become non-taxable.
TIP	The TIP key allows a gratuity to be added to a guest check before payment. The tip amount is deducted from the Cash-in-Drawer amount for the Clerk/Cashier closing the guest check. The TIP key may be programmed as either a percentage or amount. If programmed as a percentage, tax programming defines whether the percentage is calculated on the net amount, or the amount after taxes.
VOID	Use to correct an item entered earlier within a sale. The VOID key corrects the appropriate totals and counters. To correct the last item, use the ERROR CORR key. For void operations outside of a sale (Transaction Void), use the VOID position on the control lock. The Financial report records totals for each type of void separately.
VALIDATION	If you are using an optional slip printer, you can press the VALIDATION key to print a three-line validation on a separate form or piece of paper. Any item registration, discount or payment may be validated

Keyboard Legend

Description

WASTE

The **WASTE** key allows control of inventory by accounting for items that must be removed from stock due to spoilage, breakage or mistakes. Press the **WASTE** key before entering wasted items, and then press the **WASTE** key again to finalize. The **WASTE** key may be under manager control, requiring the control lock to be in the **X** position. The **WASTE** key is not allowed within a sale.

Clerk Sign-On/Sign-Off

See "System Option Programming", to review your clerk options: (System option #2 allows you to select direct or code entry sign on, option #3 allows you to select stay-down or pop-up operation, and option #26 allows you select clerk interrupt operations.)

Depending on how your machine has been programmed, sign-on will take place only at the beginning of a shift (stay-down), or may have to be repeated for each transaction (pop-up). Normally, if your machine has been programmed for stay-down clerks, the clerk currently signed on must be signed off before another clerk may be signed on. If you have selected the clerk interrupt option, a new clerk can be signed on in the middle of a transaction. In this circumstance, the initial transaction is suspended. When the interrupt transaction is completed, the suspended transaction can be continued.

Check with your store manager to see which options have been selected for your register.

Before any transaction may take place, a clerk must be signed on. Clerk sign-on is accomplished in one of two ways:

Direct Sign-On

If the direct sign-on method is selected, enter the clerk number and press the clerk key.

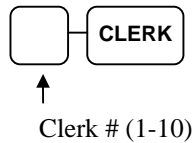

```
DATE 10/15/2002 SUN   TIME 08:37
=====
CLERK LOG IN
=====
CLERK 1                                01
CLERK LOG IN TIME                    09:06
CLERK 1      No.000001    00001
```

To sign the clerk off, enter 0 (Zero) and press the clerk key.



```
DATE 10/15/2002 SUN   TIME 08:37
=====
CLERK LOG OUT
=====
CLERK 1                                01
CLERK LOG OUT OUT                    09:06
CLERK 1      No.000001    00001
```

Coded Sign-On

If the code entry sign-on method is selected, press the clerk key, enter the clerk code, and then press the clerk key again.



Clerk Code (up to 6 digits)

To sign the clerk off, enter 0 (Zero) and press the clerk key.

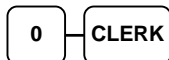

Receipt On and Off

The **RECEIPT ON/OFF** function key may or may not be located on your keyboard. (The **RECEIPT ON/OFF** key is located on the default keyboard.)

If The RECEIPT ON/OFF Key Is Located On The Keyboard

1. Press the **RECEIPT ON/OFF** key once to turn the receipt *off*.
2. Press the **RECEIPT ON/OFF** key again to turn the receipt *on*.

If The RECEIPT ON/OFF Key Is Not Located On The Keyboard

1. Turn the control lock to the **X** position.
2. To turn the receipt *off*, enter **9 9**, press the **SBTL** key. Enter **1**, press **CASH**.



3. To turn the receipt *on*, enter **9 9**, press the **SBTL** key. Enter **0**, press **CASH**.



PLU Registrations

All registrations on *ER-5200M/5240M* are made into open or preset PLUs.

- In place of traditional department keys, NLU (number look up) keys are located directly on the keyboard. NLU keys are programmed to access a specific PLU. In the default configuration NLU key #1 will access PLU #1. See “Program 1000 - NLU Code Number Programming” on page 163 if you wish to change the PLU assigned to a NLU key.
- When more items or categories are needed than the number of PLUs available on the keyboard, registrations can be into PLUs by entering the PLU code number and pressing the **PLU** key on the keyboard, or if an optional scanner is used, items can be registered by scanning the item.

This system simplifies reporting by listing all items (regardless of how they are entered) on the PLU report, while reporting for groups of items or categories is available from the Group report.

NLU (Keyboard PLU) Entries

As you make PLU registrations, you can follow your entries by viewing the display. The digit marked **RPT** counts items as they are repeated or multiplied.

In the following examples:

- PLU1 is programmed for open entries, and is taxable by Tax 1.
- PLU2 is programmed for open entries, and is taxable by Tax 2.
- PLU3 is programmed with a preset price of \$3.00, and is taxable by Tax 1 and Tax 2.
- Tax 1 is programmed at 5%; Tax 2 is programmed at 10%.

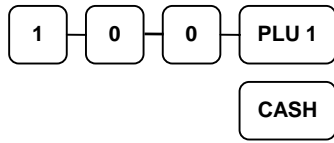

```

DATE 10/15/2002 SUN   TIME 08:37
PLU1 T1                $1.00
TAX1                   $0.05
TOTAL                  $1.05
CASH                   $1.05
CLERK 1                No.000001 00001
  
```

**Open Keyboard
PLU Entry**

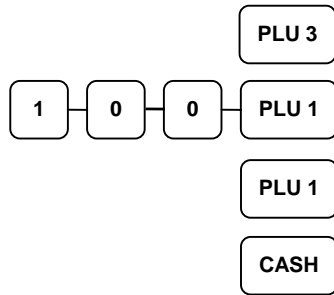

```

DATE 08/15/2002 SUN   TIME 03:15
PLU3 T12               $3.00
PLU1 T1                $1.00
PLU1 T1                $1.00
TAX1                   $0.25
TAX2                   $0.30
TOTAL                  $5.55
CASH                   $5.55
CLERK 1                No.000001 00001
  
```

**Single Preset
PLU**

Single Open PLU

Repeat PLU Item

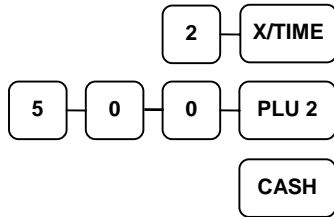

```

DATE 08/15/2002 SUN   TIME 03:15
2X                    @5.00
PLU2 T2               $10.00
TAX2                   $1.00
TOTAL                  $11.00
CASH                   $11.00
CLERK 1                No.000001 00001
  
```

**Multiple Quantity
of a PLU Entry**

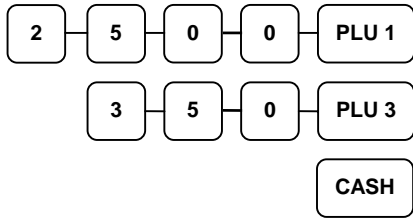

```

DATE 08/15/2002 SUN    TIME 03:15

1X                @25.00
PLU1 T1           $25.00
PLU3 T12         $3.50
TAX1              $1.43
TAX2              $0.35
TOTAL            $30.28
CASH              $30.28
CLERK 1          No.000001 00001
  
```

**HALO Override
on PLU Entry**

**Preset Override
of a Keyboard
PLU**

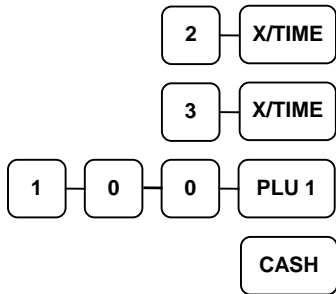

```

DATE 08/15/2002 SUN    TIME 03:15

2@3FOR           @1.00
PLU1 T1           $0.67
TAX1              $0.03
TOTAL            $0.70
CASH              $0.70
CLERK 1          No.000001 00001
  
```

**Split Pricing PLU
Entry**

Numeric PLU Entries

In the following examples:

- PLU510 is programmed open, and is taxable by Tax 1.
- PLU520 is programmed open, and is taxable by Tax 2.
- PLU530 is programmed with a preset price of \$1.50, and is taxable by Tax 1 and Tax 2.
- PLU540 is programmed with a preset price of \$2.50, and is non-taxable.

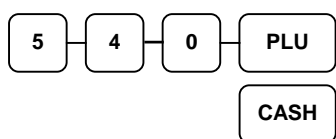

DATE	08/15/2002	SUN	TIME	03:15
PLU540				\$2.50
TOTAL				\$2.50
CASH				\$2.50
CLERK 1	No.000001			00001

Preset PLU Entry

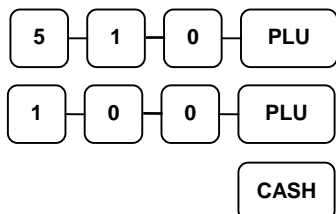

DATE	08/15/2002	SUN	TIME	03:15
PLU510 T1				\$1.00
TAX1				\$0.05
TOTAL				\$1.05
CASH				\$1.05
CLERK 1	No.000001			00001

Single Open PLU Entry

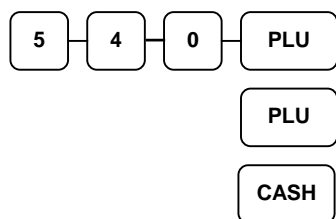

DATE	08/15/2002	SUN	TIME	03:15
PLU540				\$2.50
PLU540				\$2.50
TOTAL				\$5.00
CASH				\$5.00
CLERK 1	No.000001			00001

Single Preset PLU Entry

Repeat Entry

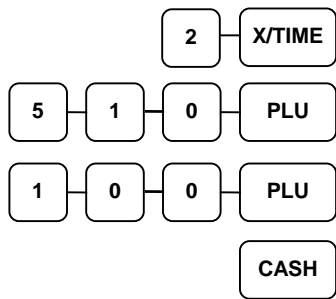

```

DATE 08/15/2002 SUN   TIME 03:15

2X                      @1.00
PLU510 T1                $2.00
TAX1                     $0.10
TOTAL                    $2.10
CASH                     $2.10
CLERK 1                  No.000001  00001
  
```

Multiple Quantity of a Open PLU Entry

Note: PLU program setting must be made to allow this override. Turn Key Lock to the X position

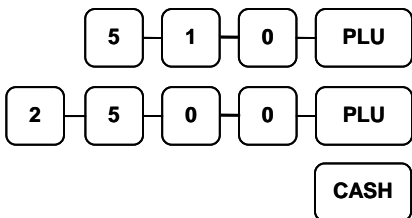

```

DATE 08/15/2002 SUN   TIME 03:15

1X                      @25.00
PLU510 T1                $25.00
TAX1                      $1.25
TOTAL                     $26.25
CASH                      $26.25
CLERK 1                   No.00001  00000
  
```

HALO Override on PLU Entry

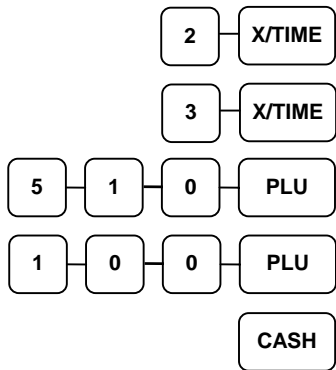

```

DATE 08/15/2002 SUN   TIME 03:15

2@3FOR                  @1.00
PLU510 T1                $0.67
TAX1                     $0.03
TOTAL                    $0.70
CLERK 1                  No.00001  00000
  
```

Split Pricing PLU Entry

Modifier Entries

Pressing a modifier key alters the next PLU registered, either by changing the code number of the PLU so that a different item is registered, or by just adding the modifier descriptor and registering the same PLU. See "Modifier 1-5" in the "Program Mode Programming" chapter in order to determine how the modifier key will affect the PLU entry.

Modifiers can be:

- *stay down* so that registrations will be modified by the same modifier until another modifier is selected,
- *pop-up after each item* to register, for example large, medium or small soft drink,
- *pop-up after each transaction* to register, for example, toppings of various pizza sizes.

See "System Options" in the "Program Mode Programming" chapter to select stay down/pop-up status.

Pop-Up Modifier Key Affecting PLU Code

1. Press a preset PLU key. For example, press PLU 1 with a price of \$1.00.

PLU 1

2. Press the MOD 1 key.

MOD 1

3. Press the same PLU key. In this example the modifier 1 will add the digit 1 to the third PLU # position, resulting in the registration of PLU #101.

PLU 1

4. Press another PLU key. In this example press PLU 2 with a price of \$1.50.

DATE	08/15/2002 SUN	TIME	03:15
PLU1			\$1.00
PLU101			\$2.00
PLU2			\$1.50
TOTAL			\$4.50
CASH			\$4.50
CLERK 1	No.000001		00001

Percentage Key (%) Registrations

There are three percentage keys on the default *ER-5200M* keyboard; there are four percentage keys on the default *ER-5240M* keyboard. Through "Function Key Assignment Programming" (see page 84) up to five percentage keys may be placed on the keyboard. Each key is individually programmable to add or subtract, from an individual item or from a sale total, amounts (coupons) or percentages. You can also program the percentage key taxable or non-taxable, so that sales taxes are calculated on the net, or gross amount of the item or sale.

The operation examples in this section show the percentage key in a variety of configurations. See "%1-%5 Function Key Options" on page 147 to assign a specific function to each percentage key.

<div style="display: flex; align-items: center; gap: 5px;"> <div style="border: 1px solid black; border-radius: 5px; padding: 2px 5px;">1</div> <div style="border: 1px solid black; border-radius: 5px; padding: 2px 5px;">0</div> <div style="border: 1px solid black; border-radius: 5px; padding: 2px 5px;">0</div> <div style="border: 1px solid black; border-radius: 5px; padding: 2px 5px;">PLU 1</div> </div> <div style="margin-top: 10px; border: 1px solid black; border-radius: 5px; padding: 2px 5px; width: fit-content; margin-left: auto;">%1</div> <div style="margin-top: 10px; border: 1px solid black; border-radius: 5px; padding: 2px 5px; width: fit-content; margin-left: auto;">CASH</div>	<pre> DATE 08/15/2002 SUN TIME 03:15 PLU1 T1 \$1.00 % 1 10.000% AMOUNT T1 \$0.10 TAX1 \$0.06 TOTAL \$1.16 CASH \$1.16 CLERK 1 No.000001 00001 </pre>	<p><i>Preset 10% Surcharge on an Item</i></p>
<div style="display: flex; align-items: center; gap: 5px;"> <div style="border: 1px solid black; border-radius: 5px; padding: 2px 5px;">1</div> <div style="border: 1px solid black; border-radius: 5px; padding: 2px 5px;">0</div> <div style="border: 1px solid black; border-radius: 5px; padding: 2px 5px;">0</div> <div style="border: 1px solid black; border-radius: 5px; padding: 2px 5px;">PLU 1</div> </div> <div style="margin-top: 10px; border: 1px solid black; border-radius: 5px; padding: 2px 5px; width: fit-content; margin-left: auto;">SBTL</div> <div style="margin-top: 10px; border: 1px solid black; border-radius: 5px; padding: 2px 5px; width: fit-content; margin-left: auto;">% 1</div> <div style="margin-top: 10px; border: 1px solid black; border-radius: 5px; padding: 2px 5px; width: fit-content; margin-left: auto;">CASH</div>	<pre> DATE 08/15/2002 SUN TIME 03:15 PLU1 T1 \$1.00 % 1 -10.000% AMOUNT T1 -0.10 TAX1 \$0.05 TOTAL \$0.95 CASH \$0.95 CLERK 1 No.000001 00001 </pre>	<p><i>Preset 10% Discount on a Sale</i></p>

1 0 0 0 PLU #1
 1 0 0 0 PLU #4
 SBTL
 % 1
 CASH

DATE 08/15/2002 SUN TIME 03:15
 PLU1 T1 \$10.00
 PLU4 \$10.00
 % 1 10.00%
 AMOUNT T1 \$2.00
 TAX1 \$0.55
 TOTAL \$22.55
 CASH \$22.55
 CLERK 1 No.000001 00001

**Preset 10%
 Surcharge on a
 Sale**

1 0 0 PLU #1
 2 5 % 1
 PLU #1
 CASH

DATE 08/15/2002 SUN TIME 03:15
 PLU1 T1 \$1.00
 PLU1 CT1 -0.25
 TAX1 \$0.04
 TOTAL \$0.79
 CASH \$0.79
 CLERK 1 No.000001 00001

**Store Coupon
 Entry
 (Open Amount
 Discount on an
 Item)**

2 0 0 PLU #1
 2 X/TIME
 1 0 % 1
 PLU #1
 CASH

DATE 08/15/2002 SUN TIME 03:15
 PLU1 T1 \$2.00
 2X @0.10
 PLU1 CT1 -0.20
 TAX1 \$0.09
 TOTAL \$1.89
 CASH \$1.89
 CLERK 1 No.000001 00001

**Multiple Store
 Coupon Entry
 (Open Amount
 Discount on an
 Item)**

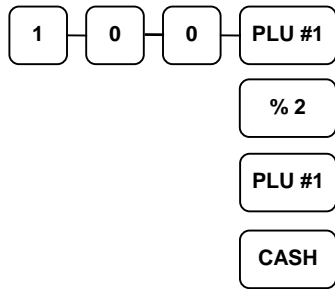

DATE 08/15/2002 SUN TIME 03:15

PLU1 T1	\$1.00
PLU1 CT1	-0.50
TAX1	\$0.03
TOTAL	\$0.53
CASH	\$0.53
CLERK 1	No.000001 00001

**Preset Store
Coupon
(Preset Amount
Discount on an
Item)**

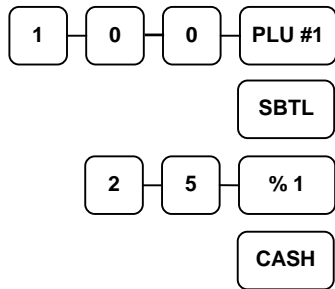

DATE 08/15/2002 SUN TIME 03:15

PLU1 T1	\$1.00
%1 T1	-0.25
TAX1	\$0.04
TOTAL	\$0.79
CASH	\$0.79
CLERK 1	No.000001 00001

**Vendor Coupon
Entry
(Open Amount
Discount on a
Sale)**

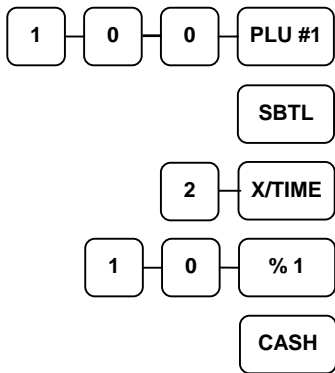

DATE 08/15/2002 SUN TIME 03:15

PLU1 T1	\$1.00
2X @0.10	
%1 T1	-0.20
TAX1	\$0.04
TOTAL	\$0.84
CASH	\$0.84
CLERK 1	No.000001 00001

**Multiple Vendor
Coupon Entry
(Open Amount
Discount on a
Sale)**

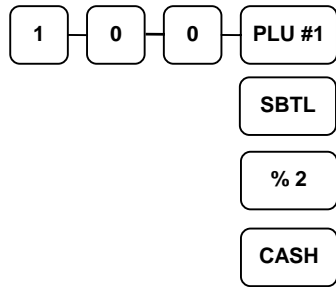

DATE 08/15/2002 SUN		TIME 03:15
PLU1 T1		\$1.00
%1 T1		-0.50
TAX1		\$0.03
TOTAL		\$0.53
CASH		\$0.53
CLERK 1	No.000001	00001

**Preset Vendor
Coupon Entry
(Preset Amount
Discount on a
Sale)**

Void and Correction Operations

Error Correct

The error correct function voids the last item entered, provided no other key has been pressed.

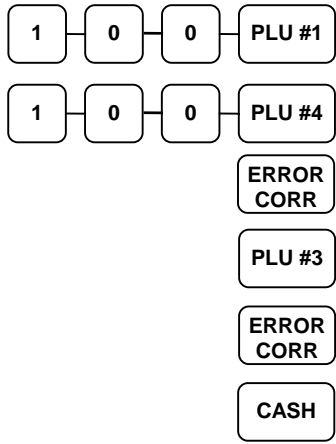

DATE 08/15/2002 SUN		TIME 03:15
PLU1 T1		\$1.00
PLU4		\$2.00
ERRCORR-----		
PLU4		-2.00
PLU3 T12		\$3.00
ERRCORR-----		
PLU3 T12		-3.00
TAX1		\$0.05
TOTAL		\$1.05
CASH		\$1.05
CLERK 1	No.000001	00001

Error Correction

Previous Item Void

The previous item void function allows the correction of any item previously entered in the current transaction.

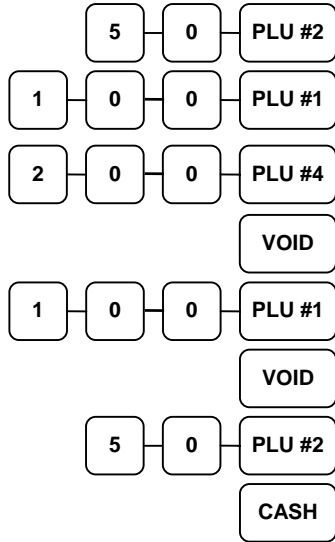

DATE	08/15/2002 SUN	TIME	03:15
PLU2	T2		\$0.50
PLU1	T1		\$1.00
PLU4			\$2.00
VOID	-----		
PLU1	T1		-1.00
VOID	-----		
PLU2	T2		-0.50
TOTAL			\$2.00
CASH			\$2.00
CLERK	1	No.000001	00001

**Previous Item
Void**

Merchandise Return

Merchandise returns may be registered as part of a separate transaction, or as part of a transaction where other merchandise is sold. Press the **RETURN** key before entering the related PLU. Tax is credited if the item being returned is taxable.

			RETURN	DATE 08/15/2002 SUN	TIME 03:15
5	0	0	PLU #1	MDSE RETURN*****	
			RETURN	PLU1 T1	-5.00
			RETURN	MDSE RETURN*****	
		3	X/TIME	3X @2.00	
2	0	0	PLU #4	PLU4	-6.00
			CASH	TAX1	-0.25
				TOTAL	-11.25
				CASH	-11.25
				CLERK 1	No.000001 00001

**Merchandise
Return**

**Multiple Item
Merchandise
Return**

			RETURN	DATE 08/15/2002 SUN	TIME 03:15
1	0	0	PLU #4	MDSE RETURN*****	
			%1	PLU4	-1.00
			CASH	%1	-10.000%
				AMOUNT	\$0.10
				TOTAL	-0.90
				CASH	-0.90
				CLERK 1	No.000001 00001

**Merchandise
Return of
Discounted
Merchandise**

VOID Control Lock Position (Transaction Void)

Most operations that can be performed with the control lock in the REG position, can also be done with the control lock in the **VOID** position. **VOID** position operations will adjust all sale totals, and the **VOID** (Transaction Void) position carries its own total on the Financial report.

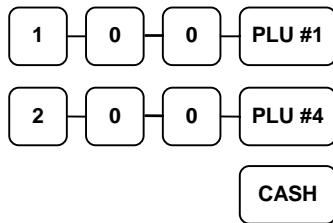

DATE 08/15/2002 SUN		TIME 03:15
PLU1 T1		\$1.00
PLU4		\$2.00
TAX1		\$0.05
TOTAL		\$3.05
CASH		\$3.05
CLERK 1	No.000001	00001

**Original
Transaction**

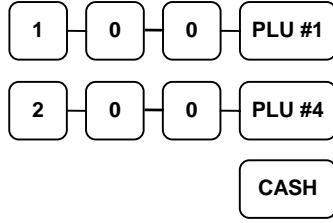

DATE 08/15/2002 SUN		TIME 03:15
VOID MODE*****		
PLU1 T1		-1.00
PLU4		-2.00
TAX1		-0.05
TOTAL		-3.05
CASH		-3.05
CLERK 1	No.000001	00001

**Transaction Void
of Original
Transaction**

Cancel

Press the **CANCEL** key anytime during a transaction to cancel that transaction. (This is not a tender key.) Transactions of up to a maximum of 49 items may be canceled.

The only total affected is the Cancel total, to which the total of all positive entries is added.

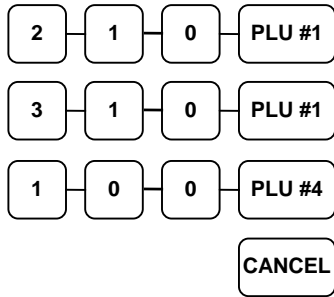

```
DATE 08/15/2002 SUN   TIME 03:15
PLU1 T1                $2.00
PLU1 T1                $3.00
PLU4                   $1.00
CANCEL*****
CLERK 1                No.000001  00001
```

***Canceled
Transaction***

Subtotal Operations

Subtotal

Press the **SBTL** key at anytime during a transaction to view the total due, including tax and after adjustments. The display will indicate **Sub** for subtotal.

Add Check (Tray Subtotal)

In a cafeteria, use the **ADD CHECK** key to add multiple trays that are paid by a single individual (i.e. Dad pays all the trays for the family.)

Press the **ADD CHECK** key after each order, and **SBTL** for the total of all orders. Finalize with any tender key as you would a normal sale.

<table border="1" style="border-collapse: collapse;"><tr><td style="padding: 2px 10px;">4</td><td style="padding: 2px 10px;">0</td><td style="padding: 2px 10px;">0</td><td style="padding: 2px 10px;">PLU #1</td></tr><tr><td colspan="3"></td><td style="padding: 2px 10px; text-align: center;">ADD CHECK</td></tr></table>	4	0	0	PLU #1				ADD CHECK	<table style="width: 100%; border-collapse: collapse;"><tr><td style="width: 30%;">DATE</td><td style="width: 30%;">08/15/2002 SUN</td><td style="width: 20%;">TIME</td><td style="width: 20%;">03:15</td></tr><tr><td>PLU1 T1</td><td></td><td></td><td style="text-align: right;">\$4.00</td></tr><tr><td>TAX1</td><td></td><td></td><td style="text-align: right;">\$0.20</td></tr><tr><td>TOTAL</td><td></td><td></td><td style="text-align: right;">\$4.20</td></tr><tr><td>ADDCHK</td><td></td><td></td><td style="text-align: right;">\$4.20</td></tr><tr><td>CLERK 1</td><td>No.000001</td><td></td><td style="text-align: right;">00001</td></tr></table>	DATE	08/15/2002 SUN	TIME	03:15	PLU1 T1			\$4.00	TAX1			\$0.20	TOTAL			\$4.20	ADDCHK			\$4.20	CLERK 1	No.000001		00001	<p>First Check Added</p>
4	0	0	PLU #1																															
			ADD CHECK																															
DATE	08/15/2002 SUN	TIME	03:15																															
PLU1 T1			\$4.00																															
TAX1			\$0.20																															
TOTAL			\$4.20																															
ADDCHK			\$4.20																															
CLERK 1	No.000001		00001																															
<table border="1" style="border-collapse: collapse;"><tr><td style="padding: 2px 10px;">5</td><td style="padding: 2px 10px;">0</td><td style="padding: 2px 10px;">0</td><td style="padding: 2px 10px;">PLU #1</td></tr><tr><td colspan="3"></td><td style="padding: 2px 10px; text-align: center;">ADD CHECK</td></tr></table>	5	0	0	PLU #1				ADD CHECK	<table style="width: 100%; border-collapse: collapse;"><tr><td style="width: 30%;">DATE</td><td style="width: 30%;">08/15/2002 SUN</td><td style="width: 20%;">TIME</td><td style="width: 20%;">03:15</td></tr><tr><td>PLU1 T1</td><td></td><td></td><td style="text-align: right;">\$5.00</td></tr><tr><td>TAX1</td><td></td><td></td><td style="text-align: right;">\$0.25</td></tr><tr><td>TOTAL</td><td></td><td></td><td style="text-align: right;">\$5.25</td></tr><tr><td>ADDCHK</td><td></td><td></td><td style="text-align: right;">\$5.25</td></tr><tr><td>CLERK 1</td><td>No.000002</td><td></td><td style="text-align: right;">00001</td></tr></table>	DATE	08/15/2002 SUN	TIME	03:15	PLU1 T1			\$5.00	TAX1			\$0.25	TOTAL			\$5.25	ADDCHK			\$5.25	CLERK 1	No.000002		00001	<p>Second Check Added</p>
5	0	0	PLU #1																															
			ADD CHECK																															
DATE	08/15/2002 SUN	TIME	03:15																															
PLU1 T1			\$5.00																															
TAX1			\$0.25																															
TOTAL			\$5.25																															
ADDCHK			\$5.25																															
CLERK 1	No.000002		00001																															
<table border="1" style="border-collapse: collapse;"><tr><td colspan="4" style="padding: 2px 10px; text-align: center;">CASH</td></tr></table>	CASH				<table style="width: 100%; border-collapse: collapse;"><tr><td style="width: 30%;">DATE</td><td style="width: 30%;">08/15/2002 SUN</td><td style="width: 20%;">TIME</td><td style="width: 20%;">03:15</td></tr><tr><td>TOTAL</td><td></td><td></td><td style="text-align: right;">\$9.45</td></tr><tr><td>CASH</td><td></td><td></td><td style="text-align: right;">\$9.45</td></tr><tr><td>CLERK 1</td><td>No.000003</td><td></td><td style="text-align: right;">00001</td></tr></table>	DATE	08/15/2002 SUN	TIME	03:15	TOTAL			\$9.45	CASH			\$9.45	CLERK 1	No.000003		00001	<p>Payment for Both Checks</p>												
CASH																																		
DATE	08/15/2002 SUN	TIME	03:15																															
TOTAL			\$9.45																															
CASH			\$9.45																															
CLERK 1	No.000003		00001																															

Eat-In/Take-Out/Drive Thru Operations

In a restaurant, **EAT-IN**, **TAKE-OUT** and **DRIVE THRU** keys can be set up to provide totals for each type of sale. The **EAT-IN**, **TAKE-OUT** and **DRIVE THRU** keys may also be set up to remove taxes. For example, if your state charges sales tax for food consumed on the premises, while not charging sales tax for food taken home, sales tax can be exempted with the **TAKE-OUT** key. See "DRIVE THRU / EAT IN / TAKE OUT - Function Key Options" on page 134 to set up tax status for these keys.

After registering all items, press **EAT-IN**, **TAKE-OUT** or **DRIVE THRU** (as you would use the Subtotal key), and then finalize the sale as you normally would.

<div style="display: flex; align-items: center; margin-bottom: 10px;"> <div style="border: 1px solid black; border-radius: 5px; width: 30px; height: 30px; display: flex; align-items: center; justify-content: center; margin-right: 5px;">1</div> <div style="border: 1px solid black; border-radius: 5px; width: 30px; height: 30px; display: flex; align-items: center; justify-content: center; margin-right: 5px;">0</div> <div style="border: 1px solid black; border-radius: 5px; width: 30px; height: 30px; display: flex; align-items: center; justify-content: center; margin-right: 5px;">0</div> <div style="border: 1px solid black; border-radius: 5px; padding: 2px 5px; margin-left: 5px;">PLU #1</div> </div> <div style="border: 1px solid black; border-radius: 5px; padding: 2px 5px; margin-bottom: 10px; width: fit-content;">PLU #3</div> <div style="border: 1px solid black; border-radius: 5px; padding: 2px 5px; margin-bottom: 10px; width: fit-content;">EAT IN</div> <div style="border: 1px solid black; border-radius: 5px; padding: 2px 5px; width: fit-content;">CASH</div>	<pre> DATE 08/15/2002 SUN TIME 03:15 PLU1 T1 \$1.00 PLU3 T12 \$3.00 TAX1 \$0.20 TAX2 \$0.30 ==== EATIN ==== TOTAL \$4.50 CASH \$4.50 CLERK 1 No.000001 00001 </pre>	<p>EAT IN Transaction (Tax is Charged)</p>
<div style="display: flex; align-items: center; margin-bottom: 10px;"> <div style="border: 1px solid black; border-radius: 5px; width: 30px; height: 30px; display: flex; align-items: center; justify-content: center; margin-right: 5px;">1</div> <div style="border: 1px solid black; border-radius: 5px; width: 30px; height: 30px; display: flex; align-items: center; justify-content: center; margin-right: 5px;">0</div> <div style="border: 1px solid black; border-radius: 5px; width: 30px; height: 30px; display: flex; align-items: center; justify-content: center; margin-right: 5px;">0</div> <div style="border: 1px solid black; border-radius: 5px; padding: 2px 5px; margin-left: 5px;">PLU #1</div> </div> <div style="border: 1px solid black; border-radius: 5px; padding: 2px 5px; margin-bottom: 10px; width: fit-content;">PLU #3</div> <div style="border: 1px solid black; border-radius: 5px; padding: 2px 5px; margin-bottom: 10px; width: fit-content;">TAKE OUT</div> <div style="border: 1px solid black; border-radius: 5px; padding: 2px 5px; width: fit-content;">CASH</div>	<pre> DATE 08/15/2002 SUN TIME 03:15 PLU1 T1 \$1.00 PLU3 T12 \$3.00 ==== TKOUT ==== TOTAL \$4.00 CASH \$4.00 CLERK 1 No.000001 00001 </pre>	<p>TAKE OUT Transaction (Tax is Removed from Taxable Items)</p>
<div style="border: 1px solid black; border-radius: 5px; padding: 2px 5px; margin-bottom: 10px; width: fit-content;">PLU #3</div> <div style="border: 1px solid black; border-radius: 5px; padding: 2px 5px; margin-bottom: 10px; width: fit-content;">DRIVE THRU</div> <div style="border: 1px solid black; border-radius: 5px; padding: 2px 5px; width: fit-content;">CASH</div>	<pre> DATE 08/15/2002 SUN TIME 03:15 PLU3 T12 \$3.00 ==== DVTHR ==== TOTAL \$3.00 CASH \$3.00 CLERK 1 No.000001 00001 </pre>	<p>DRIVE THRU Transaction (Tax is Removed from Taxable Items)</p>

Tax Shift Operations

When tax shift operations are performed, the shift light on the display will illuminate.

- To charge a tax or taxes on a non-taxable item press the appropriate tax shift key or keys prior to making the non-taxable PLU entry.
- To except a tax or taxes on a taxable item press the appropriate tax shift key or keys prior to making the taxable PLU entry.
- To except a tax or taxes from an entire sale, press the appropriate tax shift key or keys prior to finalizing the transaction.

<div style="display: flex; align-items: center; gap: 5px;"> <div style="border: 1px solid black; border-radius: 5px; padding: 2px 5px;">2</div> <div style="border: 1px solid black; border-radius: 5px; padding: 2px 5px;">0</div> <div style="border: 1px solid black; border-radius: 5px; padding: 2px 5px;">0</div> <div style="border: 1px solid black; border-radius: 5px; padding: 2px 5px;">TAX 1 SHIFT</div> </div>	<table border="0" style="width: 100%;"> <tr> <td colspan="2">DATE 08/15/2002 SUN</td> <td>TIME 03:15</td> </tr> <tr> <td>PLU4 T1</td> <td></td> <td style="text-align: right;">\$2.00</td> </tr> <tr> <td>TAX1</td> <td></td> <td style="text-align: right;">\$0.10</td> </tr> <tr> <td>TOTAL</td> <td></td> <td style="text-align: right;">\$2.10</td> </tr> <tr> <td>CASH</td> <td></td> <td style="text-align: right;">\$2.10</td> </tr> <tr> <td>CLERK 1</td> <td>No.000001</td> <td>00001</td> </tr> </table>	DATE 08/15/2002 SUN		TIME 03:15	PLU4 T1		\$2.00	TAX1		\$0.10	TOTAL		\$2.10	CASH		\$2.10	CLERK 1	No.000001	00001	<p>To Charge Tax On A Non-Taxable PLU</p>
DATE 08/15/2002 SUN		TIME 03:15																		
PLU4 T1		\$2.00																		
TAX1		\$0.10																		
TOTAL		\$2.10																		
CASH		\$2.10																		
CLERK 1	No.000001	00001																		
<div style="display: flex; align-items: center; gap: 5px;"> <div style="border: 1px solid black; border-radius: 5px; padding: 2px 5px;">2</div> <div style="border: 1px solid black; border-radius: 5px; padding: 2px 5px;">0</div> <div style="border: 1px solid black; border-radius: 5px; padding: 2px 5px;">0</div> <div style="border: 1px solid black; border-radius: 5px; padding: 2px 5px;">TAX 1 SHIFT</div> </div>	<table border="0" style="width: 100%;"> <tr> <td colspan="2">DATE 08/15/2002 SUN</td> <td>TIME 03:15</td> </tr> <tr> <td>PLU1</td> <td></td> <td style="text-align: right;">\$2.00</td> </tr> <tr> <td>TOTAL</td> <td></td> <td style="text-align: right;">\$2.00</td> </tr> <tr> <td>CASH</td> <td></td> <td style="text-align: right;">\$2.00</td> </tr> <tr> <td>CLERK 1</td> <td>No.000001</td> <td>00001</td> </tr> </table>	DATE 08/15/2002 SUN		TIME 03:15	PLU1		\$2.00	TOTAL		\$2.00	CASH		\$2.00	CLERK 1	No.000001	00001	<p>To Except Tax On A Taxable PLU</p>			
DATE 08/15/2002 SUN		TIME 03:15																		
PLU1		\$2.00																		
TOTAL		\$2.00																		
CASH		\$2.00																		
CLERK 1	No.000001	00001																		

1 0 0 PLU #1
 2 0 0 PLU #3
 SBTL
 TAX 1 SHIFT
 TAX 2 SHIFT
 SBTL
 CASH

DATE 08/15/2002 SUN TIME 03:15
 PLU1 T1 \$1.00
 PLU3 T12 \$2.00
 TOTAL \$3.00
 CASH \$3.00
 CLERK 1 No.000001 00001

To Except Specific Taxes On Entire Sale

1 0 0 PLU #1
 2 0 0 PLU #3
 SBTL
 TAX EXEMPT
 SBTL
 CASH

DATE 08/15/2002 SUN TIME 03:15
 PLU1 T1 \$1.00
 PLU3 T12 \$2.00
 TOTAL \$3.00
 CASH \$3.00
 CLERK 1 No.000001 00001

To Except Tax On Entire Sale with Pre-Programmed Tax Exempt Key

Tendering Operations

Cash

1 0 0 PLU #1
 2 0 0 PLU #4
 CASH

DATE	08/15/2002 SUN	TIME	03:15
PLU1	T1		\$1.00
PLU4			\$2.00
TAX1			\$0.05
TOTAL			\$3.05
CASH			\$3.05
CLERK 1	No.000001		00001

**Cash Tender
 (exact amount of
 purchase)**

1 0 0 PLU #1
 2 0 0 PLU #4
 SBTL
 4 0 0 CASH

DATE	08/15/2002 SUN	TIME	03:15
PLU1	T1		\$1.00
PLU4			\$2.00
TAX1			\$0.05
TOTAL			\$3.05
CASH			\$4.00
CHANGE			\$0.95
CLERK 1	No.000001		00001

**Cash Tender with
 Change**

Check

1 0 0 PLU #1
 2 0 0 PLU #4
 CHECK

DATE	08/15/2002 SUN	TIME	03:15
PLU1	T1		\$1.00
PLU4			\$2.00
TAX1			\$0.05
TOTAL			\$3.05
CHECK			\$3.05
CLERK 1	No.000001		00001

**Check Tender
 (exact amount of
 purchase)**

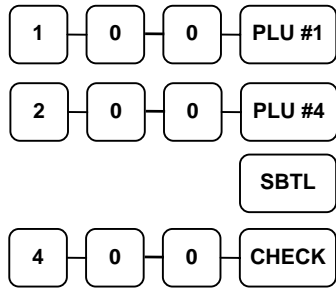

DATE	08/15/2002 SUN	TIME	03:15
PLU1 T1			\$1.00
PLU4			\$2.00
TAX1			\$0.05
TOTAL			\$3.05
CHECK			\$4.00
CHANGE			\$0.95
CLERK 1	No.000001		00001

Check Tender with Change

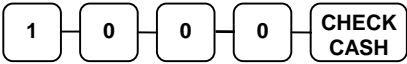

DATE	08/15/2002 SUN	TIME	03:15
*** CHKCASH ***			
CHECK			\$10.00
CASH			-10.00
CLERK 1	No.000001		00001

Check Cashing

Charge

Tendering and over tendering into charge keys is allowed.

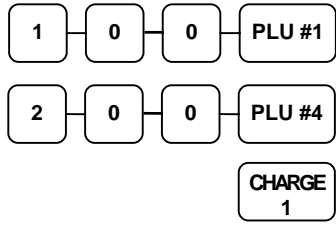

DATE	08/15/2002 SUN	TIME	03:15
PLU1 T1			\$1.00
PLU4			\$2.00
TAX1			\$0.05
TOTAL			\$3.05
CHARGE1			\$3.05
CLERK 1	No.000001		00001

Charge Total

Split Tender

The drawer will not open until the final balance has been paid.

2	0	0	PLU #1
3	0	0	PLU #1
1	0	0	PLU #4
			SBTL
2	0	0	CASH
1	0	0	CHECK
			CHARGE 1

DATE	08/15/2002 SUN	TIME	03:15
PLU1 T1			\$2.00
PLU1 T1			\$3.00
PLU4			\$1.00
TAX1			\$0.25
TOTAL			\$6.25
CASH			\$2.00
TOTAL			\$4.25
CHECK			\$2.00
TOTAL			\$2.25
CHARGE1			\$2.25
CLERK 1	No.000001		00001

**Cash, Check &
Charge
Payments on the
Same
Transaction**

Post Tendering

Post tendering is available for computing change after a sale has been finalized. (See option #6 in "System Option Programming" to enable post tendering.) The second cash entry is compared to the sale total and the difference is displayed. (The **CLEAR** key must first be pressed for registers programmed with pop-up clerks.)

6	0	0	PLU #1	
			SBTL	
			CASH	
1	1	5	0	CASH

DATE	08/15/2002 SUN	TIME	03:15
PLU1 T1			\$6.00
TAX1			\$0.30
TOTAL			\$6.30
CASH			\$6.30
CLERK 1	No.000001		00001

Post Tender

Receipt on Request

If a customer requests a receipt after a sale has been finalized, a second depression of the **CASH** key will issue a complete buffered receipt.

Note: A maximum of 204 items may be registered in one sale.

Training Mode

A training mode is available so that you can operate the cash register without updating totals and counters. Note the following conditions:

- The receipt and journal print the message "TRAINING MODE BEGIN" when training mode is activated.
- The receipt and journal print the message "TRAINING MODE END" when training mode is exited.
- The message "TRAINING MODE" prints on each receipt printed while training mode is active.
- The journal does not print during training mode.
- The total and counter on the financial report labeled "TRAIN TTL" is updated with the net amount of each training transaction.

To Enter Training Mode

- ◆ Set system option #23 to a value of **1**. See "System Option Programming".

To Exit Training Mode

- ◆ Set system option #23 to a value of **0**. See "System Option Programming".

Clerk Interrupt

Clerk interrupt allows you to temporarily suspend a transaction in progress by allowing a new clerk to sign on and register a new transaction. After the new transaction is complete, the original clerk can sign on, the suspended transaction is recalled and may be completed.

You must select either check (table) tracking or clerk interrupt. You cannot use clerk interrupt with a check tracking system.

To Enable Clerk Interrupt

1. Program Clerk Secret Code
2. Set system option #2 to a value of 1. See "System Option Programming".
3. Set system option #26 to a value of 1. See "System Option Programming".

Non-Add Number

With the #/NS key, you can enter a memo number at any time and print the number on the receipt, journal, or validation. The non-adding number is not added to the sale, nor is it added to any register total, except the # key total itself. You can enter a number up of up to 9 digits. For example:

- Enter a number prior to a PLU entry to print a record of the item's SKU number.
- Enter a number prior to a Check tender to print a record of the check number.
- Enter a number prior to a Charge to print a record of the charge account number.

1	2	3	4	5	6	#/NS	DATE 08/15/2002 SUN	TIME 03:15
			2	0	0	PLU #4	NON-ADD#	123456
							PLU4 T1	\$2.00
							TAX1	\$0.10
							TOTAL	\$2.10
							NON-ADD#	1357
							CHECK	\$2.10
							CLERK 1	No.000001 00001

No Sale

Outside of a transaction you can press the #/NS key to open the cash drawer. The number of no sales are counted and reported on the financial report. The no sale function can also be placed under management control, requiring the control key to be in the X position.

#/NS	DATE 08/15/2002 SUN	TIME 03:15
	NOSALE -----	
	CLERK 1	No.000001 00001

Received on Account

Use the **RECD ACCT** key to record payments or loans to the cash drawer. You can enter more than one type of payment to the drawer. The Received on Account function can only be used outside of a transaction.

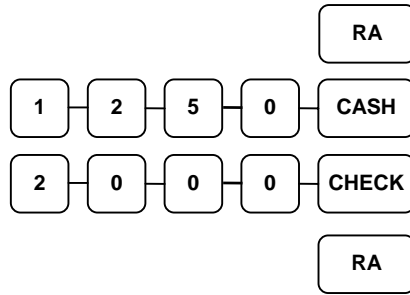

DATE	08/15/2002 SUN	TIME	03:15
RA1			
CASH			\$12.50
CHECK			\$20.00
RA1			\$32.50
CLERK 1	No.00001		00000

Paid Out

Use the **PAID OUT** key to record payments or loans from the cash drawer. You can enter more than one type of payment to the drawer. The Paid Out function can only be used outside of a transaction.

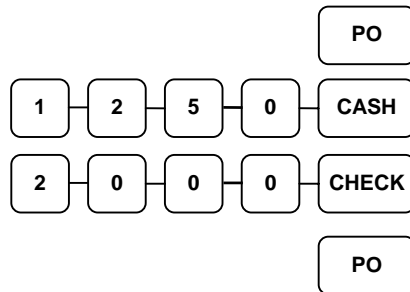

DATE	08/15/2002 SUN	TIME	03:15
PO1			
CASH			\$12.50
CHECK			\$20.00
P/O			\$32.50
CLERK 1	No.00001		00000

Table Service Restaurant Operations

Overview

The *SAM4s ER-5200M/5240M* can be used to add items or receive payments on guest checks using a manual previous balance, hard check, or soft check system. (Note that you must select hard or soft check posting in memory allocation programming. The default selection is soft.)

- If manual previous balance is selected, the check balance is not saved in memory and is input manually by the operator (use the **PBAL** key).
- If a hard check system is selected, only the previous balance is maintained in memory.
- If a soft check system is selected, the check detail is kept in memory until the check is paid. (The maximum size of the soft check is set in memory allocation programming.) When a soft check system is used, the receipt can be used to print the final check that is presented to the customer for payment.

Consolidation of like items can be selected for guest check printing. For example, if three rounds of drinks are served, the check will print "**3 TAP BEER**" rather than "**1 TAP BEER**" three times. (See "Print Option Programming" on page 118.)

Note: If you wish to print guest check transactions on a slip or a pre-printed guest check, an optional printer must be installed. See your *SAM4s* dealer for more information.

Function Keys and Options

Functions necessary for restaurant operations may not appear on the default keyboard. Any or all of the following functions can be located on the keyboard. See "Function Key Assignment Programming" on page 84 if it is necessary to locate these keys on your keyboard.

CHECK #	<p>The CHECK # key is used to begin a new, or access an existing balance (hard check) or itemized bill (soft check.) Existing checks are accessed by entering the check track number and pressing the CHECK# key. The Check # key may be set with the following options:</p> <ul style="list-style-type: none"> • A check must be started before items may be entered. • The clerk that opens the check has exclusive access. • Only one check may be allowed per table. • The check # may be automatically assigned by the register. • Check track numbers that are entered manually may be set at a fixed length of one to nine digits. Check track numbers assigned automatically will begin with #1. <p>In a drive thru system, simply pressing the PBAL key will recall the oldest open balance (lowest check track #).</p>
GUEST	<p>Use to enter the count of guests served as part of a guest check. The entry of a guest count can be enforced when opening a guest check, or for all transactions.</p>
P/BAL	<p>Use to enter the amount of an outstanding balance. The P/BAL key will take the recall function if the <i>drive thru</i> feature is enabled in CHECK # key programming.</p>
SERVICE	<p>Use to temporarily finalize Previous Balance or check tracking transactions. (If you are using a hard check system, you must program the SERVICE key for the port where the slip printer is connected.)</p>
TABLE	<p>You can enforce the entry of a table number for guest check transactions, or for all transactions. If you are tracking guest check balances, the balance can be recalled either by entering the check number or the table number.</p>
PRINT CHECK	<p>Use to print a soft check. The check can be printed on an optional (RS-232C) printer, or can be printed on the receipt printer. The PRINT CHECK key can be set to automatically service the check.</p>
TIP	<p>The TIP key allows a gratuity to be added to a guest check before payment. The tip amount is deducted from the Cash-in-Drawer amount for the Clerk/Cashier closing the guest check.</p> <p>The TIP key may be programmed as either a percentage or amount. If programmed as a percentage, tax programming defines whether the percentage is calculated on the net (taxable = no) amount, or the amount after taxes.</p>

Posting Guest Checks Manually with the Previous Balance Key

The previous balance key is used to enter the amount of the previous balance before adding new items or making payments.

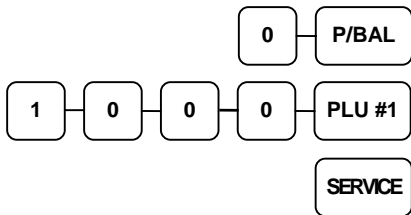

DATE 08/15/2002 SUN	TIME 03:15
PBAL	\$0.00
PLU4	\$10.00
SERVICE	\$10.00
BFW	\$10.00
CLERK 1	No.000001 00001

Starting a Check

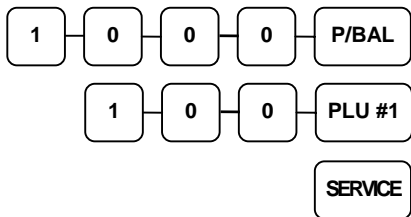

DATE 08/15/2002 SUN	TIME 03:15
PBAL	\$10.00
PLU1 T1	\$1.00
TAX1	\$0.05
SERVICE	\$1.05
BFW	\$11.05
CLERK 1	No.000001 00001

Adding to an Existing Check

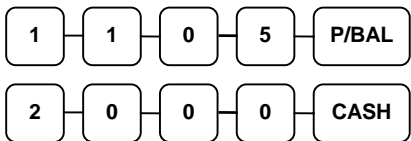

DATE 08/15/2002 SUN	TIME 03:15
PBAL	\$11.05
CHECKS PAID	\$11.05
TOTAL	\$11.05
CASH	\$20.00
CHANGE	\$8.95
CLERK 1	No.000001 00001

Paying a Check

Soft Check

Opening a Soft Check

1. Enter the number of the guest check, press the **CHECK #** key:

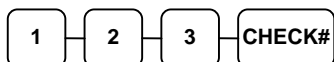

or, press the **CHECK #** key to automatically assign a check:

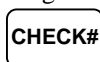

2. If required, enter the table number and press the **TABLE** key:



3. If required, enter the number of guests and press the **GUEST** key:



4. Register the items you wish to sell.
5. To total the posting, press **SERVICE**:



Receipt Example:

DATE	08/15/1999	SUN	TIME	08:33
CHECK #				#123
PBAL				\$0.00
TABLE				#3
GUEST				#2
LIQUOR T1				\$7.00
STEAK T2				\$10.00
TAX1				\$0.35
TAX2				\$1.00
SERVICE				\$18.35
BFWD				\$18.35
CLERK 1	No.000011		00001	

Note: If a table number entry is required for all guest checks, and checks are assigned by register, the check will be assigned by the register when the table # is entered.

Adding to a Soft Check

1. Enter the number of the guest check, press the **CHECK #** key:

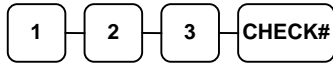

or, if you entered a table number, enter the table number and press the **TABLE** key:



2. Register the next items you wish to sell.
3. To total the posting, press **SERVICE**:



NOTE: Tax are recalculated and printed to reflect total taxes for all items posted on the check.

Receipt Example:

DATE 08/15/1999 SUN	TIME 08:33
CHECK #	#123
PBAL	\$18.19
TABLE	#3
GARLIC BREAD T2	\$2.00
TAX1	\$0.35
TAX2	\$1.20
SERVICE	\$2.20
BFWD	\$20.55
CLERK 1	No.000012 00001

Printing a Soft Check

1. Enter the number of the guest check, press the **CHECK #** key:

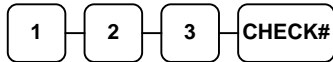

or, if you entered a table number, enter the table number and press the **TABLE** key:



2. Press **PRINT CHECK** to print the complete check. If programmed to do so, the **PRINT CHECK** key will automatically service the check:



Sample of soft check printed on the receipt:

DATE 08/15/1999 SUN	TIME 08:33
CHECK #	#123
LIQUOR T1	\$7.00
STEAK T2	\$10.00
GARLIC BREAD T2	\$2.00
TAX1	\$0.46
TAX2	\$0.87
SERVICE	\$0.00
BFWD	\$20.33
	CHK # : 1
CLERK 1	No.000012 00001

The number of times each check has been printed is counted and printed on the check

Paying a Soft Check

1. Enter the number of the guest check, press the **CHECK #** key:

1 — 2 — 3 — **CHECK#**

or, if you entered a table number, enter the table number and press the **TABLE** key:

3 — **TABLE**

2. If necessary, add additional items. If you wish to add a tip, press **SBTL**, then enter the tip amount and press the **TIP** key:

SBTL

3 — 0 — 0 — **TIP**

3. Pay the balance, as you would normally tender a transaction, with **CASH**, **CHECK**, or one of the **CHARGE** functions. If the tender is greater than the balance due, change is displayed.

2 — 5 — 0 — 0 — **CASH**

Sample of soft check printed on the receipt:

DATE 08/15/1999 SUN TIME 08:33

CHECK #	#123
LIQUOR T1	\$7.00
STEAK T2	\$10.00
GARLIC BREAD T2	\$2.00
TIP	\$3.00
TAX1	\$0.46
TAX2	\$0.87
CHECKS PAID	\$23.33
TOTAL	\$23.33
CASH	\$25.00
CHANGE	\$1.67
	CHK # : 2
CLERK 1	No.000013 00001

Hard Check

Opening a Hard Check

1. Enter the number of the guest check, press the **CHECK #** key:

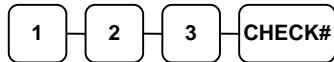

or, press the **CHECK #** key to automatically assign a check:



2. If required, enter the table number and press the **TABLE** key:



3. If required, enter the number of guests and press the **GUEST** key:

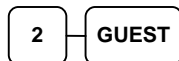

4. Register the items you wish to sell.
5. Place a slip in an optional slip printer, the check will print automatically when you press **SERVICE**:



Receipt Example:

THANK-YOU	
CALL AGAIN	
DATE 08/15/1999 SUN	TIME 08:33
CHECK #	#123
PBAL	\$0.00
TABLE	#3
GUEST	#2
LIQUOR T1	\$7.00
STEAK T2	\$10.00
TAX1	\$0.46
TAX2	\$0.73
SERVICE	\$18.19
BFWD	\$18.19
CLERK 1	No.000011 00001

Adding to a Hard Check

1. Enter the number of the guest check, press the **CHECK #** key:

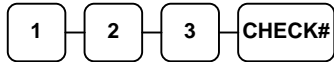

or, if you entered a table number, enter the table number and press the **TABLE** key:



2. Register the next items you wish to sell.
3. To total the posting, press **SERVICE**:



Receipt Example:

DATE 08/15/1999 SUN TIME 08:33

CHECK #	#123
PBAL	\$18.19
TABLE	#3
GARLIC BREAD T2	\$2.00
TAX1	\$0.46
TAX2	\$0.87
SERVICE	\$2.15
BEWD	\$20.33
CLERK 1	No.000012 00001

Paying a Hard Check

1. Enter the number of the guest check, press the **CHECK #** key:

1 — 2 — 3 — **CHECK#**

or, if you entered a table number, enter the table number and press the **TABLE** key:

3 — **TABLE**

2. If necessary, add additional items. If you wish to add a tip, press **SBTL**, then enter the tip amount and press the **TIP** key:

SBTL

3 — 0 — 0 — **TIP**

3. Pay the balance, as you would normally tender a transaction, with **CASH**, **CHECK**, or one of the **CHARGE** functions. If the tender is greater than the balance due, change is displayed.

2 — 5 — 0 — 0 — **CASH**

Sample of Hard Check postings printed on an optional printer:

DATE	12/01/1999	WED
CHECK #		#123
PBAL		\$0.00
LIQUOR T1		\$7.00
STEAK T2		\$10.00
TAX1		\$0.46
TAX2		\$0.73
SERVICE		\$18.19
BFWD		18.19
No.000017 REG 01 ETHAN		TIME 09:15
PBAL		\$18.19
GARLIC BREAD T2		\$2.00
TAX1		\$0.46
TAX2		\$0.87
SERVICE		\$2.15
BFWD		20.33
No.000019 REG 01 ETHAN		TIME 09:47
PBAL		\$20.33
TIP		\$3.00
TAX1		\$0.46
TAX2		\$0.87
CHECKS PAID		\$23.33
CASH		\$25.00
CHANGE		\$1.67
No.000021 REG 01 ETHAN		TIME 10:16

Fast Food Drive Thru

For fast food drive thru windows, the *ER-5200M/5240M* has the capability of storing orders when they are taken, and then recalling the next order automatically at the payment window.

- The **PBAL** function becomes a recall function when the drive thru feature is enabled in the **CHECK #** function key program. Press the **PBAL** key to recall the lowest tracking number balance.
- Orders are stored by first pressing the **CHECK #** key to automatically assign the next tracking number, then pressing **SERVICE**. (A macro sequence key could be created to execute both functions sequentially.)

See "Function Key Programming" on page 124.

Taking a Drive Thru Order

1. Register the items you wish to sell.
2. Press the **CHECK #** key to begin an automatically assigned check:

CHECK#

3. To store the posting, press **SERVICE**:

SERVICE

Receipt Example:

DATE	08/15/1999 SUN	TIME	08:33
HAMBURGER			\$2.00
FRIES			\$1.00
CHECK #			# 3
PBAL			\$0.00
SERVICE			\$3.00
BEWD			\$ 3 . 00
CLERK 1	No.000011		00001

Paying a Drive Thru Order

1. Press the **PBAL** key:

PBAL

2. If necessary, add additional items, register discounts or coupons.
3. Pay the balance, as you would normally tender a transaction, with **CASH**, **CHECK**, or one of the **CHARGE** functions. If the tender is greater than the balance due, change is displayed.

5 — 0 — 0 — **CASH**

Receipt Example:

DATE	08/15/1999 SUN	TIME	08:33
CHECK #			# 3
PBAL			\$3.00
CHECKS PAID			\$3.00
TOTAL			\$3.00
CASH			\$5.00
CHANGE			\$2.00
CLERK 1	No.000012		00001

Promo Function

The **PROMO** key allows the operator to account for promotional items (i.e. buy two, get one free). By design, this key will remove the items cost from the sale, but not the count. In the example of buy two, get one free, the reported count remains three items, but the customer is only charged for two.

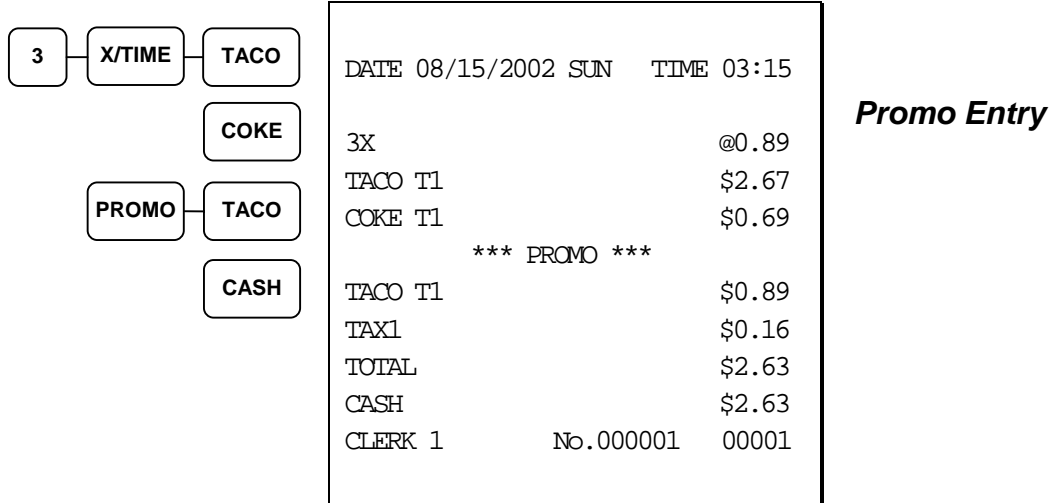

Waste Function

The **WASTE** key allows control of inventory by accounting for items that must be removed from stock due to spoilage, breakage, or mistakes. With manager control, the **WASTE** key requires the control lock to be in the **X** position. The **WASTE** key is not allowed within a sale.

Waste operations begin and end with by pressing the **WASTE** key.

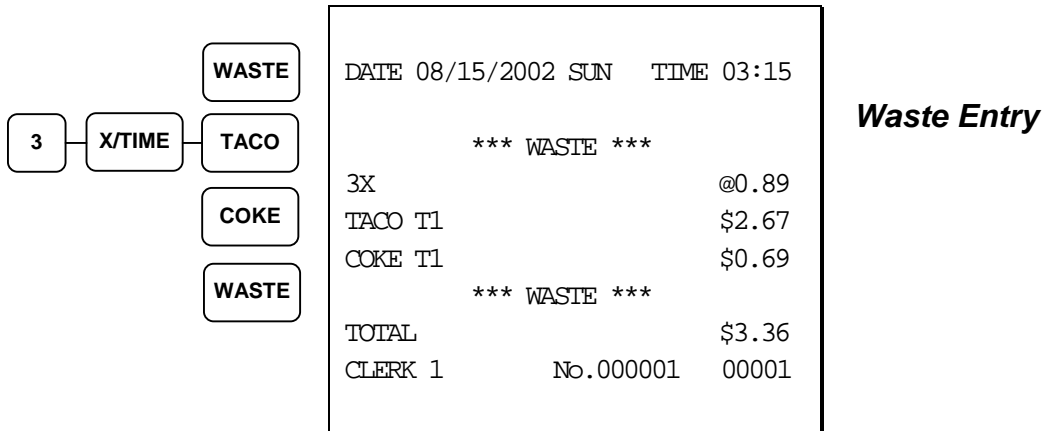

Charge Posting Operations

The ER-5200M/5240M check tracking system can be used to post charges and payments to house accounts. This posting system is ideal for small resorts, camgrounds, motels/hotels or retail stores that accept house charges.

Charge posting features include:

- Manual balance posting, soft check posting, or hard check posting. For house account posting, the hard check posting method with an optional slip printer is recommended. (Because house accounts are usually maintained over a period of time, the soft check system may not have the memory capacity to track the ongoing account activity.)
- Payments can be posted before charges are posted and credit balances can be carried forward.
- Overpayments can be issued as change or carried forward.
- Managers can control access to new account numbers or closing accounts.
- Zero balance accounts can remain active.
- The total of outstanding accounts prints at the end of the open check report and also on the Financial report. (The total is not reset when the financial report is cleared.)
- The total of house account charges (Service Total) and payments are reported to facilitate accounts receivable balancing.

In order to implement this system, you must enable the charge posting features (see “System Option Programming” on page 112”.) You must also assign the necessary function keys for your application.

Charge Posting Function Keys

CHECK # (ACCT #)	The CHECK # key is used to begin a new, or access an existing balance (hard check) or itemized bill (soft check.) Existing checks are accessed by entering the check track number and pressing the CHECK# key. You may wish to reprogram the descriptor of the CHECK # key to ACCT# .
P/BAL	Use to manually enter the amount of an outstanding balance. The P/BAL key is not used when hard or soft check posting is used.
SERVICE (HOUSE CHRG)	Use to temporarily finalize Previous Balance or house account transactions. (If you are using a hard check system, you must program the SERVICE key for the port where the slip printer is connected.) You may wish to reprogram the descriptor of the SERVICE key to HOUSE CHRG .
PAYMENT	Press to make a payment, partial payment, or pre-payment while posting to a check (account). If the payment amount exceeds the check balance, a credit balance will be maintained.
PAY TEND	The PAY TEND key functions like the PAYMENT key, except if the payment amount exceeds the check balance, the overpayment will be issued as change and the account balance will be zeroed.
PRINT CHECK	Use to print a soft check. The check can be printed on an optional (RS-232C) printer, or can be printed on the receipt printer. The PRINT CHECK key can be set to automatically service the check.
FINALIZE	Pressing the FINALIZE key before closing a check will close the account and the account number will no longer be reported on the open check report.

Opening an Account

1. Enter the number of the account and press the **CHECK #** key. You may be required to turn the key lock to the **MGR** position.

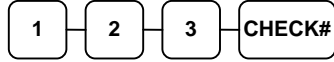

Accepting an Advance Payment

2. Press the **PAYMENT** key.



3. Enter the amount of the payment and press the appropriate tender key; cash, check or charge.

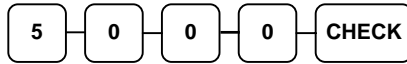

4. Press the **SERVICE** key to finalize and store the balance.



Posting New Charges

5. Enter the number of the account and press the **CHECK #** key.
6. Enter items purchased.
7. Press the **SERVICE** key to finalize and store the balance.

Accepting an Overpayment and Issuing Change

8. Enter the number of the account and press the **CHECK #** key.
9. Press the **PAY TEND** key.



10. Enter the amount of the payment and press the appropriate tender key; cash, check or charge.

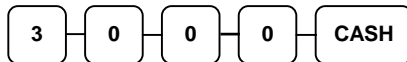

11. Press the **SERVICE** key to finalize and store the balance.

Sample of Hard Check postings printed on an optional printer:

DATE	12/01/1999	WED
CHECK #		#123
PBAL		\$0.00
PAYMENT		\$50.00
CHECK		\$50.00
SERVICE		\$0.00
BFWD		- 50.00
No.000017	REG 01 ETHAN	TIME 09:15
DATE	12/01/1999	WED
PBAL		\$50.00
ROOM		\$75.00
SERVICE		\$75.00
BFWD		25.00
No.000019	REG 01 ETHAN	TIME 09:47
DATE	12/01/1999	WED
PBAL		\$25.00
CHANGE		\$5.00
TENDER		\$30.00
CASH		\$25.00
SERVICE		\$0.00
BFWD		\$0.00
No.000021	REG 01 ETHAN	TIME 10:16

Currency Conversion

If you normally accept currency from a neighboring nation, you can program the *SAM4s ER-5200M/5240M* to convert the subtotal of a sale to the equivalent cost in the foreign currency. Four foreign currency conversion keys are available. See "Function Key Assignment Programming" on page 84 to place currency conversion keys on the keyboard. You also need to program the conversion factor. For example, if the US dollar (home currency) is worth 1.3720 Canadian dollars (foreign currency), the conversion factor is 1.3720. See "Instructions for Currency Conversion Rate - Program 90" on page 127 to set a conversion rate.

Note: The change due is computed in home currency!

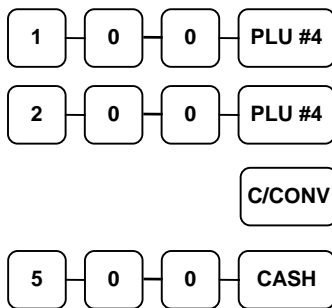

DATE 08/15/2002 SUN	TIME 03:15
PLU1	\$1.00
PLU4	\$2.00
TOTAL	\$3.00
CONV1	@5.00
CHANGE RATE	#1.3720
HOME AMT	\$3.64
CHANGE	\$0.64
CLERK 1	No.000001 00001

**Currency
Conversion
Transaction**

Food Stamp Operations

The SAM4s ER-5200M/5240M can be set up to sort food stamp eligible merchandise and accept food stamp payments. See "Function Key Assignment Programming" on page 84 to place the necessary function keys (**F/S SHIFT**, **F/S SUB**, **F/S TEND**) on the keyboard. You will also need to set food stamp eligibility status for each open or preset PLU (see "Program 100 - PLU Status Programming" on page 99.)

- If necessary, you can use the **F/S SHIFT** key to shift the pre-programmed eligibility status for any item as it is entered. For example, while produce is normally food stamp eligible, certain produce department items, such as birdseed, cannot be paid for with food stamps. In this case, program the produce PLU as food stamp eligible, then press **F/S SHIFT** before registering a non-eligible produce item.
- If a customer chooses to pay with food stamps, press the **F/S SUB** key to display a total of food stamp eligible merchandise.
- Tender food stamp payments into the **F/S TEND** key. Change less than \$1 is given in cash, or applied to non-food stamp eligible items.

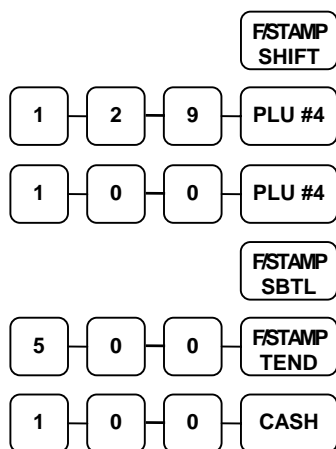

DATE	08/15/2002 SUN	TIME	03:15
PLU1	F		\$1.29
PLU4			\$1.00
TOTAL			\$2.29
F/S TOTAL			\$1.29
F/D TEND			5.00
F/S CRT AMT			\$0.71
TOTAL			\$0.29
CASH			\$1.00
CHANGE			\$0.71
FD/S CHANGE			\$3.00
CLERK 1	No.000001		00001

**Food Stamp
Payment
Transaction**

Scale Operations

The SAM4s ER-5200M/5240M can be interfaced to an optional load-cell scale, allowing direct entry of an item's weight by using the **SCALE** key. If you attempt an entry into a PLU that has been programmed to require scale entry, (see "Program 100 - PLU Status Programming" on page 99) an error tone will sound and you will be prompted to make a scale entry.

Direct Scale Entry

Place a product on the scale and press the **SCALE** key to display the weight on the cash register. Then make the appropriate PLU entry.

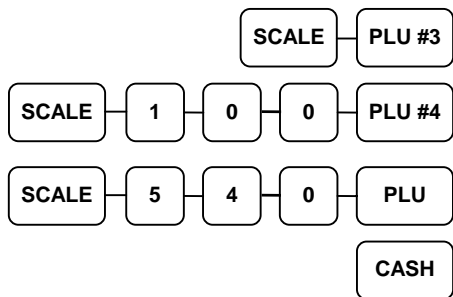

DATE	08/15/2002	SUN	TIME	03:15
1.50 lb	@	3.00		
PLU3	T12			\$4.50
1.75 lb	@	1.00		
PLU 4				\$1.75
1.25 lb	@	2.50		
PLU540				\$3.13
TAX1				\$0.23
TAX2				\$0.45
TOTAL				\$10.06
CASH				\$10.06
CLERK 1	No.	000001		00001

Preset Keyboard PLU

Open Keyboard PLU

Preset PLU

Manual Weight Entry

Operators can make manual weight entries if the item has been programmed to accept them (see "Program 100 - PLU Status Programming" on page 99). You must use the decimal key to enter fractional manual weights.

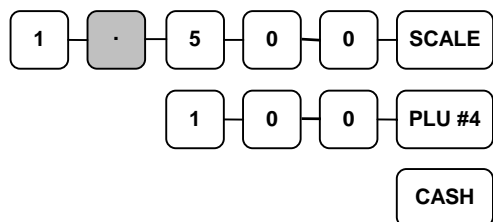

DATE	08/15/2002	SUN	TIME	03:15
1.50 lb	@	1.00		
PLU4				\$1.50
TOTAL				\$1.50
CASH				\$1.50
CLERK 1	No.	000001		00001

Manual Scale Entry

Scale With Automatic Tare Entry

Place a product on the scale, enter the preprogrammed tare number and press the **SCALE** key. The weight, less the tare, will appear on the cash register display. Then make the appropriate PLU entry.

1 — TARE

SCALE

1 — 0 — 0 — PLU #4

CASH

DATE 08/15/2002 SUN TIME 03:15

1.50 lb @ 1.00

PLU4 \$1.50

TOTAL \$1.50

CASH \$1.50

CLERK 1 No.000001 00001

Automatic Tare Entry

Scale With Manual Tare Entry

Tare #5 can be used to manually enter tare weights. Place a product on the scale, enter **5** and press the **SCALE** key. Enter the tare weight (using the decimal key), and press the **SCALE** key. The tare weight will display. Press the **SCALE** key again, and the weight, less the tare will display. Then make the appropriate PLU entry.

5 — TARE

. — 5 — 2 — TARE

SCALE

1 — 0 — 0 — PLU #4

CASH

DATE 08/15/2002 SUN TIME 03:15

1.50 lb @ 1.00

PLU4 \$1.50

TOTAL \$1.50

CASH \$1.50

CLERK 1 No.000001 00001

Manual Tare Entry

Integrated Payment Operations

See Integrated Payment Appendix on page 183 for credit card payment operation information.

Management Functions

Introduction

All Management Functions take place with the control lock in the **X** position. In this way only those with the correct key will have access to these functions. Some register operations may be programmed to require the control lock in the **X** position in order to operate. All reports require a key that will access the **X** or **Z** position.

Cash Declaration

If compulsory cash declaration is required, you must declare the count of the cash drawer prior to taking **X** or **Z** financial and clerk reports.

You can enter the cash drawer total in one step, or to facilitate the counting of the cash drawer, you can enter each type of bill/coin and checks separately and let the register act as an adding machine. You can also use the **X/TIME** key to multiply the denomination of currency times your count.

Either way you choose to enter cash, the register will compare your declaration with the expected cash and check in drawer totals and print the over or short amounts on the report.

For example:

1. Turn the control lock to the **X** or **Z** position (depending upon the type of report you are taking.)

2. Enter **90** and press the **SBTL** key.

9 0 SBTL

3. Enter the total of cash.

9 8 7 6 CASH

4. Enter the total of checks.

2 0 0 0 CHECK

5. Press the **CASH** key to total the declaration.

CASH

DATE	08/15/2002 SUN	TIME	03:15
***	CASH DECLARATION	***	
CASH		\$98.76	
CHECK		\$20.00	
INPUT AMT		\$118.76	
DRAWER TTL		\$23.53	
DIFFERENCE		-95.23	
CLERK 1	No.00001	00000	

Or, enter each denomination separately:

1. Turn the control lock to the **X** or **Z** position (depending upon the type of report you are taking.)

2. Enter **90** and press the **SBTL** key.

9 0 SBTL

3. Enter the total of pennies:

7 6 CASH

4. If you wish you can multiply the count times the denomination. Enter, for example:

3 0 X/TIME

5 CASH

5. Enter the remaining cash separately by denomination.

6. Enter each check:

1 2 0 0 CHECK

8 0 0 CHECK

7. Press the **CASH** key to total the declaration.

CASH

DATE	08/15/2002 SUN	TIME	03:15
***	CASH DECLARATION	***	
CASH		\$0.76	
CASH		\$1.50	
CHECK		\$12.00	
CHECK		\$8.00	
INPUT AMT		\$22.26	
DRAWER TTL		\$23.53	
DIFFERENCE		-1.27	
CLERK 1	No.00001	00000	

System Reports

System reports are divided into two basic categories:

- **X** reports, which read totals without resetting
- **Z** reports, which read totals and reset them to zero

Most reports are available in both categories. Some reports, such as the Cash-in-Drawer report and the From-To PLU report are available only as **X** reports.

Some reports also provide identical but separate *period to date* reports. These reports maintain a separate set of totals which may be allowed to accumulate over a period of days, weeks, months, or even years. **X2** reports read period to date totals without resetting, and **Z2** reports read period to date totals and reset them to zero. Period to date totals are updated each time a **Z1** report is completed.

A complete list of available reports is presented in a chart on the following page.

See “Sample Reports” on page 171 for an example of each report.

Registers programmed with pop-up clerks must be signed on in the **REG** control lock position prior to taking reports.

Running a Report – General Instructions

1. Refer to the “Report Table” on page 36.
2. Select a report type and the report mode.
3. Turn the control lock to the position indicated.
4. Enter the key sequence for the report you have selected.

Report Table

Report Type	Report Number	Report Mode	Control Lock Position	Key Sequence
Financial	1	X	X	1 – SBTL
		Z	Z	1 – SBTL
		X2	X	201 – SBTL
		Z2	Z	201 – SBTL
Time	2	X	X	2 – SBTL
		Z	Z	2 – SBTL
		X2	X	202 – SBTL
		Z2	Z	202 – SBTL
All PLU	3	X	X	3 – SBTL
		Z	Z	3 – SBTL
		X2	X	203 – SBTL
		Z2	Z	203 – SBTL
All Clerk	4	X	X	4 – SBTL
		Z	Z	4 – SBTL
		X2	X	204 – SBTL
		Z2	Z	204 – SBTL
Group	5	X	X	5 – SBTL
		Z	Z	5 – SBTL
		X2	X	205 – SBTL
		Z2	Z	205 – SBTL
All STOCK	6	X	X	6 – SBTL
		Z	Z	6 – SBTL
Daily Sales	8	X2	X	208 – SBTL
		Z2	Z	208 – SBTL
Individual Clerk Report	9	X	X	9-SBTL-#-CLERK-#-CLERK
		X2	X	209-SBTL-#-CLERK-#-CLERK
Open Table/Check	11	X	X	11 – SBTL
		Z	Z	11 – SBTL
From/To PLU	13	X	X	13-SBTL XXXX – PLU – XXXX – PLU
		X2	X	213-SBTL XXXX – PLU – XXXX – PLU
From/To STOCK	14	X	X	14-SBTL XXXX –PLU – XXXX – PLU
DRAWER TOTAL	111	X	X	111-SBTL

S-Mode Programming

Overview

A separate key, marked “C” will access the hidden S key lock position one position clockwise from the P key lock position.

Caution: For information security, distribute the “C” key only to owners or managers who will need to use these procedures.

The following secure procedures are performed in the S-Mode.

- Self Tests
- Clearing Memory
- EPROM Information
- Memory Allocation
- Function Key Assignment Programming
- ER-5240M Keyboard Expansion
- RS-232 Communication Option Programs

Clearing Memory

Before you use your ER-5200M/5240M for the first time, you must perform a memory all clear to insure that all totals and counters are cleared and that the default program is installed.

CAUTION: The procedures described in this area are security sensitive. Clearing the ER-5200M/5240M memory after the register is put into service will erase all programming as well as totals and counters. Do not share this information with unauthorized users and distribute the special SERVICE-Mode key only to those you may want to perform these functions.

Memory All Clear

1. Turn the power switch located on the right side of the register to the **OFF** position.
2. Turn the control lock to the **S** position.
3. Press and hold the key position where the **CHECK** key is located on the default keyboard layout.
4. Continue to hold the **CHECK** key while turning the power switch to the **ON** position.
5. Press the upper left key of the keyboard, then the lower left key, then the upper right key, and finally press the lower right key.

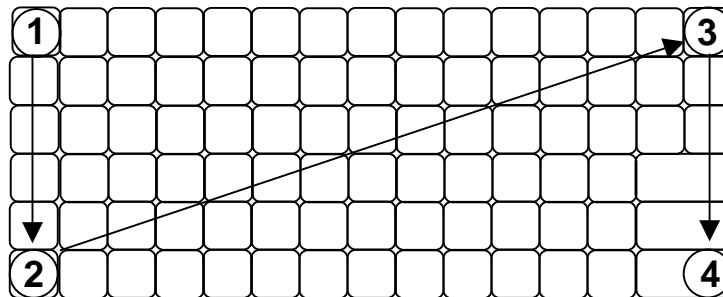

6. After a short delay, the printer will print the message: "RAM ALL CLEAR OK !" and "OK" or "NG" for each of the four possible RAM locations. The default configuration includes RAM 1 & 2 only, therefore RAM 3 & 4 will indicate "NG" unless expansion RAM is added. Memory is cleared and the default program is installed.

Caution: After memory is cleared, the default program will set the register in the 15 key configuration. If you are using 40 NLU keys, see "ER-5240M Keyboard Expansion" on page 85 to reset the 40 key configuration.

Clear All Totals and Counters

1. Turn the control lock to the **S** position.
2. Enter **20** and press the **SBTL** key.

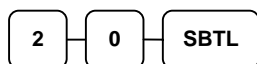

Clear Grand Total

1. Turn the control lock to the **S** position.
2. Enter **30** and press the **SBTL** key.

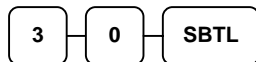

Clear PLU File

1. Turn the control lock to the **S** position.
2. Enter **40** and press the **SBTL** key.

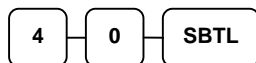

Self Tests

Self-tests can be performed to check the functions of the register.

1. Turn the control lock to the **S** position.
2. Enter the test number from the chart below and press the **SBTL** key.



Test	Key Sequence	Results/Instructions
Printer	10 SBTL	The receipt printer generates a printer test pattern.
Display	11 SBTL	Displays illuminate a test pattern.
Keyboard	12 SBTL	Press any key. The key's hex value is displayed. Turn key lock to end the test.
Mode Lock	13 SBTL	Turn the mode lock to display the lock position. Return the key to S to end the test.
RS232C Port 1	14 SBTL	Loop back connector must be connected. Displays "232 Port Good" if successful; displays "232 Port No Good" if unsuccessful.
RS232C Port 2	24 SBTL	Loop back connector must be connected. Displays "232 Port Good" if successful; displays "232 Port No Good" if unsuccessful.
Endless Printing	15 SBTL	The receipt prints a sample ticket. The print is repeated until the key lock is turned.

EPROM Information

The ER-5200M/5240M register software is loaded in an EPROM (erasable programmable read only memory). This procedure will provide a receipt with the current version, date and checksum for the EPROM.

1. Turn the control lock to the **S** position.
2. Enter **50** and press the **SBTL** key.

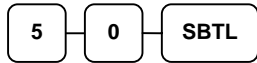

3. After a short delay, the register will print a receipt as in the example below:

```
DATE 10/15/2002 SUN   TIME 08:37

ER-5200M EPROM INFO.
VERSION   : 3.0 USA
CHECKSUM  : 3DC6
BOOT/APP  : 3706/06C0
MARCH 31 2004

CLERK 1           No.000001   00001
```

Memory Allocation

The memory allocation program determines how memory is divided to support the following features:

- PLUs - you must allocate a minimum of 117 PLUs, the maximum is determined by available memory.
- Clerks – you must allocate at least 1 clerk, with a maximum of 99. (Note you also must allocate at least one guest check for each clerk.)
- Groups – you must allocate at least 1 group, with a maximum of 99.
- Guest Checks – you can allocate a maximum of 500 hard or soft checks
- Soft Check Lines – you can allocate a maximum of 50 lines per check
- Check Type – select hard or soft checks
- Mix & Match Discount Tables – you can allocate a maximum of 99

NOTE: Using the clerk interrupt feature requires allocation of at least one guest check for each clerk and sufficient soft check lines to support the interrupted transaction (i.e. if 20 soft check lines are allocated, a transaction with up to 20 lines can be interrupted.) See system option flag # 26 to select clerk interrupt operations instead of table management (check tracking) operations.

Memory Expansion

One or two expansion RAM memory chips can be added. Total Available memory bytes:

Default 187,144

With 1 expansion RAM 711,432

With 2 expansion RAM 1,235,720

Memory Calculation Worksheet

Before beginning the memory allocation program, you may wish to complete the following memory worksheet to verify that the memory variables you wish to use will be accommodated in the ER-5200M/5240M memory. Your memory calculation cannot exceed 187,144 bytes with default memory.

Variable	Bytes per unit	x Quantity	= Total
PLU	78		
Clerks	1,705		
Groups	47		
Guest Check	494		
Lines per Soft Check	38		
Mix & Match	25		
Total Used			
Total Available			187,144 (default)

Memory Calculation Example

The default memory allocation is shown below as a calculation example:

Variable	Bytes per unit	Default Quantity	Total
PLU	78	1000	78,000
Clerks	1705	15	25,575
Groups	47	20	940
Guest Check	494	20	9,880
Lines per Soft Check	38	50 x 20 (guest check quantity)	38,000
Mix & Match	20	25	500
Total Used			152,895
Total Available			187,144

The total memory used must be less than the total memory available

Memory Allocation Program

Once you have determined the memory variable you wish to set, you can set them in the memory allocation program. If you attempt to allocate more options than memory, the message “MEMORY ALLOCATION SIZE OVER” will print on the receipt and journal.

1. Turn the control lock to the **S** position.
2. To Allocate Memory, enter **6 0** and press the **SBTL** key.

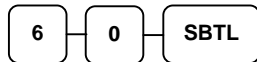

3. Refer to the chart below and enter a digit to represent allocated area and press the **X/TIME** key.

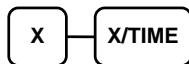

X	Allocated Area
1	PLU
2	CLERK
3	GROUP
4	CHECK#
5	SOFT CHECK LINES
6	CHECK TYPE : Hard(1), Soft(0)
7	MIX & MATCH

4. Enter the desired allocation.

Note for the CHECK TYPE entry: enter **0** for soft check or enter **1** for hard check.



5. Repeat from step 3 to allocate another area, or press the **CASH** key to finalize the program. If the allocation is accepted, the printer will print the new allocation. If the allocation is not accepted, the message “ALLOCATION OVER . . .” will display.



Memory Allocation Program Scan

You can read the current memory allocation with the following sequence:

1. Turn the control lock to the **S** position.
2. Enter **6 0**, press the **SBTL** key and then press the **CASH** key.



```
DATE 04/02/2004 FRI    TIME 08:37

=====
TTL AVALI  : 187144
TTL USED   : 152895
-----
1.ALLOCATED PLU IS :1000
2.ALLOCATED CLERK IS :15
3.ALLOCATED GROUP IS :20
4.ALLOCATED CHECK IS :20
5.ALLOCATED CHK LINE IS :50
6.ALLOCATED HARD(N),SOFT(Y):Y
7.ALLOCATED M&M IS :20
=====
CLERK 1          No.000001  00001
```

Function Key Assignment Programming

Function keys may be relocated, inactivated or changed with this program. For example, you may wish to place functions, such as **PREVIOUS BALANCE** and **SERVICE**, which are not placed on the default keyboard. Or perhaps, you may wish to remove a function, such as **CANCEL**, for security reasons.

Please note the following limitations:

- If you assign a duplicate of a function code, the duplicate will function exactly as the original - you will not get separate totals and counters on reports for the duplicated key.
- You can reassign keys only in locations that are programmable. See "Keyboards" on page 16, where the key locations that may be programmed are identified.

To Assign a Function Key to a Location

1. Turn the control lock to the **S** position.
2. Enter **7 0** and press the **SBTL** key.

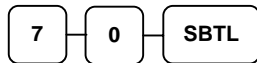

3. Refer to page 82 to find the code for the key you wish to assign. Enter the code and press the location you wish to program. Repeat this step to assign another key.



Key Code

4. Press the **CASH** key to finalize key assignment programming.

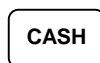

Function Key Codes

Code	Function	Code	Function	Code	Function	Code	Function
1	NLU 1	144	CHARGE 3	170	MACRO 3	196	SERVICE
117	NLU 117	145	CHARGE 4	171	MACRO 4	197	TABLE #
120	Numeric 1	146	CHARGE 5	172	MACRO 5	198	TARE
121	Numeric 2	147	CHARGE 6	173	MACRO 6	199	TAKE OUT
122	Numeric 3	148	CHARGE 7	174	MACRO 7	200	TAX EXEMPT
123	Numeric 4	149	CHARGE 8	175	MACRO 8	201	TAX SHIFT 1
124	Numeric 5	150	CHECKCASHING	176	MACRO 9	202	TAX SHIFT 2
125	Numeric 6	151	CHECKENDORSE	177	MACRO 10	203	TAX SHIFT 3
126	Numeric 7	152	CHECK	178	MDSE RETURN	204	TAX SHIFT 4
127	Numeric 8	153	CHECK #	179	MODIFIER 1	205	TIP
128	Numeric 9	154	CLEAR	180	MODIFIER 2	206	VOID
129	Numeric 0	155	CLERK	181	MODIFIER 3	207	WASTE
130	Numeric 00	156	CURR.CONV.1	182	MODIFIER 4	208	VALIDATION
131	DECIMAL	157	CURR.CONV.2	183	MODIFIER 5	209	RCPT ON/OFF
132	#/NS	158	CURR.CONV.3	184	P/BAL	210	DETAIL FEED
133	%1	159	CURR.CONV.4	185	PAID OUT 1	211	INACTIVE
134	%2	160	DRIVE THRU	186	PAID OUT 2	212	NON ADD
135	%3	161	EAT-IN	187	PAID OUT 3	213	FINALIZE
136	%4	162	ERROR CORR	188	RECT FEED	214	PAYMENT
137	%5	163	F/S SHIFT	189	PRINT CHECK	215	PAY TEND
138	XTIME	164	F/S SUB	190	PROMO		
139	ADD CHECK	165	F/S TEND	191	REC ON ACCT 1		
140	CANCEL	166	GUEST #	192	REC ON ACCT 2		
141	CASH	167	PLU	193	REC ON ACCT 3		
142	CHARGE 1	168	MACRO 1	194	SBTL		
143	CHARGE 2	169	MACRO 2	195	SCALE		

ER-5240M Keyboard Expansion

The default ER-5240M can be expanded from 15 to 40 NLU keys. This program sequence must be performed to activate the expanded keyboard.

Caution: After memory is cleared, the default program will set the ER-5240M register in the 15 key configuration. If you are using 40 NLU keys, you must use this program to reset the 40 key configuration.

1. Turn the control lock to the **S** position.
2. Enter **9 0 0** and press the **SBTL** key.



3. For 15 NLU keys, enter **0** and press the **CASH** key.

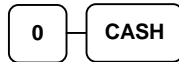

For 40 NLU keys, enter **1** and press the **CASH** key.



4. Press the **CASH** key to finalize.

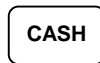

RS-232 Communication Option Programs

You must define the device(s) attached to the RS-232C communications ports, and the options for the device(s).

1. Turn the control lock to the **S** position.
2. Enter **8 0** (enter **8 1** to program the second port) and press the **SBTL** key.
3. Refer to the chart RS-232C option chart that follows and enter the number of the option (N1) you wish to program and press the **X/TIME** key.
4. Enter the value (N2) that represents your selection and press the **CASH** key.
5. Repeat from step 2 for any additional options you wish to program.
6. Press **CASH** to exit the program.

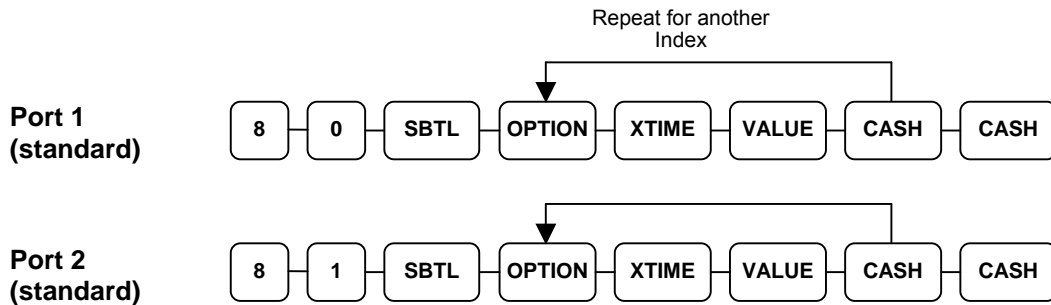

RS-232 Option Chart

Address	Option	Value	Selection
1	Baud Rate	0	9600 BPS
		1	1200 BPS
		2	2400 BPS
		3	4800 BPS
		4	19200 BPS
2	Parity	0	NONE
		1	ODD
		2	EVEN
3	Data Bits	0	8 BITS
		1	7 BITS
4	Stop Bits	0	1 BIT
		1	2 BIT

Address	Option	Value	Selection
5	Device Function	0	NONE
		1	PC
		2	SCALE
		3	Remote Journal (TVS Interface)
		4	Remote Printer
		5	EFT Device
		6	Scanner
		7	COIN
		8	Berg Liquor Dispenser
		9	Pole Display
6	Initial Feeding Line KP	0 - 20	
7	End Feeding Line KP	0 - 20	
8	Initial Feeding Line Slip	0 - 20	
9	Print Line On Guest Check	0 - 50	
10	Scale Type	0	NCI
		1	CAS
11	Printer Type	0	NONE
		1	SRP-100/SAM4S ELLIX10
		2	SRP-270/SRP-500 SAM4S ELLIX20
		3	SRP-300
		4	SRP-350
		5	CITIZEN 3550
		6	CITIZEN 810
		7	CITIZEN 230
		8	EPSON TM T88-2
		9	EPSON U200
		10	EPSON U295
		11	EPSON U300
		12	EPSON U325
		13	EPSON U375
		14	STAR SP-200
		15	STAR SP-298
		16	STAR SP-300
17	STAR TSP-200		
12	Display Type	0	EPSON
		1	ICD

Note: If both ports are set to the same device, Port 1 runs first. For example, if you wish to use Port 2 for PC, Port 1 must be set to another device, or None.

Updating Firmware Program

The ER-5200M/5240M firmware program is loaded in flash EPROM. Occasionally, CRS/*SAM4s* may provide updates to the firmware in order to fix bugs and/or update the register feature set. The firmware program can be transferred from a PC to an ER-5200M/5240M through the register's RS-232C ports.

Note: There are two parts to the firmware program: Boot area and Program area. In most cases, you will only need to update the program area. You will be notified where updates are required.

Update Files

To complete the firmware update, you will be supplied with the following files:

- Download.exe (The update utility program)
- ER5200M.bin and/or ER5240M.bin

PC Connection Cable

Use one of the following cables:

- CRS Part # 522035 (Register DB-9M to PC DB-9F)
- CRS Part # 522038 (Register DB-9M to PC DB-25F)

Part # 522035

SAM4s DB-9M	PC DB-9F
DCD1	1DCD
RXD2	2RXD
TXD3	3TXD
DTR4	4DTR
GND5	5GND
DSR6	6DSR
RTS7	7RTS
CTS8	8CTS
VCC9	9RI

Part # 522038

SAM4s DB-9M	PC DB-25F
DCD1	1ChGND
RXD2	2TXD
TXD3	3RXD
DTR4	4RTS
GND5	5CTS
DSR6	6DSR
RTS7	7GND
CTS8	8DCD
VCC9	20DTR

Update Program Area

1. Connect the Serial Cable From ECR to PC.
2. At the register, turn the control lock to the **S** position.
3. Turn the power switch to the **OFF** position.
4. Press and hold the **CASH** key.
5. While continuing to hold the **CASH** key, turn the power switch to the **ON** position. (The display will show nothing and the error tone will sound.) Release the **CASH** key.
6. Press **CLEAR**.
7. At the PC, execute the program "Download.exe". The Download dialog box displays.

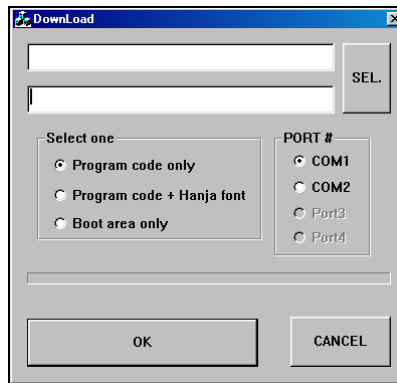

8. Select the appropriate com port connection at your PC at the PORT# option buttons.
9. Click **SEL.** find the folder where the update files are located and select ER5200M.bin or ER5240M.bin.
10. Select **Program code only** in the Select One option buttons.
11. Press **OK** Button. The download takes about 1-2 minutes; the scroll bar will track the progress of the download.
12. The message **Completed** displays. Click **OK** and the Download program will close.
13. At the register, turn the power switch to the **OFF**.
14. See "Clearing Memory" on page 78 and perform a memory all clear in order to install the default program.

Update Boot Area

Note: There are two parts to the firmware program: **Boot area** and **Program area**. In most cases, you will only need to update the program area. You will be specifically notified when **Boot area** updates are required.

1. Connect the Serial Cable From ECR to PC.
2. At the register, turn the control lock to the **S** position.
3. Turn the power switch to the **OFF** position.
4. Press and hold the **CASH** key.
5. While continuing to hold the **CASH** key, turn the power switch to the **ON** position. (The display will show nothing and the error tone will sound.) Release the **CASH** key.
6. Press **CLEAR**.
7. At the PC, execute the program "Download.exe". The Download dialog box displays.

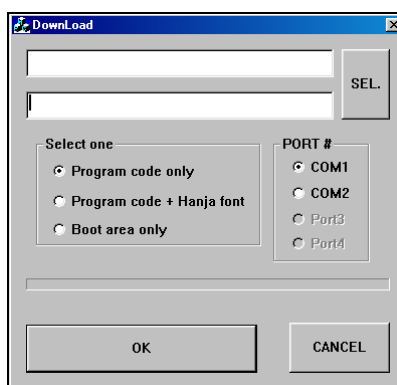

8. Select the appropriate com port connection at your PC at the PORT# option buttons.
9. Click **SEL.** find the folder where the update files are located and select ER5200M.bin or ER5240M.bin.
10. Select **Boot area only** in the Select One option buttons.
11. Press **OK** Button. The download takes about 15 seconds; the scroll bar will track the progress of the download.
12. The message **Completed** displays. Click **OK** and the Download program will close. At the register, turn the power switch to **OFF**.

P-Mode Programming

Default Program

The *ER-5200M/5240M* arrives with a default or generic program already installed. Program options are set to **0** (Zero), unless otherwise noted, which means the machine can be operated immediately after a RAM clear procedure is performed.

For example:

- All keyboard PLUs are nontaxable and open, without entry limits by default status programming of "00000000".
- All system options are set to **0** in default programming, unless otherwise noted. Change only the options that will deviate from default programming. There is no need to re-enter an option status of **0**, since **0** is its original setting.
- All programming (unless otherwise noted) is done with the control lock in the **P** position. Each section details a specific area of register programming.

Tax Programming

The *ER-5200M/5240M* has the capability to support four separate taxes.

Taxes can be calculated as either a straight percentage rate of between .001% and 99.999%, or a 60 break point tax table. Each tax may be either an add-on tax (added to the cost of a taxable item), or a value added tax (VAT) that is included in the price of the item.

Tax rate 4 may be set to function as the Canadian Goods & Services Tax (GST). **If Tax 4 is designated as GST, table programming for the rate is not allowed.**

Definitions for tax rates 1, 2, 3 & 4 are made as part of tax programming.

- If you are entering a tax rate (add-on or VAT), see "Straight Percentage Tax Rate Programming" to enter the percentage rate.
- If you are entering a tax table, see "Tax Table Programming" to enter the tax break points.
- If you are entering a Canadian Goods and Services Tax (GST), use tax rate 4 for the GST tax, and use tax rates 1, 2 and/or 3 for any other provincial tax or taxes. See "Straight Percentage Tax Rate Programming" to enter the GST status and percentage rate.

Important Note: After you have entered your tax program(s), test for accuracy by entering several transactions of different dollar amounts. Carefully check to make sure the tax charged by the cash register matches the tax on the printed tax chart for your area. As a merchant, you are responsible for accurate tax collection. If the cash register is not calculating tax accurately, contact your dealer for assistance.

Straight Percentage Tax Rate Programming

When tax requirements may be met using a straight percentage rate, use the following method to program a tax as a straight percentage.

Programming Straight Percentage Tax Rates and Status

1. Turn the control lock to the **P** position.
2. If the tax is a percentage rate, with a decimal. (0.000-99.999). It is not necessary to enter preceding zeros. For example, for 6%, enter 06.000 or 6.000.
3. For the type of tax:

If the tax is a percentage added to the sale (normal add on tax), enter:	0
If the tax is a percentage value added tax (VAT; calculated as part of the sale), enter:	2

4. Enter **0** here for all taxes, unless if you are programming tax 4 as a Canadian GST. If tax 4 is a Canadian GST, enter the sum of the options below:

OPTION	VALUE	=	SUM
GST (tax 4) is taxable by rate 1?	Yes = 1 No = 0		
GST (tax 4) is taxable by rate 2?	Yes = 2 No = 0		
GST (tax 4) is taxable by rate 3?	Yes = 4 No = 0		

5. Press the Tax Shift key for the tax you are programming.
6. Press the **CASH** key to end programming.

Tax Rate Programming Flowchart

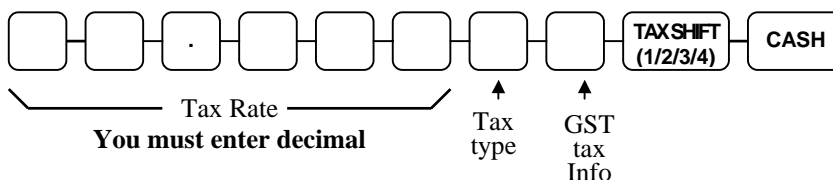

Tax Table Programming

In some cases, a tax that is entered as a percentage does not follow exactly the tax charts that apply in your area (even if the tax chart is based on a percentage). In these cases, we recommend that you enter your tax using tax table programming. This method will match tax collection exactly to the break points of your tax table.

Before programming, obtain a copy of the tax table you wish to program. You will need the printed tax table if you wish to determine the break point entries yourself.

Note: You can enter up to 60 break points.

Determining Break Point Entries

1. Examine the printed tax table for the tax you are programming.
2. Refer to the “Tax Table Programming Example - Illinois 6% Tax Table” to help with this exercise.
3. Calculate the break point differences by subtracting the high side of the previous range from the high side of the dollar range.
4. Examine the pattern of break point differences to determine when the break points begin to repeat. Mark the beginning break points that do not fit a pattern as “non-repeat breaks.” Mark the break points that are repeating in a pattern as “repeat breaks.”

Programming a Tax Table

1. Turn the control lock to the **P** position.
2. Enter **10**; press the **TAX SHIFT** key for the tax you are programming, i.e. **TAX SHIFT 1**, **TAX SHIFT 2**, **TAX SHIFT 3** or **TAX SHIFT 4**.
3. Enter the maximum amount that is not taxed and press the appropriate **TAX SHIFT** key.
4. Enter the first tax amount charged and press the appropriate **TAX SHIFT** key.
5. For each non-repeat break point, up to the last non-repeat break point, enter the high side from the sale dollar range and press the appropriate **TAX SHIFT** key.
6. For the last non-repeat break point, enter the high side from the sale dollar range and press the **X/TIME** key.
7. For each repeat break point, enter the high side from the sale dollar range and press the appropriate **TAX SHIFT** key.
8. Press the **CASH** key to end the tax table program.

Tax Table Programming Example - Illinois 6% Tax Table

<u>Tax Charged</u>	<u>Sale Dollar Range</u>	<u>Break point Differences</u>	
\$0.00	\$0.00 - \$0.10		
\$0.01	\$0.11 - \$0.21	11	Non-Repeat
\$0.02	\$0.22 - \$0.38	17	
\$0.03	\$0.39 - \$0.56	18	
\$0.04	\$0.57 - \$0.73	17	
\$0.05	\$0.74 - \$0.91	18	
\$0.06	\$0.92 - \$1.08	17	
\$0.07	\$1.09 - \$1.24	16	Repeat
\$0.08	\$1.25 - \$1.41	17	
\$0.09	\$1.42 - \$1.58	17	
\$0.10	\$1.59 - \$1.74	16	
\$0.11	\$1.75 - \$1.91	17	
\$0.12	\$1.92 - \$2.08	17	
\$0.13	\$2.09 - \$2.24	16	
\$0.14	\$2.25 - \$2.41	17	

To enter the sample program for the Illinois 6% tax table in tax 1:

1. Enter **1 0** press the **TAX SHIFT 1** key.
2. Enter **1 0** (the maximum amount that is not taxed), press the **TAX SHIFT 1** key.
3. Enter **1** (the first tax amount charged), press the **TAX SHIFT 1** key.
4. Enter **2 1** (non-repeat break point), press the **TAX SHIFT 1** key.
5. Enter **3 8** (non-repeat break point), press the **TAX SHIFT 1** key.
6. Enter **5 6** (non-repeat break point), press the **TAX SHIFT 1** key.
7. Enter **7 3** (non-repeat break point), press the **TAX SHIFT 1** key.
8. Enter **9 1** (non-repeat break point), press the **X/TIME** key.
9. Enter **1 0 8** (repeat break point), press the **TAX SHIFT 1** key.
10. Enter **1 2 4** (repeat break point), press the **TAX SHIFT 1** key.
11. Enter **1 4 1** (repeat break point), press the **TAX SHIFT 1** key.
12. Press the **CASH** key to complete the tax program.

PLU Programming

All PLUs, whether they are registered by pressing a PLU key on the keyboard, or by entering the PLU number and pressing the **PLU** key, have the same programming options. These options are set through separate programs:

- “Program 100 - PLU Status Programming” determines whether the PLU is open, preset or inactive. Also selected here are tax, food stamp, scale, negative, single item, hash, gallonage, compulsory number entry, compulsory validation, compulsory condiment and print options.
- “Program 110 - PLU Auto Tare Programming” allows you to select up to three groups where each PLUs sales will accumulate.
- “Program 150 - PLU Group Assignment” allows you to select up to three groups where each PLUs sales will accumulate.
- “Program 200 - PLU Price/HALO Programming” determines the PLU price if the PLU is preset, or the high amount lock out (HALO) if the PLU is open.
- “Program 250 - PLU Stock Amount Programming” allows you to add stock to the PLU sales counters for PLUs you have designated as stock keeping PLUs.
- “Program 300 - PLU Descriptor Programming” allows you to set a unique descriptor, up to 18 characters, for each PLU.
- “Program 350 - PLU Link Programming” allows you to link a PLU to another PLU, so that registration of the first PLU will automatically trigger registration of the linked PLU.
- “Program 400 – PLU Delete Programming” allows you to delete a PLU.
- “Program 450 – PLU Mix and Match Programming” allows you to designate items eligible for mix and match discounts.

Program 100 - PLU Status Programming

1. Turn the control lock to the **P** position.
2. To begin the program, enter **1 0 0**, press the **SBTL** key.



3. Select the PLU or PLUs you wish to program in one of the following ways:

- Press a PLU key on the keyboard or scan the item.

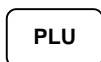

- If sequential PLUs are to receive the same status, press the first PLU key and then press the last PLU key.



- Enter the number of the PLU (up to 15 digits) and press the **PLU** key.



- Enter the number of the first PLU in a range of PLUs that are to receive the same setting; press the **PLU** key. Enter the last number in the range; press the **PLU** key.



4. Refer to the "PLU Status Chart" to determine the values for **N1** through **N9**. (If an address offers more than one option, add the values for each option and enter the sum. For example, if you wish the PLU to be taxable by rates 2 and 4, add the values for your choices, 1 + 4, and enter the sum "5" for address N2.) Enter the values you have selected, press the **X/TIME** key. (**You do not need to enter preceding zeros.** For example, if you are only selecting a value for **N9**, just enter that value.)



5. To program additional PLUs, repeat from step 3, or press the **CASH** key to finalize the program.



PLU Status Chart

Address	Program Option	Value	=	Sum
N1	PLU is preset?	Yes = 0 No = 1		
	PLU is override preset ?	Yes = 0 No = 2		
	PLU is taxable by rate 1?	Yes = 4 No = 0		
N2	PLU is taxable by rate 2?	Yes = 1 No = 0		
	PLU is taxable by rate 3?	Yes = 2 No = 0		
	PLU is taxable by rate 4?	Yes = 4 No = 0		
N3	PLU is food stamp eligible?	Yes = 1 No = 0		
	PLU is negative item?	Yes = 2 No = 0		
	PLU is hash?	Yes = 4 No = 0		
N4	PLU is single item?	Yes = 1 No = 0		
	Compulsory non-add number?	Yes = 2 No = 0		
	PLU is gallonage?	Yes = 4 No = 0		
N5	PLU is stock?	Yes = 1 No = 0		
	PLU is inactive?	Yes = 2 No = 0		
	PLU is scalable?	Yes = 4 No = 0		
N6	PLU is auto-scale entry?	Yes = 1 No = 0		
	PLU is a condiment?	Yes = 2 No = 0		
	Compulsory condiment entry?	Yes = 4 No = 0		
N7	Print PLU on receipt?	Yes = 0 No = 1		
	Print PLU on detail?	Yes = 0 No = 2		
	Print PLU on check?	Yes = 0 No = 4		
N8	Print item's price on receipt?	Yes = 0 No = 1		
	Print item's price on check?	Yes = 0 No = 2		
	PLU is disabled PROMO function?	Yes = 4 No = 0		
N9	PLU counter is not reset when a PLU Z report is done?	Yes = 1 No = 0		
	PLU is preset override in MGR control?	Yes = 2 No = 0		

PLU Options - Reference Information

Option	Description
PRESET OVERRIDE	If Yes , you can enter a price to override the preset price.
FOOD STAMP ELIGIBLE	Select Yes to accumulate a total of food stamp eligible items in the current sale. The total can be viewed by pressing the F/S SUB key and food stamps can be tendered with the F/S TEND key.
HASH	Items designated with HASH status add to the current sale, but do not add to the registers grand total. HASH items may or may not add to the net sales total - see system option programming. Use hash for lottery sales or bottle deposits.
SINGLE ITEM	Select Yes for a single item PLU. Single item PLUs automatically total as a cash sale immediately after the PLU entry. Single item PLUs are used to speed up one item sales.
NON-ADD # COMP	Select Yes to enforce the entry of a non-add number before a registration can be made.
GALLONAGE ITEM	Select Yes to compute gallons sold. The gallons sold will print along with the price entry on the receipt. The total gallons sold will accumulate in the PLU counter. You must program the price per gallon (in tenths of a cent, i.e. \$1.299 for \$1.29 and 9/10) in the PRICE/HALO field.
STOCK ITEM	Select Yes if you wish to track the number of items remaining in stock using the Stock report.
SCALEABLE	If Yes , the PLU will work only when you are multiplying a weight from an optional scale or when multiplying a manually entered weight. (For example, enter weight, press SCALE , then register PLU.)
AUTO SCALE	Select Yes if you wish entries into this PLU to be automatically multiplied by the weight on the optional scale.
CONDIMENT	Select Yes if you wish the item to act like a condiment on the kitchen printer. Items with this status will satisfy the requirements of items with compulsory condiment status.
COMPULSORY CONDMNT	Select Yes if you wish to force the entry of a condiment after this item is entered.
PRINT ON RECEIPT PRINT ON DETAIL PRINT ON CHECK	Select No if you wish to suppress printing of the item at the designated location.
PRT PRICE ON RCPT	Select No if you wish to suppress printing of the item's price on the receipt.
PRT PRICE ON CHK	Select No if you wish to suppress printing of the item's price on the check.
DISABLE PROMO	Select Yes to block the PROMO function on this PLU.
COUNTER NOT RESET	Select Yes if you do not wish to reset the PLU item counter on the Z PLU report.
PRESET OVERRIDE IN MGR CONTROL	If preset override is Yes , then you can force manager control for preset override.

Program 110 - PLU Auto Tare Programming

1. Turn the control lock to the **P** position.
2. To begin the program, enter **1 1 0**, press the **SBTL** key.

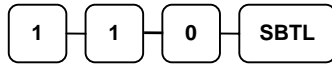

3. Select the PLU or PLUs you wish to program in one of the following ways:
 - Press a PLU key on the keyboard or scan the item.



- If sequential PLUs are to receive the same status, press the first PLU key and then press the last PLU key.



- Enter the number of the PLU (up to 15 digits) and press the **PLU** key.



- Enter the number of the first PLU in a range of PLUs that are to receive the same setting; press the **PLU** key. Enter the last number in the range; press the **PLU** key.



4. Enter a value (1-5) to indicate the number of the preprogrammed tare weight you want to automatically subtract when the PLU is used for scale entry (using an optional scale), and then press the **X/TIME** key. Enter 0 to disable automatic tare subtraction.

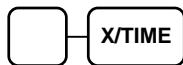

5. To program additional PLUs, repeat from step 3, or press the **CASH** key to finalize the program.

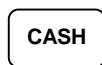

Program 150 - PLU Group Assignment

Each PLU may report to any three of 20 groups. Group totals appear on reports, so that you can track sales of different types of items. A group can also be used to designate items that are to print on an optional kitchen printer. The first of the three groups to which a PLU can be assigned determines kitchen printer routing.

Note: The PLU will report to group "1", if not programmed to report to another group.

1. Turn the control lock to the **P** position.
2. To begin the program, enter **1 5 0**, press the **SBTL** key.

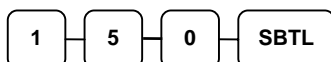

3. Select the PLU or PLUs you wish to program in one of the following ways:

- Press a PLU key on the keyboard or scan the item.

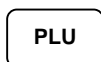

- If sequential PLUs are to receive the same status, press the first PLU key and then press the last PLU key.



- Enter the number of the PLU (up to 15 digits) and press the **PLU** key.



- Enter the number of the first PLU in a range of PLUs that are to receive the same setting; press the **PLU** key. Enter the last number in the range; press the **PLU** key.



4. Enter up to three 2-digit numbers representing the groups where you wish to add the PLUs sales, i.e. enter **1 0** for group 10 or enter **0 4** for group four. Press the **X/TIME** key.



1st Group 2nd Group 3rd Group

5. To program additional PLUs, repeat from step 3, or press the **CASH** key to finalize the program.



Program 200 - PLU Price/HALO Programming

If a PLU is open, set the HALO (high amount lock out) here. If a PLU is preset set the preset price here. If a PLU is set with gallonage status, enter the price per gallon here. (Enter price per gallon in tenths of a penny, i.e. 1299 for \$1.29 9/10 per gallon.)

1. Turn the control lock to the **P** position.
2. To begin the program, enter **2 0 0**, press the **SBTL** key.



3. Select the PLU or PLUs you wish to program in one of the following ways:

- Press a PLU key on the keyboard or scan the item.



- If sequential PLUs are to receive the same status, press the first PLU key and then press the last PLU key.



- Enter the number of the PLU (up to 15 digits) and press the **PLU** key.



- Enter the number of the first PLU in a range of PLUs that are to receive the same setting; press the **PLU** key. Enter the last number in the range; press the **PLU** key.



4. If the PLU is open, enter a HALO of up to 7 digits. If the PLU is preset, enter a preset price. (The maximum preset price you can enter is \$50,000.00.)



Price/HALO

5. To program additional PLUs, repeat from step 3, or press the **CASH** key to finalize the program.

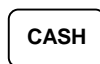

Program 250 - PLU Stock Amount Programming

With this program, you can add stock to the PLU sales counters for PLUs you have designated as stock PLUs. See "Program 100 - PLU Status Programming" to set option **N5** to set stock status. The stock number set here can be the amount of stock that is being added to the current level, or optionally, it can be the new total stock level. See option #18 in "System Option Programming" to set this option.

1. Turn the control lock to the **P** position.
2. To begin the program, enter **2 5 0**, press the **SBTL** key.

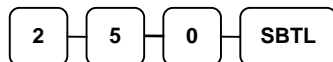

3. Select the PLU or PLUs you wish to program in one of the following ways:

- Press a PLU key on the keyboard or scan the item.

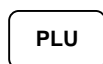

- If sequential PLUs are to receive the same status, press the first PLU key and then press the last PLU key.



- Enter the number of the PLU (up to 15 digits) and press the **PLU** key.



- Enter the number of the first PLU in a range of PLUs that are to receive the same setting; press the **PLU** key. Enter the last number in the range; press the **PLU** key.



4. Enter the stock amount you wish to add (up to six digits), press the **X/TIME** key.



Stock Amount

5. To program additional PLUs, repeat from step 3, or press the **CASH** key to finalize the program.

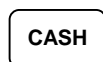

Program 300 - PLU Descriptor Programming

Program descriptors by typing descriptors on the alpha keyboard overlay or by entering three digit alpha character codes. To enter descriptors by three digit alpha character codes you must add a value of '1' to system option #25 (See "System Option Programming" on page 112).

Note: You can program descriptors up to 18 characters, however only the first 16 will appear on the display.

1. Turn the control lock to the **P** position
2. To begin the program, enter **3 0 0**, press the **SBTL** key.



3. Select the PLU you wish to program in one of the following ways:

- Press a PLU key on the keyboard or scan the item.

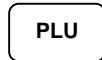

- Enter the number of the PLU (up to 15 digits) and press the **PLU** key.



4. If you are programming using an alpha keyboard overlay, type up to 18 descriptors on the overlay and press the **X/TIME** key.

Type up to 18
descriptor keys → 

If you are programming using descriptor codes, enter up to 18 three-character codes and press the **X/TIME** key. (See "Descriptor Code Chart" on page 108.)

Enter up to 18 three-
character codes → 

5. To program additional PLUs, repeat from step 3, or press the **CASH** key to finalize the program.

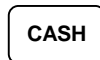

ER-5200M Alpha Keyboard Overlay

!	@	#	\$	%	^	&	*	()	-	+				
Q	W	E	R	T	Y	U	I	O	P	<	>				
A	S	D	F	G	H	J	K	L	;	'	?	CLEAR			
Z	X	C	V	B	N	M	,	.	/	:	=	7	8	9	
CAPS	DOUBLE	SPACE	SPACE	SPACE	SPACE	SPACE	CAPS	DOUBLE	BACK	SPACE	"		4	5	6
												1	2	3	
												0	00	.	

ER-5240M Alpha Keyboard Overlay

RECT FEED	DETL FEED	RCPT ON/OFF	#/NS	TAX 1	!	@	#	\$	%	^	&	*	()
ERROR CORR	P L U	CLEAR	X/TIME	Q	W	E	R	T	Y	U	I	O	P	
VOID		7	8	9	A	S	D	F	G	H	J	K	L	
CANCEL	RETURN	4	5	6	Z	X	C	V	B	B	N	M	CHECK	
% 1	% 3	1	2	3	-	+	<	>		?	:	=	SBTL	
% 2	% 4	0	00	.	CAPS	DBL	SPACE	DBL	B- SPACE	-	.	/	CASH	

Descriptor Code Chart

CHAR	Ç	ü	é	â	ä	à	å	ç	ê	ë
CODE	001	002	003	004	005	006	007	008	009	010
CHAR	è	ï	î	ì	Ä	Å	É	æ	Æ	ô
CODE	011	012	013	014	015	016	017	018	019	020
CHAR	ö	ò	û	ù	ÿ	ö	Ü	ç	£	¥
CODE	021	022	023	024	025	026	027	028	029	030
CHAR	€	SPACE	!	"	#	\$	%	&	'	(
CODE	031	032	033	034	035	036	037	038	039	040
CHAR)	*	+	,	-	.	/	0	1	2
CODE	041	042	043	044	045	046	047	048	049	050
CHAR	3	4	5	6	7	8	9	:	;	<
CODE	051	052	053	054	055	056	057	058	059	060
CHAR	=	>	?	@	A	B	C	D	E	F
CODE	061	062	063	064	065	066	067	068	069	070
CHAR	G	H	I	J	K	L	M	N	O	P
CODE	071	072	073	074	075	076	077	078	079	080
CHAR	Q	R	S	T	U	V	W	X	Y	Z
CODE	081	082	083	084	085	086	087	088	089	090
CHAR							a	b	c	d
CODE	091	092	093	094	095	096	097	098	099	100
CHAR	e	f	g	h	i	j	k	l	m	n
CODE	101	102	103	104	105	106	107	108	109	110
CHAR	o	p	q	r	s	t	u	v	w	x
CODE	111	112	113	114	115	116	117	118	119	120
CHAR	y	z	BACK SPACE			Double				
CODE	121	122	123			999				

Program 350 - PLU Link Programming

PLU link programming allows you to link a PLU to another PLU, so that registration of the first PLU will automatically trigger registration of the linked PLU. For example, you may wish to link a bottle deposit with the sale of beverages, or you may wish to register a group of items normally sold together.

1. Turn the control lock to the **P** position.
2. To begin the program, enter **3 5 0**, press the **SBTL** key.

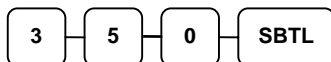

3. Select the PLU you wish to program in one of the following ways:

- Press a PLU key on the keyboard or scan the item.

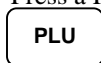

- Enter the number of the PLU (up to 15 digits) and press the **PLU** key.



4. Enter the number of the PLU you wish the PLU linked to; press the PLU key. Or press the PLU key on the keyboard you wish the PLU linked to.



If you want to unlink



5. To program additional PLUs, repeat from step 3, or press the **CASH** key to finalize the program.

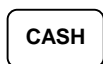

Program 400 – PLU Delete Programming

NOTE: To delete a PLU, all totals for the PLU must be cleared from Z reports (including Stock and PLU reports.)

1. Turn the control lock to the **P** position.
2. To begin the program, enter **4 0 0**, press the **SBTL** key.



3. Select the PLU or PLUs you wish to program in one of the following ways:
 - Press a PLU key on the keyboard or scan the item.

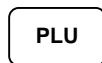

- Press the first PLU key that is to be deleted and press the last PLU key.



- Enter the number of the PLU you wish to delete and press the **PLU** key.



- Enter the number of the first PLU in a range you wish to delete and press the **PLU** key. Enter the last number in the range; press the **PLU** key.



4. Press **X/TIME** key.

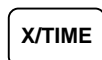

5. To program additional PLUs, repeat from step 3, or press the **CASH** key to finalize the program.

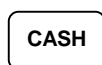

Program 450 – PLU Mix and Match Programming

If a PLU is eligible for a mix and match discount, enter the mix and match table for the PLU here. See “Mix and Match Discount Programming” on page 148 for more information.

1. Turn the control lock to the **P** position.
2. To begin the program, enter **4 5 0**, press the **SBTL** key.



3. Select the PLU or PLUs you wish to program in one of the following ways:

- Press a PLU key on the keyboard or scan the item.

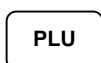

- Enter the number of the PLU (up to 15 digits) you wish to program and press the PLU key.



4. Enter the number of the Mix & Match Table (1-20) and press the **X/TIME** key.



5. To program additional PLUs repeat from step 3, or press the **CASH** key to finalize the program.



System Option Programming

Refer to the “System Option Table” to review the system options. Read each option carefully to determine if you wish to make any changes.

NOTE: Because after clearing memory all options settings are automatically set to 0, and because your most likely option selections require a status setting of 0, you do not need to program this section unless you wish to change the default status.

Programming a System Option

1. Turn the control lock to the **P** position.
2. Enter **3 0**, press the **SBTL** key.
3. Enter a system option address and press the **X/TIME** key.
4. Enter the number representing the status you have selected, or if there is more than one decision to be made in an address, add the values representing your choices for each decision and enter the sum. Press the **SBTL** key.
5. Repeat from step 3 for each system option you wish to change.
6. Press the **CASH** key to end system option programming.

System Option Flowchart

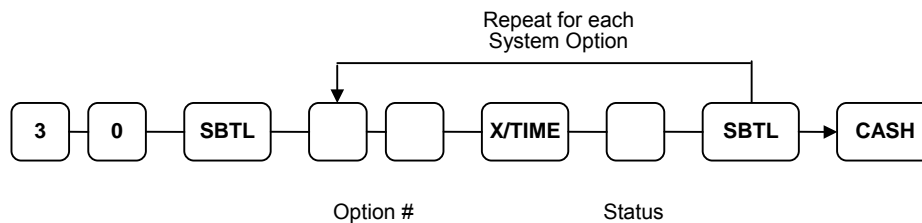

System Option Table

Address	SYSTEM OPTION	VALUE	=	SUM
1	Beeper is active?	Yes = 0 No = 1		
	Clerk operation is real clerk key?	Yes = 2 No = 0		
2	Clerk sign on method is:	Direct entry =	0	
		Code entry =	1	
3	Clerks are:	Pop-up =	1	
		Stay down =	0	
4	Enforce closed drawer for register operation?	Yes = 0 No = 1		
	Open drawer alarm is active?	Yes = 2 No = 0		
5	The number of seconds before the open drawer warning tone sounds (default is 30 seconds).	1-99		
6	Allow the post tender function?	Yes = 1 No = 0		
	Drawer is opened on post tender?	Yes = 0 No = 2		
	Allow multiple receipts?	Yes = 4 No = 0		
7	Cash declaration is compulsory before reports may be taken?	Yes = 1 No = 0		
	Allow negative balance sales in the X control lock position only?	Yes = 2 No = 0		
8	Allow zero balance sales in the X control lock position only?	Yes = 1 No = 0		
	Consecutive number is reset after a financial report?	Yes = 2 No = 0		
9	Grand total is reset after a Z Financial report?	Yes = 1 No = 0		
	Cash drawer will open when reports are run?	Yes = 0 No = 2		
	Open drawer during training mode?	Yes = 0 No = 4		
10	Decimal place: (0,1,2,3) default=2	0-3		
11	Date format is:	MMDDYY =	0(default)	
		DDMMYY =	1	
		YYMMDD =	2	

Address	SYSTEM OPTION	VALUE	=	SUM	
12	Percentage and Tax calculations will:	Round up at 0.005 =	0(default)		
		Always round up =	1		
		Always round down =	2		
13	Split price calculations will:	Round up at 0.005 =	0(default)		
		Always round up =	1		
		Always round down =	2		
14	Eat-in/Take-out/Drive Thru procedure compulsory before tendering is allowed?		Yes = 1 No = 0		
	Hash is	Normal =	0		
		Non-add =	2		
15	Reset the Financial report Z counter after a Z1 Financial report?		Yes = 1 No = 0		
	Reset the Time report Z counter after a Z1 Time report?		Yes = 2 No = 0		
	Reset the PLU report Z counter after a Z1 PLU report?		Yes = 4 No = 0		
16	Reset the Clerk report Z counter after a Z1 Clerk report?		Yes = 1 No = 0		
	Reset the Group report Z counter after a Z1 Group report?		Yes = 2 No = 0		
17	Reset the Daily sales report Z counter after a Z2 Daily sales report?		Yes = 1 No = 0		
	Paper sensor is enabled?		Yes = 0 No = 2		
	Split pricing is deactivated?		Yes = 4 No = 0		
18	Enable direct multiplication?		Yes = 1 No = 0		
	Stock counter programming:	Adds to current level =	2		
		Replaces current level =	0		
19	The number of numeric digits: 0 is no limit		0-14		
20	Allow multiplication by more than one digit?		Yes = 1 No = 0		
	Tender Validation amount is:	Amount tendered =	2		
		Amount of sale =	0		

Address	SYSTEM OPTION	VALUE	=	SUM
21	Display "add" price of linked item?	Yes = 1 No = 0		
	Allow sale when stock reaches "0"?	Yes = 0 No = 2		
	Allow Swedish round on subtotal?	Yes = 4 No = 0		
22	Allow Swedish round on cash?	Yes = 1 No = 0		
	Allow Z stock report?	Yes = 0 No = 2		
23	Training mode	Enter =	1	
		Exit =	0	
24	Auto Cutter?	Yes = 1 No = 0		
25	Program descriptors with Overlay?	Yes = 0 No = 1		
	NOT USED			
	Disable Cash Declaration?	Yes = 4 No = 0		
26	Table Management =		0	
	Clerk Interrupt =		1	
27	Modifier is:	Pop-up after item =	0	
		Pop-up after sale =	1	
		Stay-down =	2	
28	Require manager to open/close checks?	Yes = 1 No = 0		
	Enable charge posting functions?	Yes = 2 No = 0		
29	Receipt Buffer: A maximum of 200 lines may be entered per transaction	=	0	
	Entry of more than 200 Lines is allowed, however a buffered receipt is not itemized	=	1	
	Normal EFT Draft = Add tip line to EFT Draft =		0 2	
30	Price embedded barcode type:			
	Disabled =		0	
	Type 1 =		1	
	Type 2 =		3	
	Type 4 =		4	
		Type 7 =	7	
31	Pin Pad Type:			
	DUKPT = ROTATE =		0 1	
32	Send Reports to Remote printer (Use version 5.5 software or later)	Yes = 1 No = 0		

System Options - Reference Information

#	Option	Description
1	Clerk Operation is real clerk key	Select Y if the optional bayonet clerk lock and key system is installed.
2	Clerk sign on method is Direct Entry or Code Entry	For direct entry, enter the clerk code and press the CLERK key. For code entry, press the CLERK key, enter the clerk code and press the CLERK key.
6	Allow the post tender function	Select Y to allow re-tendering should a second change calculation become necessary. Re-enter the tendered amount and press the CASH key to show the new change computation.
14	Hash is NORMAL or NON-ADD	Normal Hash adds to all totals except the gross and net sales totals on the financial report. Non-add Hash does not add to any totals, except the HASH total on the financial report.
17	Split Pricing is deactivated?	If N , both multiplication and split pricing calculations can be done with the @/FOR key. If Y , only multiplication can be done with the @/FOR key.
18	Enable Direct Multiplication	If Y , you can multiply preset items by simply entering the quantity, then pressing the preset PLU key.
21	Display add price of linked item?	When Y , the customer display shows a total of the item and linked item. For example, if PLU is \$1.00 and is linked to PLU2, which is \$0.25, the display will show \$1.25.
21 22	Allow swedish round on subtotal? Allow swedish round on cash?	Swedish rounding rounds as below: .00 - .02 = .00 .03 - .07 = .05 .08 - .09 = .10

#	Option	Description
26	Table Management, or Clerk Interrupt	<p>Clerk Interrupt allows you to temporarily suspend an incomplete transaction by signing on a new clerk. The new clerk can begin a new transaction with the first transaction temporarily suspended. The original transaction can be recalled for completion by signing on the original clerk. You cannot use check/table tracking or charge posting when the clerk interrupt system is implemented.</p> <p>Using the clerk interrupt feature requires allocation of at least 2 guest checks and sufficient soft check lines to support the interrupted transaction (i.e. if 20 soft check lines are allocated, a transaction with up to 20 lines can be interrupted.)</p>
27	Modifier is: Pop-up after item? Pop-up after sale? Stay-down?	<p>A MODIFIER key alters the next PLU registered, either by changing the code number of the PLU so that a different item is registered, or by adding the modifier descriptor and not changing the code of the subsequent PLU. If you press a modifier key, you have the option of the modifier applying only to the next item (0), having the same modifier apply to any subsequent item registered in the same transaction (1), or having the same modifier apply to any subsequent item on any subsequent transaction (2).</p>
28	Require manager to open/close checks? Enable charge posting functions?	<p>When Y, you must turn the key lock to the MGR position if you wish to open a new check or close a check. This option will usually be Y when a charge posting system is implemented and you do not wish a clerk to inadvertently open a new account.</p> <p>When charge posting is enabled, the FINALIZE, PAYMENT, and PAY TENDER keys are enabled.</p>
29	Buffer memory use Normal Use More than 100 lines	<p>If set to "normal use" transactions are limited to 100 items. If set to "more than 100 items" transactions can exceed 100 items, however, the receipt will not print items, only the total.</p>

Print Option Programming

Refer to the “Print Option Table” to review the print options. Read each option carefully to determine if you wish to make any changes.

NOTE: Because after clearing memory all options settings are automatically set to 0, and because your most likely option selections require a status setting of 0, you do not need to program this section unless you wish to change the default status.

Programming a Print Option

1. Turn the control lock to the **P** position.
2. Enter **4 0**, press the **SBTL** key.
3. Enter a print option address and press the **X/TIME** key.
4. Enter the number representing the status you have selected, or if there is more than one decision to be made in an address, add the values representing your choices for each decision and enter the sum. Press the **SBTL** key.
5. Repeat from step 3 for each print option you wish to change.
6. Press the **CASH** key to end print option programming.

Print Option Flowchart

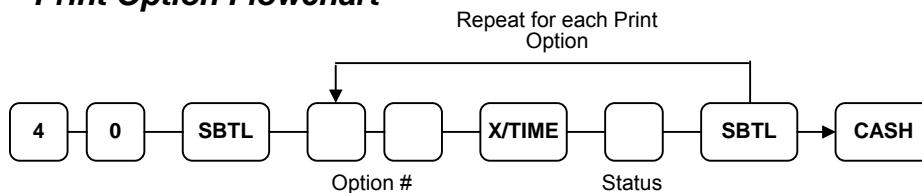

Print Option Table

Address	PRINT OPTION	VALUE	=	SUM
1	Print media total on clerk report?	Yes = 1 No = 0		
	Print tax symbol?	Yes = 0 No = 2		
2	Void/Return totals will print on the Financial report?	Yes = 0 No = 1		
	Audaction total will print on the Financial report?	Yes = 2 No = 0		
3	Skip media totals with zero activity on the Financial report?	Yes = 0 No = 1		
	Skip media totals with zero activity on the Clerk report?	Yes = 0 No = 2		
	Print Clerk report at the end of the Financial report?	Yes = 4 No = 0		
4	Print PLU sale item number?	Yes = 1 No = 0		
	Print PLU with zero totals on report?	Yes = 2 No = 0		
	Subtotal is printed when the SBTL key is pressed?	Yes = 4 No = 0		
5	Print percentage of sales on the PLU report?	Yes = 1 No = 0		
	Print consecutive number counter on receipt?	Yes = 0 No = 2		
6	Print date on receipt?	Yes = 0 No = 1		
	Print time on receipt?	Yes = 0 No = 2		
	Print machine number on receipt?	Yes = 0 No = 4		
7	Print clerk name on receipt?	Yes = 0 No = 1		
	Print Z counter on reports?	Yes = 0 No = 2		
8	Home Currency symbol	\$(Default)		
9	Print receipt when sign on/off?	Yes = 0 No = 1		
	Print Grand total on the X Financial report?	Yes = 0 No = 2		
	Print Grand total on the Z Financial report?	Yes = 0 No = 4		

Address	PRINT OPTION	VALUE	=	SUM
10	Print Gross total on the X Financial report?	Yes = 0 No = 1		
	Print Gross total on the Z Financial report?	Yes = 0 No = 2		
11	Print the subtotal without tax on the receipt?	Yes = 1 No = 0		
	Tax amount to print on receipt is:	Combine =	2	
		Itemize =	0	
12	Print the tax amount on receipt?	Yes = 0 No = 1		
	Print taxable totals?	Yes = 2 No = 0		
	Print the tax rate?	Yes = 4 No = 0		
13	Print a breakdown of the VAT eligible sale?	Yes = 1 No = 0		
	Print training mode message on the receipt during training mode operations?	Yes = 2 No = 0		
14	Currency Symbol:	CONV. #1 =	.	
15		CONV. #2 =	.	
16		CONV. #3 =	.	
17		CONV. #4 =	.	
18	Print the order number on the kitchen printer requisition?	Yes = 0 No = 1		
	Print the item's price on the kitchen printer requisition?	Yes = 2 No = 0		
19	Print registrations in void mode on the kitchen printer requisition?	Yes = 0 No = 1		
	Print registrations in training mode on the kitchen printer requisition?	Yes = 2 No = 0		
20	Combine like items on the kitchen printer?	Yes = 0 No = 1		
	Consolidation of like items on check track?	Yes = 0 No = 2		
	Chooses volume unit when the PLU is gallonage.	Gallons =	0	
Liters =		4		

21	Print preamble message on receipt?		Yes = 0 No = 1		
	Print postamble message on receipt?		Yes = 0 No = 2		
	Print preamble message on the guest check?		Yes = 4 No = 0		
22	Print postamble message on the guest check?		Yes = 1 No = 0		
	Do not print pre/postamble message on the journal receipt?		Yes = 0 No = 2		
23	Print average items per customer on the Financial report?		Yes = 0 No = 1		
	Print average sales per customer on the Financial report?		Yes = 0 No = 2		
24	Allow a second receipt for the same transaction?		Yes = 1 No = 0		
	Priority print by group on the kitchen printer?		Yes = 2 No = 0		
	Print the PLU number and descriptor on the receipt?		Yes = 4 No = 0		
25	Print when polling reports?		Yes = 1 No = 0		
	Print PLU# on PLU report?		Yes = 2 No = 0		
	Grand total is:	Net sale =	4		
		Gross sale =	0		
26	Print journal font	Small =	0		
		Normal =	1		
	Print negative journal items in reverse print?		Yes = 2 No = 0		
	Journal print is off?		Yes = 4 No = 0		
27	Send order to the kitchen printer when the SBTL key is pressed?		Yes = 1 No = 0		
	Print date on hard check?		Yes = 2 No = 0		
28	Print pre graphic logo on receipt?		Yes = 1 No = 0		
	Print post graphic logo on receipt?		Yes = 2 No = 0		

29	Print pre graphic logo on guest check?		Yes = 1 No = 0		
	Print post-graphic logo on guest check?		Yes = 2 No = 0		
30	Pre graphic logo	Default =	0		
		User =	1		
	Post graphic logo	Default =	0		
		User =	2		
Print tax only for last serviced items?		Yes = 0 No = 4			
31	Number of pre-feeding lines on receipt.		0-5		
32	Number of post-feeding lines on receipt.		0-5		
33	Print open check totals on financial report.		Yes = 0 No = 1		
	Print PLU report before financial report.		Yes = 2 No = 0		
34	Number of DataTran Receipt Copies:		0-99		
35	Mask credit card number on all EFT drafts?.		Yes = 0 No = 1		
	Print expiration date?		Yes = 0 No = 2		

Print Options - Reference Information

#	Option	Description
1	Print media totals on clerk report	Select Yes to print media totals for each clerk, thus allowing clerk cash drawer accountability.
	Print tax symbol	Select No to remove the tax symbol (i.e. "T1") from the print and display.
4	Print PLU sale item number?	If Yes , each receipt will print the total number of PLU items sold in the transaction.
5	Print % of sales on PLU report?	The register can calculate the percentage of sales represented by each PLU. Select Yes if you wish to print this percentage on the PLU report.
8	Home currency symbol	Users outside of the USA can designate a different currency symbol. To select a different symbol, type descriptors on the alpha keyboard overlay or enter three digit alpha character codes. To enter a descriptor by three digit alpha character codes you must select No in system option #25 (See "System Option Programming" on page 54).

#	Option	Description
9	Print receipt when sign on/off?	Select No if you do not wish to print a receipt when signing on or off a clerk.
11	Print subtotal without tax on the receipt?	If you hand-write credit card slips, you may find it useful to print the merchandise subtotal. Select Yes if you wish to print the subtotal without tax on the receipt.
	Tax amount on receipt is: Combine or Itemize	Select Yes if you are calculating and reporting more than one sales tax rate separately and you wish to print just the total of multiple taxes rather than itemize each tax on the receipt.
13	Print a breakdown of the VAT eligible sale?	If Yes , a breakdown of the VAT eligible sale will print the net amount and the VAT amount.
14 15 16 17	Currency symbol: conv.#1 conv.#2 conv.#3 conv.#4	If you are using the currency conversion feature, you can select the appropriate symbol for each foreign currency you are accepting. To select a different symbol, type descriptors on the alpha keyboard overlay or enter three digit alpha character codes. To enter a descriptor by three digit alpha character codes you must select No in system option #25 (See "System Option Programming" on page 54).
20	Combine like items on the kitchen printer?	If two of the same items are registered in the same transaction, you can choose the format on the kitchen requisition. For example, if Yes , "2 HAMBURGERS; if N, "1 HAMBURGER" and "1 HAMBURGER".
	Combine like items on check track?	Consolidation of like items can be selected for soft guest check printing. For example, if three rounds of drinks are served, the check will print "3 TAP BEER" rather than "1 TAP BEER" three times.
23	Print average items per customer on the Financial report? Print average sales per customer on the Financial report?	Choose whether to print the average items per customer (PLU sales counter/Net sales counter) or the average sales per customer (Net Sales/Net Sales counter).
24	Priority print by group on the kitchen printer?	If Yes , the order in which items appear on a kitchen requisition is determined by the group to which the item is assigned, i.e. items reported to group 1 will print before items reported to group 2.
30	Print tax only for last serviced items?	If Yes , tax is printed only for the last items posted (use for charge posting applications). If No , a summary of tax for all items posted on the check is printed (use for restaurant guest check posting).

Function Key Programming

Three programs are used to program function keys:

- *Program 70* - is used to set individual options for each function key
- *Program 80* - is used to program a 12-character alphanumeric descriptor. In the case of the **#/No Sale** key, provision is made to program a separate descriptor for the # and No Sale functions.
- *Program 90* - is used to set a high amount limit (HALO). In the case of percentage keys (%1-%5) the percentage rate or amount is programmed; In the case of currency conversion keys, the conversion rate is programmed.

In this chapter you will find:

- General instructions for programs 70, 80 and 90.
- Specific Program 70 option programming instructions for each function key.

Program 70 - Function Key Options

Use Program 70 to set options for function keys. Because of the differences inherent in function keys, individual options will be different. See the specific instructions for each key in this chapter to find the options for each key.

1. Turn the control lock to the **P** position.
2. To begin the program, enter **7 0**, press the **SBTL** key.

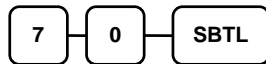

3. Enter the values for the option digit or digits. Depending on the function key you are programming, you may enter up to six digits **N1** through **N6**. Determine the values for **N1** through **N6** by referring to the specific function key information that follows. (**You do not need to enter preceding zeros**. For example, if the function key offers six digits, **N1** through **N6** and you are only selecting a value for **N6**, just enter the value for **N6**.) Press the function key you wish to program.

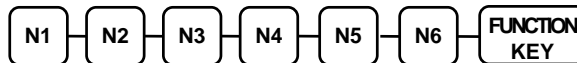

4. To program additional function keys, repeat from step 3, or press the **CASH** key to finalize the program.

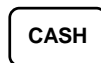

Program 80 - Function Key Descriptor

Program descriptors by typing descriptors on the alpha keyboard overlay or by entering three digit alpha character codes. To enter descriptors by three digit alpha character codes you must add a value of '1' to system option #25 (See "System Option Programming" on page 112).

Note: You can program descriptors up to 18 characters, however only the first 10 will appear on the display.

1. Turn the control lock to the **P** position.
2. To begin the program, enter **8 0**, press the **SBTL** key.

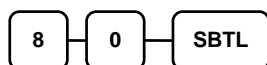

3. If you are programming using an alpha keyboard overlay, type up to 18 descriptors on the overlay and press the function key you are programming.



If you are programming using descriptor codes, enter up to 18 three-character codes and press the function key you are programming key. (See "Descriptor Code Chart" on page 108.)



4. To program additional function keys, repeat from step 3, or press the **CASH** key to finalize the program.



Descriptor Programs for the #/No Sale Key - Programs 80 & 81

Since two distinct functions, # entry and no sale, reside on the same key, different programs are used to program each descriptor.

To program the no sale descriptor:

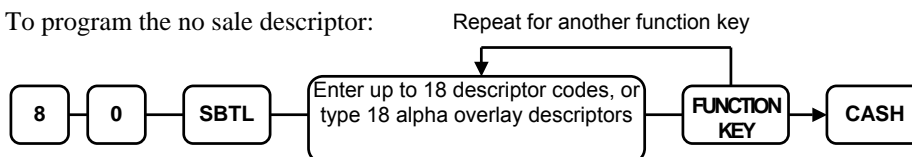

To program the # descriptor:

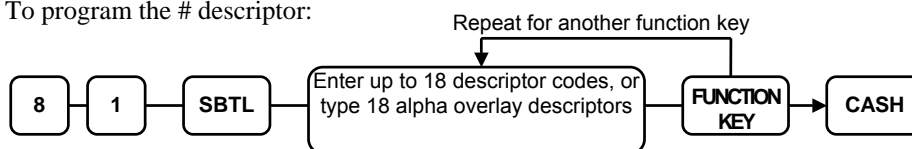

Program 90 - Function Key HALO

Use Program 90 to program a high amount lock out (HALO) for a function key. Only specific keys require this program. For example, you can set a HALO for the **CASH**, **CHECK** or **CHARGE** keys. Refer to the specific function key programming information in this chapter to determine when the HALO option is available.

Note: An 8 digit HALO has a maximum entry of \$500,000.00.

1. Turn the control lock to the **P** position.
2. To begin the program, enter **9 0**, press the **SBTL** key.

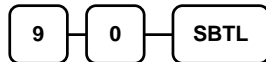

3. Enter a HALO of up to eight digits, (or "0" for no HALO). Press the function key on the keyboard you wish to program.



4. To program additional function keys, repeat from step 2, or press the **CASH** key to finalize the program.

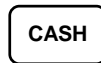

Program 90 Instructions for %1-%5 Keys

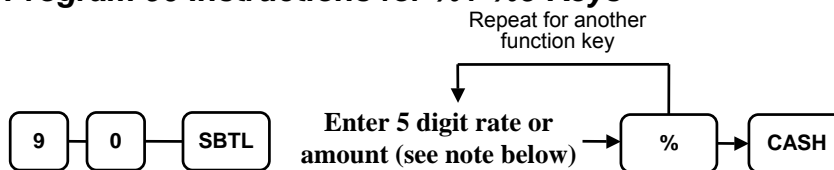

Note: If key is amount, enter 5 digit HALO, or 0 for no HALO. If key is percentage enter the percentage in a five-digit format, without the decimal (XX.XXX). For example: for 10%, enter 10000; for 5.55%, enter 05550; for 99.999%, enter 99999.

Instructions for Currency Conversion Rate - Program 90

1. Turn the control lock to the **P** position.
2. To begin the program, enter **9 0**, press the **SBTL** key.

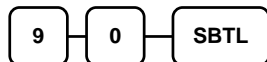

3. Enter the exchange rate of up to 7 digits (do not enter the decimal point), and then enter a number from 0 to 7 to indicate the decimal position. See "Currency Exchange Rate Programming Examples" below.

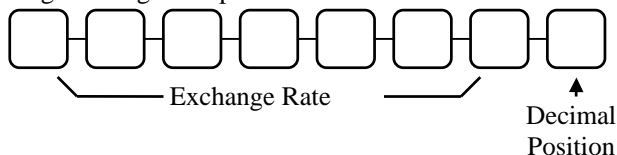

4. Press the function key on the keyboard you wish to program.



5. To program additional function keys, repeat from step 2, or press the **CASH** key to finalize the program.

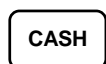

Currency Exchange Rate Programming Examples

Note: Foreign currency exchange rates may be stated as "foreign currency in dollars", or "dollars in foreign currency". Use the rate stated in "dollars in foreign currency" when you are programming this section.

The US dollar (home currency) is worth 1.3720 Canadian dollars (foreign currency).

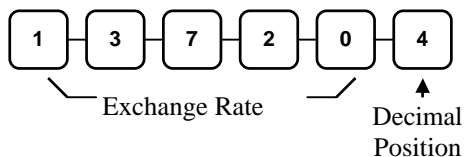

The US dollar (home currency) is worth 110.24 Japanese Yen (foreign currency).

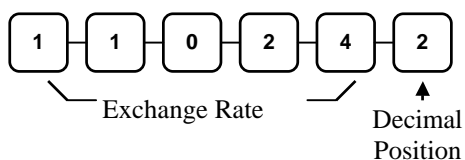

ADD CHECK - Function Key Options

Options - Program 70 (P-Mode)

Repeat for another function

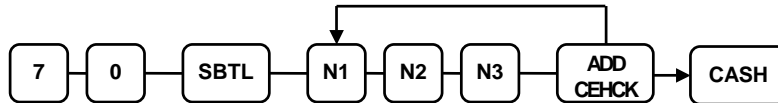

Address	OPTION	VALUE	=	SUM
N1	Key is inactive?	Yes = 1 No = 0		
	Compulsory before tendering?	Yes = 2 No = 0		
	Advance the consecutive # when this function is used?	Yes = 0 No = 4		
N2	Delete the pre/postamble when this function is used?	Yes = 0 No = 1		
	Exempt tax 1?	Yes = 2 No = 0		
	Exempt tax 2?	Yes = 4 No = 0		
N3	Exempt tax 3?	Yes = 1 No = 0		
	Exempt tax 4?	Yes = 2 No = 0		
	Validation is compulsory?	Yes = 4 No = 0		

CANCEL - Function Key Options

Options - Program 70 (P-Mode)

Repeat for another function

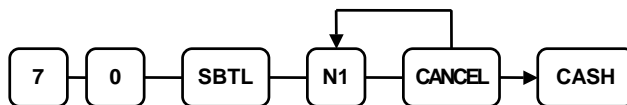

Address	OPTION	VALUE	=	SUM
N1	Key is inactive?	Yes = 1 No = 0		
	Key is active in X control lock position only?	Yes = 2 No = 0		

CASH - Function Key Options

Options - Program 70 (P-Mode)

Repeat for another function

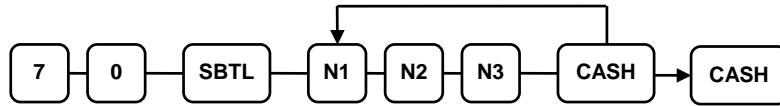

Address	OPTION	VALUE	=	SUM
N1	Amount tender is compulsory?	Yes = 1 No = 0		
	Allow over tendering and under tendering in X control lock position only?	Yes = 2 No = 0		
	Disable under tendering?	Yes = 4 No = 0		
N2	Open cash drawer?	Yes = 0 No = 1		
	Exempt tax 1?	Yes = 2 No = 0		
	Exempt tax 2?	Yes = 4 No = 0		
N3	Exempt tax 3?	Yes = 1 No = 0		
	Exempt tax 4?	Yes = 2 No = 0		
	Validation is compulsory?	Yes = 4 No = 0		

CHARGE 1-8 - Function Key Options

Repeat for another function

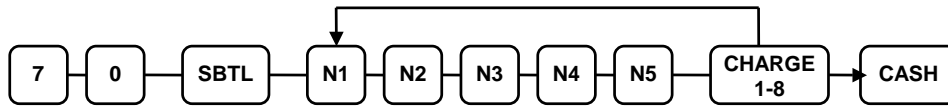

Address	OPTION	VALUE	=	SUM
N1	Amount tender is compulsory?	Yes = 1 No = 0		
	Allow over tendering and under tendering in X control lock position only?	Yes = 2 No = 0		
	Disable under tendering?	Yes = 4 No = 0		
N2	Open cash drawer?	Yes = 0 No = 1		
	Allow over tendering?	Yes = 2 No = 0		
	Non-add # entry compulsory?	Yes = 4 No = 0		
N3	Exempt tax 1?	Yes = 1 No = 0		
	Exempt tax 2?	Yes = 2 No = 0		
	Exempt tax 3?	Yes = 4 No = 0		
N4	Exempt tax 4?	Yes = 1 No = 0		
	Validation compulsory?	Yes = 2 No = 0		
	Connect DataTran?	Yes = 4 No = 0		
N5	Select Tramsaction Type: (for DataTran Operations)	Credit = 1 Debit = 2 Gift = 3		

CHECK - Function Key Options

Options - Program 70 (P-Mode)

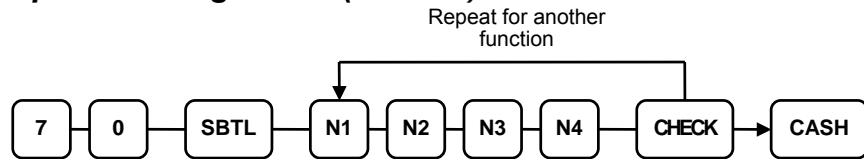

Address	OPTION	VALUE	=	SUM
N1	Amount tender is compulsory?	Yes = 1 No = 0		
	Allow over tendering and under tendering in X control lock position only?	Yes = 2 No = 0		
	Disable under tendering?	Yes = 4 No = 0		
N2	Open cash drawer?	Yes = 0 No = 1		
	Exempt tax 1?	Yes = 2 No = 0		
	Exempt tax 2?	Yes = 4 No = 0		
N3	Exempt tax 3?	Yes = 1 No = 0		
	Exempt tax 4?	Yes = 2 No = 0		
N4	Check endorsement compulsory?	Yes = 1 No = 0		
	Validation is compulsory?	Yes = 2 No = 0		

CHECK CASHING - Function Key Options

Options - Program 70 (P-Mode)

Repeat for another function

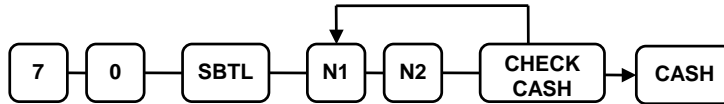

Address	OPTION	VALUE	=	SUM
N1	Key is inactive?	Yes = 1 No = 0		
	Key is active in X control lock position only?	Yes = 2 No = 0		
	Validation is compulsory?	Yes = 4 No = 0		
N2	Check Endorsement is compulsory? (Requires software version 5.2 or later.)	Yes = 1 No = 0		

CHECK ENDORSEMENT - Function Key Options

Options - Program 70 (P-Mode)

Repeat for another function

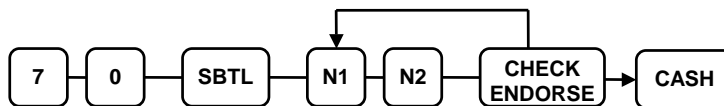

Address	OPTION	VALUE	=	SUM
N1	Key is inactive?	Yes = 1 No = 0		
	Print the amount of the check and endorsement message?	Yes = 2 No = 0		
	Print date?	Yes = 4 No = 0		
N2	Print time?	Yes = 1 No = 0		
	Print clerk?	Yes = 2 No = 0		
	Print consecutive number?	Yes = 4 No = 0		

CHECK # - Function Key Options

Options - Program 70 (P-Mode)

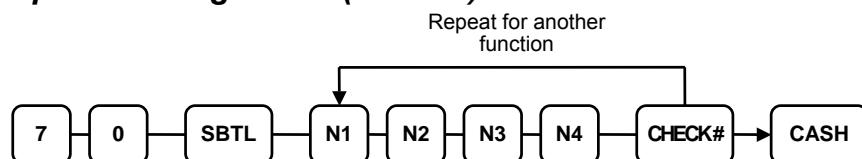

Address	OPTION	VALUE	=	SUM
N1	Key is inactive?	Yes = 1 No = 0		
	Before registering, begin a tracking number?	Yes = 2 No = 0		
	Opening clerk has exclusive access?	Yes = 4 No = 0		
N2	Check track # and balance will print on receipt?	Yes = 0 No = 1		
	Check track # and balance will print on remote?	Yes = 0 No = 2		
	Allow only one check per table?	Yes = 4 No = 0		
N3	Check# is automatically assigned by register?	Yes = 1 No = 0		
	PBAL key is used Drive thru recall key?	Yes = 2 No = 0		
N4	Length of Check (0-9)	0-9		

DRIVE THRU / EAT IN / TAKE OUT - Function Key Options

Options - Program 70 (P-Mode)

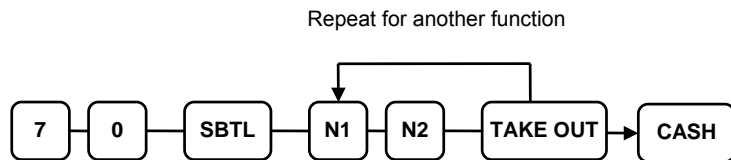
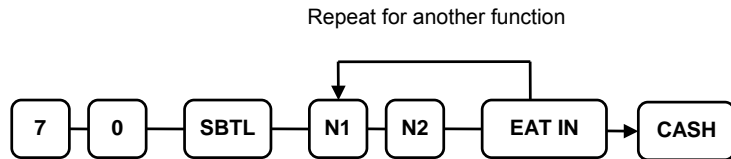
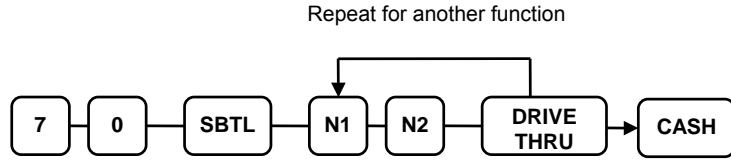

Address	OPTION	VALUE	=	SUM
N1	Exempt tax 1?	Yes = 1 No = 0		
	Exempt tax 2?	Yes = 2 No = 0		
	Exempt tax 3?	Yes = 4 No = 0		
N2	Exempt tax 4?	Yes = 1 No = 0		
	Validation is compulsory?	Yes = 2 No = 0		

ERROR CORRECT - Function Key Options

Options - Program 70 (P-Mode)

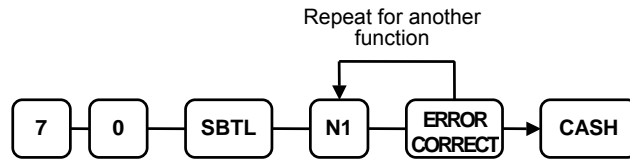

Address	OPTION	VALUE	=	SUM
N1	Key is inactive?	Yes = 1 No = 0		
	Key is active in X control lock position only?	Yes = 2 No = 0		
	Validation is compulsory?	Yes = 4 No = 0		

F/S Subtotal - Function Key Options

Options - Program 70 (P-Mode)

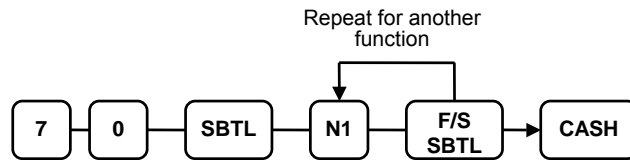

Address	OPTION	VALUE	=	SUM
N1	Key is inactive?	Yes = 1 No = 0		

F/S TEND - Function Key Options

Options - Program 70 (P-Mode)

Repeat for another function

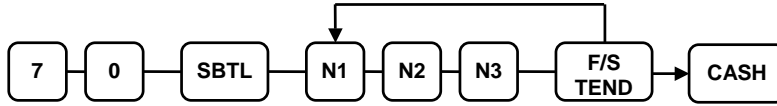

Address	OPTION	VALUE	=	SUM
N1	Exempt tax 1?	Yes = 1 No = 0		
	Exempt tax 2?	Yes = 2 No = 0		
	Exempt tax 3?	Yes = 4 No = 0		
N2	Exempt tax 4?	Yes = 1 No = 0		
	The tender is allowed in any amount?	Yes = 2 No = 0		
	Food stamp change is issued in:	Cash = 4 Food Stamps = 0		
N3	Open cash drawer?	Yes = 0 No = 1		
	Validation is compulsory?	Yes = 2 No = 0		
	Allow over-tender?	Yes = 4 No = 0		

GUEST - Function Key Options

Options - Program 70 (P-Mode)

Repeat for another function

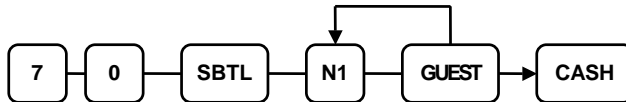

Address	OPTION	VALUE	=	SUM
N1	Guest count entry compulsory when you use guest check operation?	Yes = 1 No = 0		
	Before registering any transactoin, enter a guest count?	Yes = 2 No = 0		
	Print Guest # at the kitchen printer?	Yes = 4 No = 0		

#/NS - Function Key Options

Options - Program 70 (P-Mode)

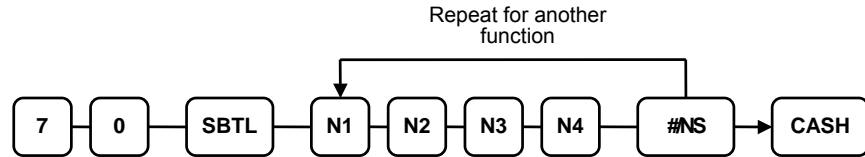

Address	OPTION	VALUE	=	SUM
N1	No Sale is inactive?	Yes = 1 No = 0		
	No Sale active in X control lock position only?	Yes = 2 No = 0		
	No Sale inactive after non-add # entry?	Yes = 4 No = 0		
N2	Enforce non-add # entry at start of sale?	Yes = 1 No = 0		
	Print when a NO SALE is performed?	Yes = 0 No = 2		
	Non-add # entries are prohibited?	Yes = 4 No = 0		
N3	Compulsory non-add entry must match number of digits set in the MAX DIGIT flag below?	Yes = 1 No = 0		
	Print non-add on guest check?	Yes = 2 No = 0		
N4	Enter maximum number of digits for non-add number entry. Zero (0) means no limit.	0-8		

MDSE RETURN - Function Key Options

Options - Program 70 (P-Mode)

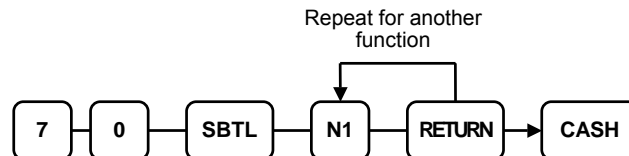

Address	OPTION	VALUE	=	SUM
N1	Key is inactive?	Yes = 1 No = 0		
	Key is active in X control lock position only?	Yes = 2 No = 0		
	Validation is compulsory?	Yes = 4 No = 0		

MODIFIER 1-5 - Function Key Options

Options - Program 70 (P-Mode)

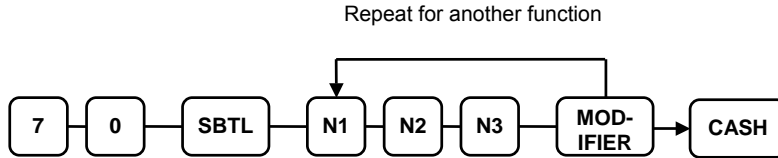

Address	OPTION	VALUE	=	SUM
N1	Key is active in X control lock position only?	Yes = 1 No = 0		
	Affect PLU number? (If No, only modifier descriptor is added.)	Yes = 2 No = 0		
N2	Print modifier descriptor on the guest check?	Yes = 1 No = 0		
	Print modifier descriptor on the receipt?	Yes = 2 No = 0		
N3	Value of affected digit (0-9)	0-9		

To set Affected Digit (1-4) of PLU#:

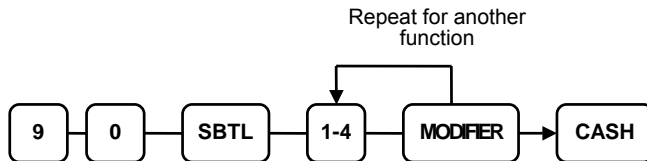

PBAL - Function Key Options

Options - Program 70 (P-Mode)

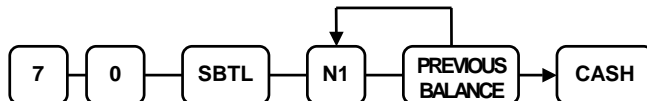

Address	OPTION	VALUE	=	SUM
N1	Previous balance may be entered at any time?	Yes = 1 No = 0		
	Previous balance required at the start of the sale?	Yes = 2 No = 0		

PROMO - Function Key Options

Options - Program 70 (P-Mode)

Repeat for another function

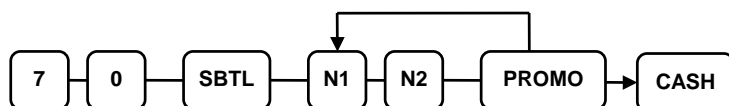

Address	OPTION	VALUE	=	SUM
N1	Key is inactive?	Yes = 1 No = 0		
	Key is active in X control lock position only?	Yes = 2 No = 0		
	Exempt tax 1?	Yes = 4 No = 0		
N2	Exempt tax 2?	Yes = 1 No = 0		
	Exempt tax 3?	Yes = 2 No = 0		
	Exempt tax 4?	Yes = 4 No = 0		

PAID OUT 1-3 - Function Key Options

Options - Program 70 (P-Mode)

Repeat for another function

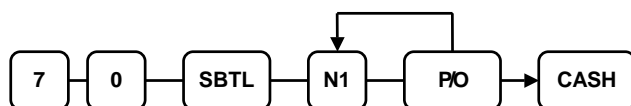

Address	OPTION	VALUE	=	SUM
N1	Key is inactive?	Yes = 1 No = 0		
	Key is active in X control lock position only?	Yes = 2 No = 0		
	Validation is compulsory?	Yes = 4 No = 0		

PRINT CHECK - Function Key Options

Options - Program 70 (P-Mode)

Repeat for another function

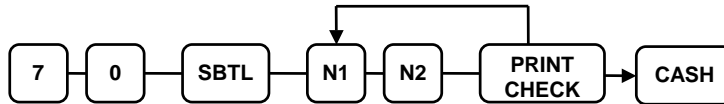

Address	OPTION	VALUE	=	SUM
N1	Enter port. (Zero if the check will print on the receipt printer)	0-2		
N2	Automatically service the check?	Yes = 1 No = 0		
	Skip printing consecutive # on the guest check?	Yes = 2 No = 0		

RECD ON ACCT 1-3 - Function Key Options

Options - Program 70 (P-Mode)

Repeat for another function

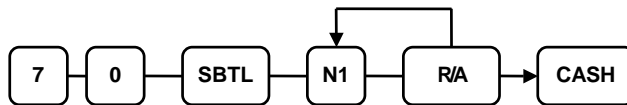

Address	OPTION	VALUE	=	SUM
N1	Key is inactive?	Yes = 1 No = 0		
	Key is active in X control lock position only?	Yes = 2 No = 0		
	Validation is compulsory?	Yes = 4 No = 0		

SCALE - Function Key Options

Options - Program 70 (P-Mode)

Repeat for another function

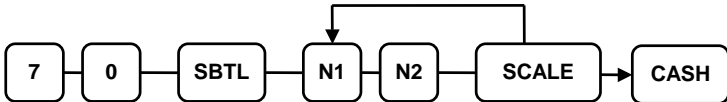

Address	OPTION	VALUE	=	SUM
N1	Key is inactive?	Yes = 1 No = 0		
	Key is active in X control lock position only?	Yes = 2 No = 0		
	Allow manual entry of weight?	Yes = 4 No = 0		
N2	Subtract tare weight on the scale entry?	Yes = 1 No = 0		
	Weight symbol for manual entry is:	Kg = 2		
		Lb = 0		
	Scaleable items can be open price or scaleable entry.	Yes = 4 No = 0		

SERVICE - Function Key Options

Options - Program 70 (P-Mode)

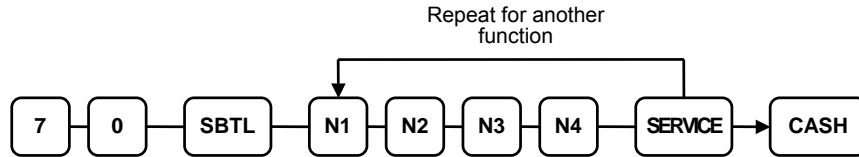

Address	OPTION	VALUE	=	SUM
N1	Compulsory non-add number before this key is used?	Yes = 1 No = 0		
	Print on receipt?	Yes = 0 No = 2		
	Allow negative balance in X control lock position only?	Yes = 4 No = 0		
N2	Calculate tax 1?	Yes = 0 No = 1		
	Calculate tax 2?	Yes = 0 No = 2		
	Calculate tax 3?	Yes = 0 No = 4		
N3	Calculate tax 4?	Yes = 0 No = 1		
	Validation is compulsory?	Yes = 2 No = 0		
N4	Enter the port number if you are using a hard check system.	0,1,2		

SUBTOTAL - Function Key Options

Options - Program 70 (P-Mode)

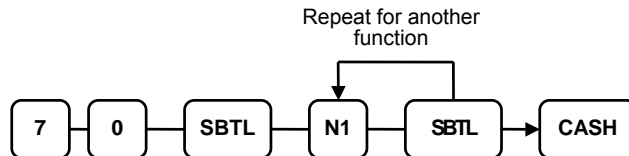

Address	OPTION	VALUE	=	SUM
N1	Key is inactive?	Yes = 1 No = 0		

TABLE - Function Key Options

Options - Program 70 (P-Mode)

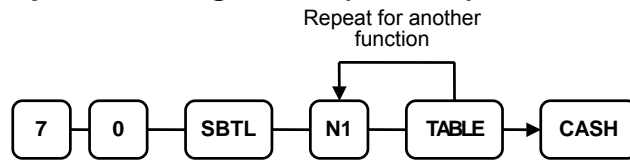

Address	OPTION	VALUE	=	SUM
N1	Table number entry compulsory before opening a new check?	Yes = 1 No = 0		
	Table number entry compulsory for all sales?	Yes = 2 No = 0		
	Print table# at the remote printer?	Yes = 4 No = 0		

TARE - Function Key Options

Options - Program 70 (P-Mode)

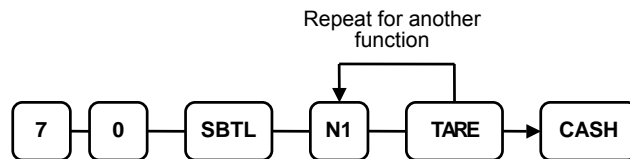

Address	OPTION	VALUE	=	SUM
N1	Key is inactive?	Yes = 1 No = 0		
	Key is active in X control lock position only?	Yes = 2 No = 0		
	Using number 5 to manually enter a tare weight?	Yes = 4 No = 0		

TAX EXEMPT - Function Key Options

Options - Program 70 (P-Mode)

Repeat for another function

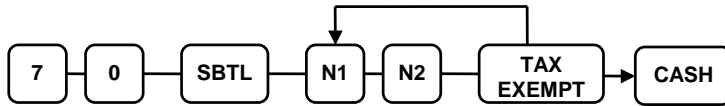

Address	OPTION	VALUE	=	SUM
N1	Exempt tax 1?	Yes = 1 No = 0		
	Exempt tax 2?	Yes = 2 No = 0		
	Exempt tax 3?	Yes = 4 No = 0		
N2	Exempt tax 4?	Yes = 1 No = 0		
	Compulsory non-add number before this key is used?	Yes = 2 No = 0		
	Validation is compulsory?	Yes = 4 No = 0		

TIP - Function Key Options

Options - Program 70 (P-Mode)

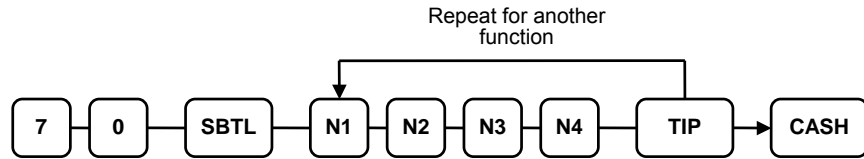

Address	OPTION	VALUE	=	SUM	
N1	Type of tip is:	Percentage =	1		
		Amount =	0		
N2	Key is inactive?	Yes = 1 No = 0			
	Key is active in X control lock position only?	Yes = 2 No = 0			
	Add tax rate 1?	Yes = 4 No = 0			
N3	Add tax rate 2?	Yes = 1 No = 0			
	Add tax rate 3?	Yes = 2 No = 0			
	Add tax rate 4?	Yes = 4 No = 0			
N4	Add the tip total to the NET and GROSS sales total?	Yes = 1 No = 0			

VALIDATE - Function Key Options

Options - Program 70 (P-Mode)

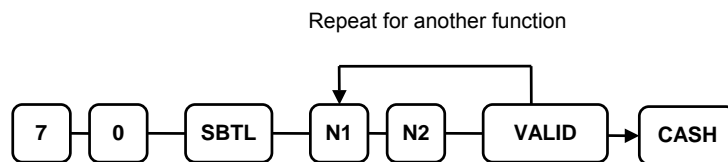

Address	OPTION	VALUE	=	SUM
N1	Enter output communication port. Enter Zero if validation is not used.	0-2		
N2	This function is disabled?	Yes = 1 No = 0		
	Allow multiple validations?	Yes = 2 No = 0		

VOID - Function Key Options

Options - Program 70 (P-Mode)

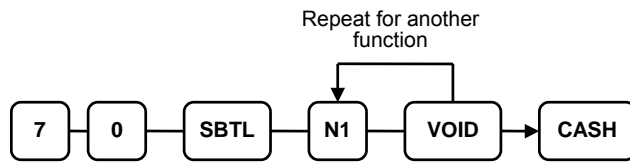

Address	OPTION	VALUE	=	SUM
N1	Key is inactive?	Yes = 1 No = 0		
	Key is active in X control lock position only?	Yes = 2 No = 0		

WASTE - Function Key Options

Options - Program 70 (P-Mode)

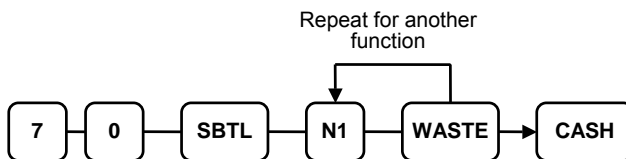

Address	OPTION	VALUE	=	SUM
N1	Key is inactive?	Yes = 1 No = 0		
	Key is active in X control lock position only?	Yes = 2 No = 0		
	Validation is compulsory?	Yes = 4 No = 0		

%1-%5 Function Key Options

Options - Program 70 (P-Mode)

Note: See "Program 90 Instructions for %1-%5 Keys" on page 122 to set the value for the percentage or amount.

Repeat for another function

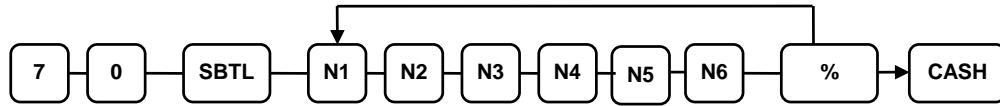

Address	OPTION	VALUE	=	SUM	
N1	Apply an:	Amount =	1		
		Percentage =	0		
	Key is inactive?	Yes = 2 No = 0			
	% Key is active in X control lock position only?	Yes = 4 No = 0			
N2	% Key is:	Open =	1		
		Preset =	0		
	% Key is:	Sale =	2		
		Item =	0		
	Allow % key override preset?	Yes = 4 No = 0			
N3	% Key is:	Positive =	1		
		Negative =	0		
	%/Amount taxable tax 1?	Yes = 2 No = 0			
N4	% /Amount taxable tax 2?		Yes = 1 No = 0		
	% /Amount taxable tax 3?		Yes = 2 No = 0		
	% /Amount taxable tax 4?		Yes = 4 No = 0		
N5	Reduce (or increase) the food stamp subtotal by % entry?		Yes = 1 No = 0		
	Allow only one time subtotal entry?		Yes = 2 No = 0		
	Allow multiple amount discounts (coupons) without pressing subtotal?		Yes = 4 No = 0		
N6	Allow % key preset override active in X control lock position only?		Yes = 1 No = 0		
	Validation is compulsory?		Yes = 2 No = 0		
	Affect Net Sales Total?		Yes = 0 No = 4		

Mix and Match Discount Programming

Retailers often offer discounts when multiples of different items are purchased. For example, the offer: “save \$5 on any three bottles of wine” can be handled by a mix and match discount. The ER-5200M/5240M can accommodate up to 99 different mix and match discounts.

Tables have the following programming options that are set through separate programs:

- Program 600 – Trip Level Programming – This program sets the number of items that must be purchased to receive the discount
- Program 601 – Price Programming – This program sets the amount of the discount.
- Program 610 – Mix & Match Descriptor – This program allows you to set a unique, up to 18-character, descriptor for each Mix & Match discount.

You also must link eligible items to the appropriate table. See “Program 450 – PLU Mix and Match Programming” on page 111 to identify the mix and match table for the eligible PLU.

Program 600 – Trip Level Programming

1. Turn the control lock to the **P** position.
2. To begin the program, enter **6 0 0**, press the **SBTL** key.

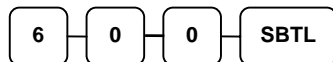

3. Enter the number (**1-99**) of the mix and match table you wish to program; press the **X/TIME** key.

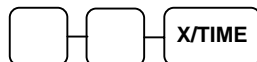

4. Enter a level of up to 5 digits (the Maximum Level you can enter is 50000) and press the **SBTL** key.

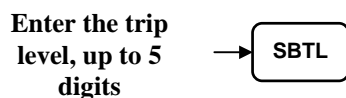

5. Repeat from step 3 for each table you wish to program. Press the **CASH** key to finalize the program.



Program 601 – Price Programming

1. Turn the control lock to the **P** position.
2. To begin the program, enter **6 0 1**, press the **SBTL** key.



3. Enter the number (**1-99**) of the mix and match table you wish to program; press the **X/TIME** key.



4. Enter a price (up to 7 digits) and press the **SBTL** key.



5. Repeat from step 3 for each table you wish to program. Press the **CASH** key to finalize the program.



Program 610 – Mix & Match Descriptor Programming

Program descriptors by typing descriptors on the alpha keyboard overlay or by entering three digit alpha character codes. To enter descriptors by three digit alpha character codes you must add a value of '1' to system option #25 (See "System Option Programming" on page 112).

1. Turn the control lock to the **P** position.
2. To begin the program, enter **6 1 0**, press the **SBTL** key.



3. Enter the number (1-99) of the M&M table you wish to program; press the **X/TIME** key.



4. If you are programming using an alpha keyboard overlay, type up to 18 descriptors on the overlay and press the **SBTL** key.



If you are programming using descriptor codes, enter up to 18 three-character codes and press the **SBTL** key.

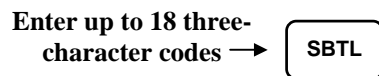

5. Press the **CASH** key to finalize the program.

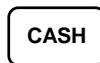

Clerk Programming

Clerks (which may be used as cashiers), have the following programming options. These options are set through separate programs:

- *Program 800 - Secret Code programming* determines the code that is used for clerk sign on if a code entry sign on method is selected in system option #2 (See "System Option Programming" on page 112.)
- *Program 801* - If a second cash drawer is installed, *Drawer Assignment* determines which cash drawer will be opened for each.
- *Program 810 - Clerk Descriptor Programming* allows you to set a unique, up to 18 character, descriptor for each clerk

Before attempting any programming, all clerks must first be signed off in REG mode.

Program 800 - Secret Code Programming

1. Turn the control lock to the **P** position.
2. To begin the program, enter **8 0 0**, press the **SBTL** key.

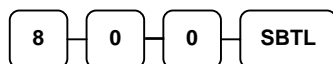

3. Enter the number (**1-99**) of the clerk you wish to program; press the **X/TIME** key.



4. Enter a secret code (up to 6 digits); press the **SBTL** key.

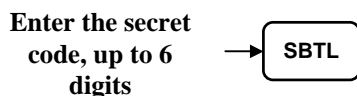

5. Repeat from step 3 for each clerk you wish to program. Press the **CASH** key to finalize the program.



Program 801 - Drawer Assignment

1. Turn the control lock to the **P** position.
2. To begin the program, enter **8 0 1**, press the **SBTL** key.



3. Enter the number (1-99) of the clerk you wish to program; press the **X/TIME** key.



4. Enter a drawer assignment (**0** (no drawer), **1** (default), or **2**); press the **SBTL** key.

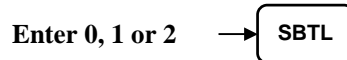

5. Repeat from step 3 for each clerk you wish to program. Press the **CASH** key to finalize the program.

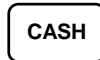

Program 810 - Clerk Descriptor Programming

Program descriptors by typing descriptors on the alpha keyboard overlay or by entering three digit alpha character codes. To enter descriptors by three digit alpha character codes you must add a value of '1' to system option #25 (See "System Option Programming" on page 112).

1. Turn the control lock to the **P** position.
2. To begin the program, enter **8 1 0**, press the **SBTL** key.



3. Enter the number (1-99) of the clerk you wish to program; press the **X/TIME** key.



4. If you are programming using an alpha keyboard overlay, type up to 18 descriptors on the overlay and press the **SBTL** key.

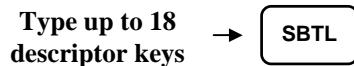

If you are programming using descriptor codes, enter up to 18 three-character codes and press the **SBTL** key.

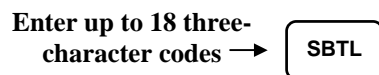

5. Press the **CASH** key to finalize the program.

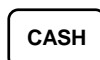

Group Programming

20 Group totals are available to accumulate totals of individual PLUs that are assigned to each group. Each PLU can be assigned to one, two or three different groups. (See "Program 150 - PLU Group Assignment" on page 103 to program PLU groups for each PLU.)

- Use program 900 to assign a group status, i.e. a group can be set to *not add* to the total of all groups, or a group can be used to designate like items for kitchen printer assignment.
- Use program 910 to assign a unique descriptor for each group, so that the group may be easily understood on the group report.

Program descriptors by typing descriptors on the alpha keyboard overlay or by entering three digit alpha character codes. To enter descriptors by three digit alpha character codes you must add a value of '1' to system option #25 (See "System Option Programming" on page 112).

Programming Group Status - Program 900

1. Turn the control lock to the **P** position.
2. To begin the program, enter **9 0 0**, press the **SBTL** key.

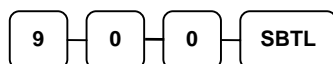

3. Enter the number (**1-99**) of the group you wish to program; press the **X/TIME** key.



4. Enter an option digit from the table below, press the **SBTL** key.

Address	OPTION	VALUE	=	SUM
N1	Group total is added to the total of all groups on the Group report?	Yes = 0 No = 1		
	Send to kitchen printer?	Yes = 2 No = 0		
N2	No Choice	0		
	KP PORT# : R(requisition on the register receipt)	1		
	KP PORT#: 1	2		
	KP PORT#: 2	4		
N3	Print RED on KP?	Yes = 1 No = 0		



5. To program additional groups, repeat from step 3, or press the **CASH** key to finalize the program.

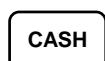

Programming Group Descriptors

1. Turn the control lock to the **P** position.
2. To begin the program, enter **9 1 0**, press the **SBTL** key.



3. Enter the number (**1-99**) of the group you wish to program; press the **X/TIME** key.

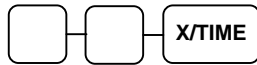

4. If you are programming using an alpha keyboard overlay, type up to 18 descriptors on the overlay and press the **SBTL** key.



If you are programming using descriptor codes, enter up to 18 three-character codes and press the **SBTL** key.

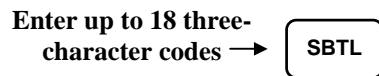

5. To program additional groups, repeat from step 3, or press the **CASH** key to finalize the program.

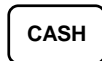

Miscellaneous Programming

Program 1500 - Macro Key Sequence Programming

Macros are special function keys that are used to execute a sequence of key depressions. For example, a macro might be used to execute a string of reports or to automatically tender a preset amount. Up to ten different macros may be placed on the keyboard. (See "Function Key Assignment Programming" on page 84 to place macros on the keyboard.)

To Program a Macro

1. Turn the control lock to the **P** position.
2. To begin the program, enter **1 5 0 0**, press the **SBTL** key.

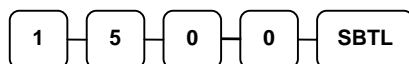

3. Press the **Macro** key that you wish to program.

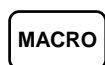

4. Optionally, you can turn the key lock to the to the position where you wish the macro to set the register. For example, if wish the macro to set the key lock to **X** to run a report, turn the key lock to **X**. When used in the **REG** position, the macro will set the register to **X** and run the report. If you do not adjust the key lock here, the macro will execute the programmed keystrokes in **any** key position.
5. Press up to 50 keystrokes that you wish the macro to execute.

**Type up to 50
keystrokes**

6. Return the key lock to the P position and press the macro key to finalize.

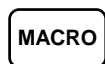

7. Repeat from step 3 to program additional macros. Press the **CASH** key to finalize the program.

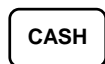

To Remove a Macro

If you wish to change a macro sequence change the function key assignment of the key to '**Inactive**', and then reassign the macro function and reprogram the keystrokes as shown above. (See "Function Key Assignment Programming" on page 84.)

Program 700 – Logo/Endorsement Message Programming

Programming the Receipt/Check Endorsement Message

A preamble message of up to six lines can be printed at the top of each receipt; a postamble message of up to six lines can be printed at the bottom of each receipt, and an endorsement message of up to ten lines can be printed when a check is endorsed on an optional slip printer. Each line can consist of up to 32 characters.

1. Turn the control lock to the **P** position.
2. To begin the program, enter **7 0 0**, press the **SBTL** key.



3. Refer to the chart below and enter the number that represents the line you wish to program; press the **X/TIME** key.

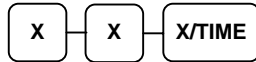

X	Message Line	X	Message Line
1	1 st line of Preamble	12	6 th line of Postamble
2	2 nd line of Preamble	13	1 st line of Endorsement
3	3 rd line of Preamble	14	2 nd line of Endorsement
4	4 th line of Preamble	15	3 rd line of Endorsement
5	5 th line of Preamble	16	4 th line of Endorsement
6	6 th line of Preamble	17	5 th line of Endorsement
7	1 st line of Postamble	18	6 th line of Endorsement
8	2 nd line of Postamble	19	7 th line of Endorsement
9	3 rd line of Postamble	20	8 th line of Endorsement
10	4 th line of Postamble	21	9 th line of Endorsement
11	5 th line of Postamble	22	10 th line of Endorsement

4. If you are programming using an alpha keyboard overlay, type up to 32 descriptors on the overlay and press the **SBTL** key.

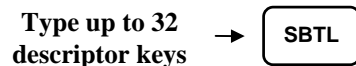

If you are programming using descriptor codes, enter up to 32 three-character codes and press the **SBTL** key.

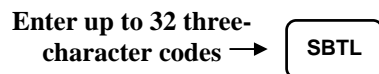

5. Press the **CASH** key to finalize the program.

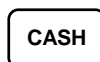

Program 701 - Financial Report Descriptor Programming

The Financial Report selection allows you to reprogram the descriptors that appear with the Financial Report totals and counters. For example, the first total on the financial report "+PLU TTL" represents the total of all positive PLU entries. You might wish to re-label this total to say "FOOD SALES". You can reprogram any of the Financial Report totals listed here with any 12-character descriptor.

1. Turn the control lock to the **P** position.
2. To begin the program, enter **7 0 1**, press the **SBTL** key.

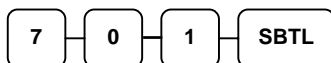

3. Refer to the chart on the next page and enter the number that represents the line you wish to program; press the **X/TIME** key.

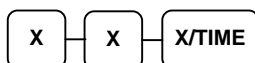

4. If you are programming using an alpha keyboard overlay, type up to 18 descriptors on the overlay and press the **SBTL** key.

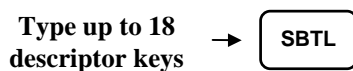

If you are programming using descriptor codes, enter up to 18 three-character codes and press the **SBTL** key.

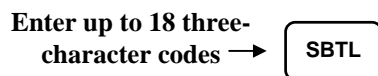

5. Press the **CASH** key to finalize the program.

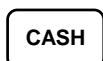

X	Message Line	X	Message Line	X	Message Line
1	+PLU TTL	30	FD/S CREDIT	59	CHG1 SALES
2	-PLU TTL	31	RETURN	60	CHG2 SALES
3	ADJST TTL	32	ERROR CORR	61	CHG3 SALES
4	NONTAX	33	PREVIOUS VD	62	CHG4 SALES
5	TAX1 SALES	34	VOID MODE	63	CHG5 SALES
6	TAX2 SALES	35	CANCEL	64	CHG6 SALES
7	TAX3 SALES	36	GROSS SALES	65	CHG7 SALES
8	TAX4 SALES	37	CASH SALES	66	CHG8 SALES
9	TAX1	38	CHECK SALES	67	FOREIGN 1
10	TAX2	39	R/A 1	68	FOREIGN 2
11	TAX3	40	R/A 2	69	FOREIGN 3
12	TAX4	41	R/A 3	70	FOREIGN 4
13	XMPT1 SALES	42	P/O 1	71	DRWR TTL
14	XMPT2 SALES	43	P/O 2	72	PROMO
15	XMPT3 SALES	44	P/O 3	73	WASTE
16	XMPT4 SALES	45	HASH TTL	74	TIP
17	EATIN TTL	46	AUDACTION	75	TRAIN TTL
18	TAKEOUT TTL	47	NOSALE	76	BAL FORWARD
19	DRTHRU TTL	48	CASH-IN-D	77	GUESTS
20	% 1	49	CHECK-IN-D	78	P/BAL
21	% 2	50	FD/S-IN-D	79	CHECKS PAID
22	% 3	51	CHG1-IN-D	80	SERVICE
23	% 4	52	CHG2-IN-D	81	MIX&MATCH
24	% 5	53	CHG3-IN-D	82	PAYMENT TTL
25	NET SALE	54	CHG4-IN-D	83	OPEN CHK TTL
26	CREDIT TAX1	55	CHG5-IN-D		
27	CREDIT TAX2	56	CHG6-IN-D		
28	CREDIT TAX3	57	CHG7-IN-D		
29	CREDIT TAX4	58	CHG8-IN-D		

Program 710 - Clerk Report Descriptor Programming

The Clerk Report selection allows you to reprogram the descriptors that appear with the Clerk Report totals and counters. For example, the first total on the clerk report "NET SALES" might be re-labeled to say "GROSS SALES". You can reprogram any of the Financial Report totals listed here with any 12-character descriptor.

1. Turn the control lock to the **P** position.
2. To begin the program, enter **7 1 0**, press the **SBTL** key.

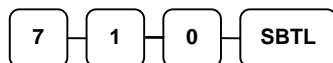

3. Refer to the chart on the next page and enter the number that represents the line you wish to program; press the **X/TIME** key.

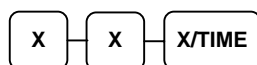

4. If you are programming using an alpha keyboard overlay, type up to 18 descriptors on the overlay and press the **SBTL** key.

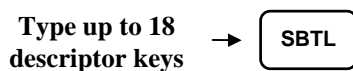

If you are programming using descriptor codes, enter up to 18 three-character codes and press the **SBTL** key.

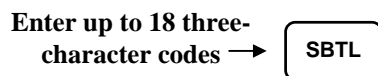

5. Press the **CASH** key to finalize the program.

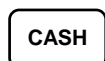

X	Message Line	X	Message Line	X	Message Line
1	NET SALE	26	CREDIT TAX4	51	CHG6 SALES
2	NONTAX	27	FD/S CREDIT	52	CHG7 SALES
3	TAX1 SALES	28	RETURN	53	CHG8 SALES
4	TAX2 SALES	29	ERROR CORR	54	FOREIGN 1
5	TAX3 SALES	30	PREVIOUS VD	55	FOREIGN 2
6	TAX4 SALES	31	VOID MODE	56	FOREIGN 3
7	TAX1	32	CANCEL	57	FOREIGN 4
8	TAX2	33	GROSS SALES	58	DRWR TTL
9	TAX3	34	CASH SALES	59	PROMO
10	TAX4	35	CHECK SALES	60	WASTE
11	XMPT1 SALES	36	R/A 1	61	TIP
12	XMPT2 SALES	37	R/A 2	62	TRAIN TTL
13	XMPT3 SALES	38	R/A 3	63	BAL FORWARD
14	XMPT4 SALES	39	P/O 1	64	GUESTS
15	EATIN TTL	40	P/O 2	65	P/BAL
16	TAKEOUT TTL	41	P/O 3	66	CHECKS PAID
17	DRTHRU TTL	42	HASH TTL	67	SERVICE
18	% 1	43	CASH-IN-D	68	NOSALE
19	% 2	44	CHECK-IN-D	69	MIX&MATCH
20	% 3	45	FD/S-IN-D	70	PAYMENT
21	% 4	46	CHG1 SALES		
22	% 5	47	CHG2 SALES		
23	CREDIT TAX1	48	CHG3 SALES		
24	CREDIT TAX2	49	CHG4 SALES		
25	CREDIT TAX3	50	CHG5 SALES		

Program 711 - Macro Name Programming

Up to ten function locations may be designated as Macro keys. You may wish to program a name for a macro. For example if a macro executes a series of commands to produce daily reports, you can program the descriptor "DAILY", so the macro can easily be identified. Macro names can also be helpful when looking at keyboard layout information with the PC communication utility.

1. Turn the control lock to the **P** position.
2. To begin the program, enter **7 1 1**, press the **SBTL** key.

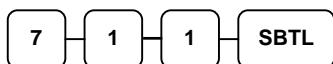

3. Enter the number of the Macro you wish to program (1-10); press the **X/TIME** key.



4. If you are programming using an alpha keyboard overlay, type up to 18 descriptors on the overlay and press the **SBTL** key.

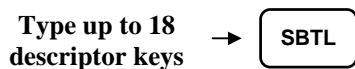

If you are programming using descriptor codes, enter up to 18 three-character codes and press the X/TIME key. (See "Descriptor Code Chart" on page 99.)

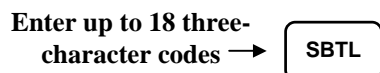

5. Press the **CASH** key to finalize the program.



Program 720 – DataTran Message Program

When a DataTran integrated payment appliance is connected, you can print a message of up to four lines on the electronic payment draft receipt.

1. Turn the control lock to the **P** position.
2. To begin the program, enter **7 2 0**, press the **SBTL** key.

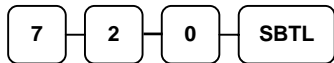

3. Enter the number of the message line (1-4) you wish to program; press the **X/TIME** key.



4. If you are programming using an alpha keyboard overlay, type up to 32 descriptors on the overlay and press the **SBTL** key.



If you are programming using descriptor codes, enter up to 32 three-character codes and press the X/TIME key. (See “Descriptor Code Chart” on page 99.)

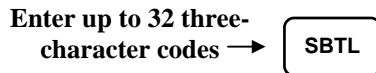

5. Press the **CASH** key to finalize the program.

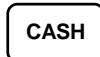

Program 1000 - NLU Code Number Programming

NLU are fixed keys on the keyboard (like traditional department keys) that access specific PLUs.

On the ER-5200M default keyboard, there are 117 NLU keys (15 NLU keys on the 5240M) and the PLU# assigned to the NLU key is the same, i.e. NLU key number one is PLU #1. However, with this program, you can assign any PLU number you wish to any one of the NLU keys.

Programming the NLU Code Number

1. Turn the control lock to the **P** position.
2. To begin the program, enter **1 0 0 0**, press the **SBTL** key.

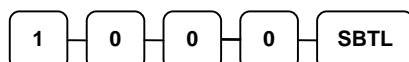

3. Enter the new PLU code number you wish to use for this NLU key, and press the NLU key on the keyboard you wish to program. Press the same NLU key again.

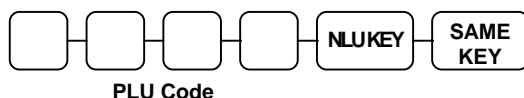

4. Repeat step #3 to program additional NLU locations, or press **CASH** to finalize the program

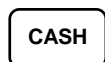

Program 1100 - Cash-In-Drawer Limit Programming

You can set a cash-in-drawer limit. When cash in drawer exceeds the limit a warning will display on the screen. You must press CLEAR to remove the warning and continue operations. The warning will continue to appear at the completion of every transaction with the limit exceeded, until you use the PAID OUT function to remove cash from the drawer.

Programming the Drawer Limit

1. Turn the control lock to the **P** position.
2. To begin the program, enter **1 1 0 0**, press the **SBTL** key.

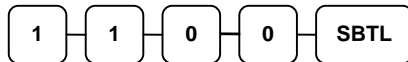

3. Enter a cash-in-drawer limit (up to 8 digits or **0** for no limit); press the **X/TIME** key.

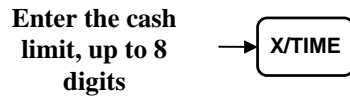

4. Press the **CASH** key to finalize the program.

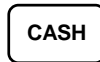

Program 1200 - Check Change Limit Programming

Use this program to set the maximum amount of cash that can be returned when a check is tendered for an amount greater than the amount of the sale. For example, if the check change limit is \$10.00 the maximum amount that can be tendered into the check key on a \$5.00 sale is \$15.00.

Programming the Check Change Limit

1. Turn the control lock to the **P** position.
2. To begin the program, enter **1 2 0 0**, press the **SBTL** key.

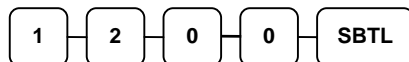

3. Enter a cash-in-drawer limit (up to 8 digits or **0** for no limit); press the **X/TIME** key.

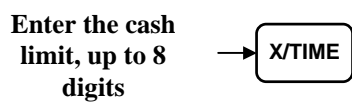

4. Press the **CASH** key to finalize the program.

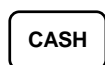

Program 1300 - Date and Time Programming

Use this program to set the clock and calendar on your ER5200M/5240M. The date changes automatically. After initial setting, time changing will probably be required only for beginning and ending daylight savings time.

Programming the Date and Time

1. Turn the control lock to the **P** position.
2. To begin the program, enter **1 3 0 0**, press the **SBTL** key.

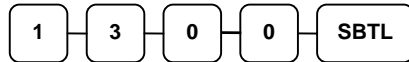

3. Enter time in military standard time (based on 24 hours), must be four digits (i.e. 1300 hours = 1:00 PM); press the **X/TIME** key.

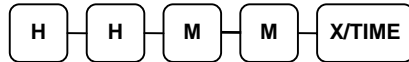

4. Enter the date in MM(month) DD(day) and YY(year) format. Press the **X/TIME** key:



5. Press the **CASH** key to finalize the program.

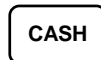

Program 1400 - Scale Tare Weight Programming

A tare is the amount of weight representing the container, or package when items are sold by weight. You can pre-program five tare weights, representing the weight of different containers. When you place an item and a container on optional scale, you can enter the tare number to automatically subtract the pre-programmed tare weight.

If you choose to use tare #5 for manual tare weight entry, do not enter a weight for tare #5. (See Scale Operations on page 68.)

1. Turn the control lock to the **P** position.
2. To begin the program, enter **1 4 0 0**, press the **SBTL** key.

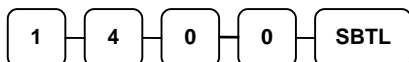

3. Enter the number (**1-5**) of the tare you wish to program; press the **X/TIME** key.

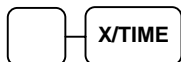

4. Enter the weight of the tare (one digit preceding the decimal key, the decimal key, then three digits after the decimal key). Press the **SBTL** key.



5. To program additional tare weights, repeat from step 3, or press the **CASH** key to finalize the program.

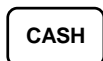

Program 1600 - Machine Number Programming

The machine number is printed on the register receipt. Program a machine number so that any receipt or journal can be identified with the store or register where the transaction took place.

Programming the Machine Number

1. Turn the control lock to the **P** position.
2. To begin the program, enter **1 6 0 0**, press the **SBTL** key.

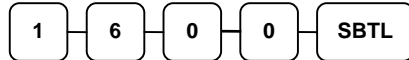

3. Enter a machine number (up to 5 digits); press the **X/TIME** key.



4. Press the **CASH** key to finalize the program.



Program 1900 – Starting Kitchen Printer Order Number

When using a kitchen printer or requisition receipt, you can program the starting order number that will appear on the requisition. When a Z1 financial report is taken, the requisition number will reset and begin again at the number set here. (This feature is available in software version 5.4 or later.)

Programming the Starting KP Order Number

1. Turn the control lock to the **P** position.
2. To begin the program, enter **1 9 0 0**, press the **SBTL** key.

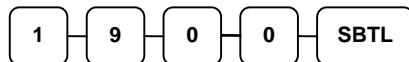

4. Enter the starting number (up to 4 digits); press the **X/TIME** key.



5. Press the **CASH** key to finalize the program.

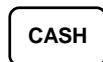

Program Scans

Since much time and energy has been invested in the planning and programming of your *ER-5200M/5240M*, it is advisable to print a hard copy of the final program for future reference. This copy should be kept in a safe place.

1. Turn the control lock to the **P** position.
2. To print a program scan, enter **1 5**, press the **SBTL** key.

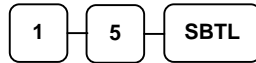

3. Refer to the chart below and enter a digit to represent the segment of the program you wish to print; press the **X/TIME** key.

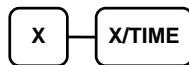

X	Program	X	Program
0	Group	9	Financial Report message
1	Tax	10	Clerk Report message
2	System option	11	Macro Name
3	Print option	12	Drawer Limit
4	Function keys	13	Check Change Limit
5	Clerk	14	Time & Date
6	Preamble message	15	Tare Weight
7	Postamble message	16	Machine Number
8	Endorsement message	17	Mix & Match

4. To read PLU program information, enter the number of the first PLU in a range of PLUs that are to be scanned; press the **PLU** key. Enter the last number in the range; press the **PLU** key, or



Press the first PLU keys that are to be scanned and Press the last PLU keys,



5. To read MACRO information, press the **MACRO** key to be scanned,

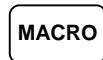

6. To read additional parts of the program, repeat from step 3, or press the **CASH** key to finalize the program.

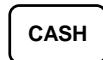

Sample Reports

Financial

	DATE 11/10/1999 WED	TIME 13:32
	X 1 REPORT	00001

	FINANCIAL	
Total and count of all positive PLUs	+PLU TTL	179.56
Total and count of all Negative PLUs		\$288.60
Total of +PLU and -PLU sales	-PLU TTL	10
Total of Non-taxable sales		-20.00
Total of tax eligible sales for each sale tax	ADJUST TTL	189.56
Total of tax collected for each tax		\$268.60
Total exempted sales for each tax	-----	
Total sales for each type of destination	NONTAX	\$30.47
Total and count for each % function key (i.e. discounts & coupons)	TAX1 SALES	\$153.60
	TAX2 SALES	\$11.92
	TAX3 SALES	\$16.77
	TAX4 SALES	\$31.89
	TAX1	\$10.00
	TAX2	\$1.21
	TAX3	\$1.18
	TAX4	\$2.18
	XMPT1 SALES	\$7.00
	XMPT2 SALES	\$1.50
	XMPT3 SALES	\$7.95
	XMPT4 SALES	\$7.50
	EATIN TTL	1
		\$10.12
	TAKEOUT TTL	2
		\$40.77
	DRTHRU TTL	1
		\$3.04
	ITEM DISC.	3
		-0.48
	continued . . .	

continued from previous page

Total and count for each % function key (i.e. discounts & coupons)

Net Sales

Credited tax for each tax. (Tax is credited for negative taxable sales, i.e. mdse return transactions.)

Food stamp change credited to sales

Total and count for each type of transaction correction.

Gross Sales

Totals and counters for CASH and CHECK sales

Total and count for each type R/A (received on account) and P/O (paid out) key.

SALE DISC.	2
	-5.22
SALE SURCH.	3
	\$3.23
% 4	0
	\$0.00
% 5	0
	\$0.00
NET SALE	26
	\$281.18
CREDIT TAX1	4
	-1.11
CREDIT TAX2	1
	-0.23
CREDIT TAX3	2
	-0.89
CREDIT TAX4	1
	-0.39
FD/S CREDIT	0
	\$0.23
RETURN	33
	-59.73
ERROR CORR	2
	-4.00
PREVIOUS VD	1
	-1.50
VOID MODE	-2
	-6.40
CANCEL	2
	\$16.00
GROSS SALES	\$375.63
CASH SALES	13
	\$133.49
CHECK SALES	1
	\$23.05
R/A 1	1
	\$145.00
R/A 2	0
	\$0.00
R/A 3	0
	\$0.00
P/O 1	1
	-140.00
P/O 2	0
	\$0.00
P/O 3	0
	\$0.00

continued . . .

Total and count of items sold with HASH status.

Count of No Sales.

Total of numbers entered into the non-add key

Total and count of expected CASH, CHECK in drawer

Total and count for each CHARGE in drawer.

Total and count for each CHARGE key.

Total for each Foreign currency in drawer.

continued from previous page

HASH TTL	0
	\$0.00
NOSALE	4
NON ADD #	547
CASH-IN-D	14
	\$269.99
CHECK-IN-D	3
	-108.45
FD/S-IN-D	2
	\$21.00
CHG1-IN-D	0
	\$0.00
CHG2-IN-D	1
	\$8.43
CHG3-IN-D	1
	\$8.52
CHG4-IN-D	2
	-1.60
CHG5-IN-D	1
	\$2.67
CHG6-IN-D	2
	\$13.09
CHG7-IN-D	0
	\$0.00
CHG8-IN-D	1
	\$0.00
CHG1 SALES	0
	\$0.00
CHG2 SALES	1
	\$8.43
CHG3 SALES	1
	\$8.52
CHG4 SALES	2
	-1.60
CHG5 SALES	1
	\$2.67
CHG6 SALES	2
	\$13.09
CHG7 SALES	0
	\$0.00
CHG8 SALES	1
	\$3.04
FOREIGN 1	0.00
FOREIGN 2	0.00
FOREIGN 3	0.00
FOREIGN 4	0.00

continued . . .

Total of CASH, CHECKS and CHARGES in drawer.

Total and count for PROMO, WASTE and TIPS.

Number of transactions and total activity in Training Mode

Total and count of all balances serviced

Total number of guests served

Total and count of balances entered into PBAL key

Total and count of balances paid

Total and count of items serviced

Total and count of mix & match disc.

Total and count of payments to house accounts

Total of open check (from open check report.) Will not reset with financial Z report.

Average number if items per customer, and average dollar sales per customer

Grand total

continued from previous page

DRWR TTL	\$216.69
PROMO	1
	\$1.50
WASTE	8
	\$12.50
TIPS	0
	\$0.00
TRAIN TTL	5
	\$62.59
BAL FORWARD	4
	\$88.13
GUESTS	5
P/BAL	4
	\$0.00
CHECKS PAID	2
	\$18.64
SERVICE	4
	\$88.13
MIX&MATCH	0
	\$0.00
PAYMENT	0
	\$0.00
OPEN CHK TTL	0
	\$0.00
AVG ITEM/CUST	7.29
AVG \$/CUST	\$10.81

GRAND	\$375.63
ETHAN	No.000209 00000

Time

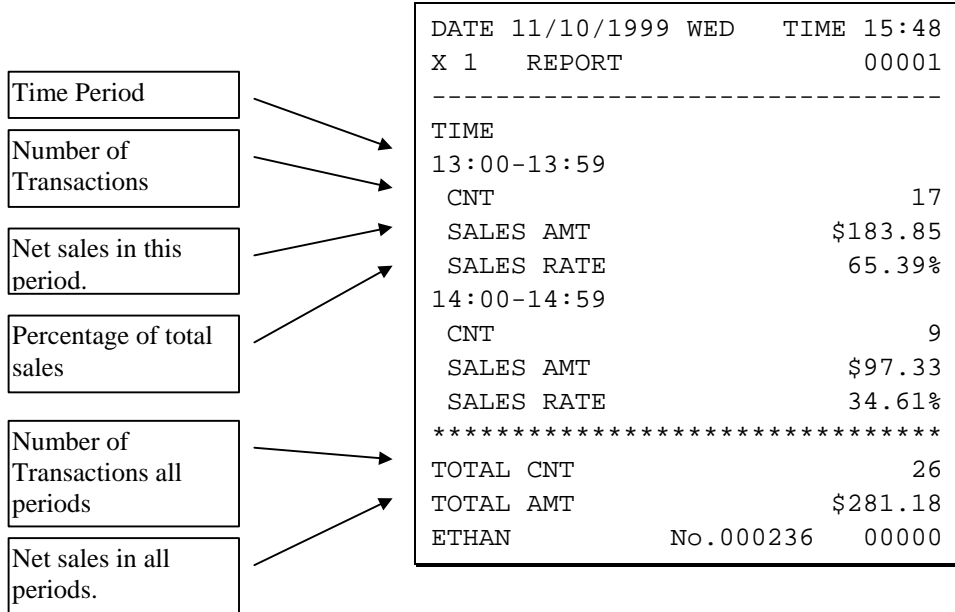

PLU

- PLU number
- PLU Descriptor
- Count and sales total.
- Percentage of total sales (optional)

```

DATE 11/10/1999 WED    TIME 15:33
X 1  REPORT              00001
-----
ALL PLU
PLU#1
HAMBURGER
  CNT 28                  $42.00
  SALES RATE              15.64%
PLU#2
DBL BURGER
  CNT 40                  $99.75
  SALES RATE              37.14%
PLU#4
COKE
  CNT 26                  $38.85
  SALES RATE              14.46%
PLU#5
SPRITE
  CNT 18                  $13.42
  SALES RATE               5.00%
PLU#7
ROAST
  CNT 19.16              $30.47
  SALES RATE              11.34%
PLU#28
UNLEADED
  CNT 32.85              $39.39
  SALES RATE              14.66%
PLU#29
RETURNS
  CNT 10                  -20.00
  SALES RATE              -7.44%
PLU#33
NAILS
  CNT 15.55              $24.72
  SALES RATE               9.20%
*****
TOTAL CNT                189.56
TOTAL AMT                $268.60
ETHAN                    No.000213  00000
  
```

- Total activity for all PLUs
- Total sales for all PLUs.

Clerk

Note: Media totals can be printed for each clerk, if selected in System Option Programming.

Clerk Name	→	DATE 11/10/1999 WED	TIME 15:36
Number of Transactions	→	X 1 REPORT	00001
Net sales for this clerk	→	-----	
Drawer total for this clerk	→	ALL CLERK	
		ETHAN	
		NET SALE	10
			\$155.23
		DRWR TTL	\$109.81

		ZACH	
		NET SALE	5
			\$45.14
		DRWR TTL	\$43.22

		ANNA	
		NET SALE	4
			\$78.75
		DRWR TTL	\$67.03

		LAURA	
		NET SALE	2
			\$0.00
		DRWR TTL	\$18.64

		PEGGY	

		MOLLY	
		NET SALE	5
			\$2.06
		DRWR TTL	-22.01

		ETHAN	No.000218 00000

Individual Clerk

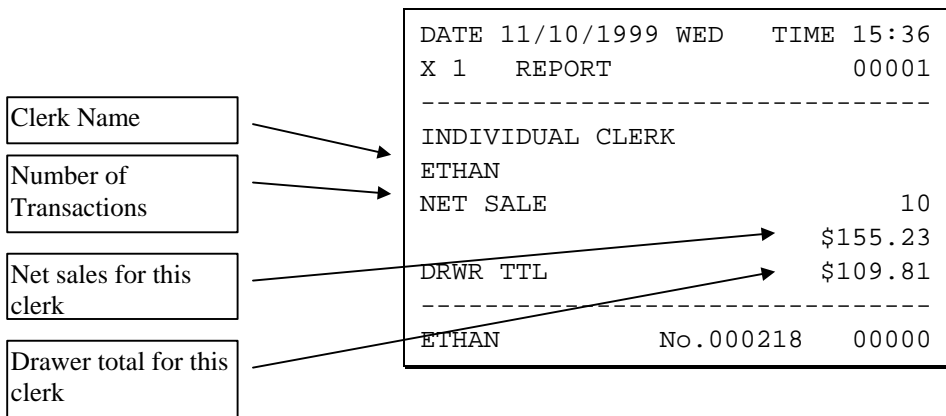

Groups

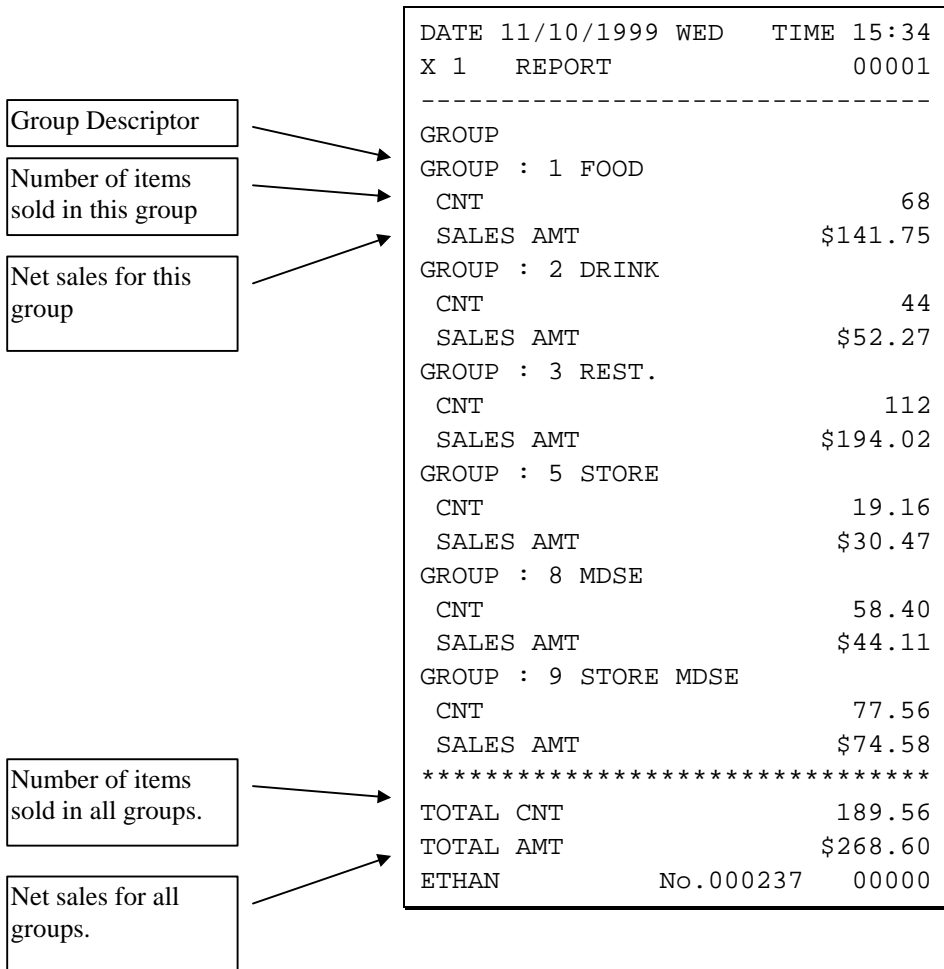

Stock

PLU number

PLU Descriptor

Current Stock count

```
DATE 11/10/1999 WED    TIME 15:47
X 1  REPORT              00001
-----
ALL PLU STOCK
PLU#1
HAMBURGER
  CNT                      26
PLU#2
DBL BURGER
  CNT                      15
PLU#7
ROAST
  CNT                      25.96
PLU#28
UNLEADED
  CNT                    1488.47
PLU#33
NAILS
  CNT                      161.25
ETHAN          No.000228    00000
DATE 11/10/1999 WED    TIME 15:47
```

Open Check

Open check number and balance.

Clerk responsible for the check.

Total of all open checks.

DATE	11/10/1999 WED	TIME	15:59
X 1	REPORT		00001

OPEN CHECK			
CHECK :	3		\$24.07
MOLLY			
CHECK :	4		\$45.42
ETHAN			
CHECK :	5		\$24.50
ETHAN			
CHECK :	6		\$28.33
ETHAN			

OPEN CHK TOTAL			122.32
ETHAN	No.000243		00000

Balancing Formulas

+/-	Net Sales	\$ Example
=	PLU Sales Total	\$
+	Tax 1	\$
+	Tax 2	\$
+	Tax 3	\$
+	Tax 4	\$
+	Sale Coupon Amounts	\$
+	Sale Percent Discounts	\$
+	Sale Surcharge Amounts	\$
=	Net Sales	\$

+/-	Gross Sales	\$ Example
=	Net Sales	\$
+	Negative PLU Total	\$
+	Item Coupon Total	\$
+	Item Percent Discount	\$
+	Sale Coupon Amounts	\$
+	Sale Percent Discounts	\$
+	Credit Tax 1	\$
+	Credit Tax 2	\$
+	Credit Tax 3	\$
+	Credit Tax 4	\$
+	Merchandise Return	\$
+	Void Position Total	\$
=	Gross Sales	\$

Integrated Payment Appendix

One Day Example of Credit Authorization

Open Batch

NOTE: To present things in a logical order, OPEN BATCH is shown at the *beginning* of the day, but in practical day-to-day operation it is recommended to open a new batch *right after* closing today's batch, so it is ready to go for the next day.

1. Turn the control lock to the **Z** position.
2. Enter **501**, press **SBTL**.
3. The message "WAITING RESP." displays momentarily, then the message "REPORT MODE" returns. No printing occurs.

Sample Transaction

1. Register a normal transaction. Press the appropriate **CHARGE** key. The message 'SLIDE CARD' displays:
2. Swipe the card. The message "SLIDE CARD." continues to displays until the card verification is complete.
3. When verification is complete, the draft is printed.

Note: If multiple documents are to be printed, the message "CLEAR / CASH" displays. Tear off the printer paper, and press CASH to resume printing.

Sample Draft

5/26/04	10:10	00001
SALE		\$2.00
*****6301		
APP: VITAL8		
REF: 41415013334		
REC NO : 1		
X _____		
I AGREE TO PAY ABOVE TOTAL AMOUNT ACCORDING TO CARD ISSUER AGREEMENT		

Sample Draft – With Gratuity

To print the tip entry line, see System Option programming and set address #26 on the ER-380M or address #29 on the ER-52XXM.

5/26/04	10:10	00001
SALE		\$2.00
*****6301		
APP: VITAL8		
REF: 41415013334		
REC NO : 1		
TIP _____		
TOTAL _____		
X _____		
I AGREE TO PAY ABOVE TOTAL AMOUNT ACCORDING TO CARD ISSUER AGREEMENT		

Manual Card Entry

1. Register a normal transaction. Press the appropriate **CHARGE** key. The message "SLIDE CARD" displays.
2. If card will not read, press **CLEAR** once, the message "ENTER ACCT NO" displays.
3. Enter the account number and press **CASH** (or press Clear twice to abort the transaction.)
4. The message "ENTER EXP DATE" displays. Enter the 4-digit expiration date and press **CASH**.
5. When verification is complete, the draft is printed.

Note: If multiple documents are to be printed, the message "CLEAR / CASH" displays. Tear off the printer paper, and press CASH to resume printing.

Merchandise Return

Complete the merchandise return transaction as you would a normal transaction. Press **MDSE RTRN** prior to entering each returned item.

1. Register a normal transaction. Press the appropriate CHARGE key. The message "SLIDE CARD" displays.
2. Swipe the card. The message "SLIDE CARD" continues to display until the card verification is complete.
3. When verification is complete, the draft is printed.

Note: If multiple documents are to be printed, the message "CLEAR / CASH" displays. Tear off the printer paper, and press CASH to resume printing.

Sample Draft

5/26/04	10:42	1
SALE		-2.00
*****6301		
APP: *7		
REF: 00003		
REC NO : 3		
X _____		
I AGREE TO PAY ABOVE TOTAL AMOUNT ACCORDING TO CARD ISSUER AGREEMENT		

Void Transaction

Transaction Void allows a transaction to be removed from the batch and not reported to the cardholder statement.

1. Turn the keylock to the VOID position.
2. Register a normal transaction.
3. Press the appropriate **CHARGE** key. The message “SLIDE CARD” displays
4. Swipe the card. The message “ENTER APP CODE” displays.
5. Enter the authorization code printed for the transaction to be voided, press CASH. . The message “ENTER REF NO” displays.

NOTE: The approval code is an alphanumeric entry. You must use the alpha code chart to determine the numeric entries. For example the approval code “VITAL8” would be entered as “086 073 084 065 076 056”.

6. Enter the Reference number from the transaction to be voided; press CASH. The transaction is found and the original record removed.

Local Total Report

Run an Issue Local Total report to confirm that credit totals match the financial report before closing the batch. See “Issue Local Total” on page 189.

Tip (Gratuity) Entry

Gratuities (tips) indicated by the customer on the payment draft must be entered into the ECR before the batch is closed.

1. Turn the key lock to the **Z** position, enter **510** and press **SUBTOTAL**.
2. At the message “ENTER REC NO.”, enter the record number of the transaction and press **CASH/TEND**.
3. At the message “ORIG TRAN AMOUNT”, enter the original transaction amount and press **CASH/TEND**.
4. At the message “TIP AMOUNT”, enter the tip amount and press **CASH/TEND**.
5. If the record number and transaction number are valid, the tip amount is entered in the batch and a tip entry chit prints as shown below.

Sample Tip Chit

```
DATE 09/27/2004 MON   TIME 10:41
SALE AMOUNT: $426
TIP AMOUNT: $1.50
REF: *
REC: 2
EMPLOYEE1   NO.000023   REG 01
```

Close Batch

NOTE: To present things in a logical order, OPEN BATCH is shown at the *beginning* of the day, but in practical day-to-day operation it is recommended to open a new batch *right after* closing today's batch, so it is ready to go for the next day.

1. Turn the control lock to the **Z** position.
2. Enter **502**, press **SBTL**.
3. The message "WAITING RESP." displays momentarily. When communication is complete, the Local Batch Status prints and the batch is closed. The message "REPORT MODE" returns.

Close Batch

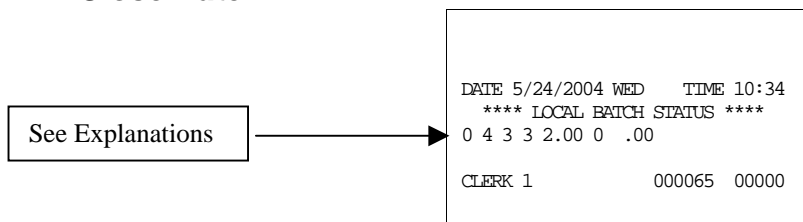

Local Batch Status Explanations:

(From Left to Right)

- o Batch Status C=Closed/O=Open
- 4 Batch Number
- 3 Batch Transaction Count
- 3 Batch Item Count
- 2.00 Batch Balance
- 0 Batch Forwarded Transaction Count
- .00 Batch Forwarded Balance

Reset Mode Procedures

DataTran Function Table

Function	Procedure
Initialize EFT	Z-Mode: Enter 500 , press SBTL
Open Batch	Z-Mode: Enter 501 , press SBTL
Close Batch	Z-Mode: Enter 502 , press SBTL
Clear Current Batch	Z-Mode: Enter 503 , press SBTL
Change Batch Number	Z-Mode: Enter 504 , press SBTL
Issue Local Total	Z-Mode: Enter 505 , press SBTL
Issue Transaction	Z-Mode: Enter 506 , press SBTL
Issue Batch Status	Z-Mode: Enter 507 , press SBTL
Dial In Load	Z-Mode: Enter 508 , press SBTL
Dial Out Load	Z-Mode: Enter 509 , press SBTL
Tip Entry	Z-Mode: Enter 510 , press SBTL
Pin Pad Initialize	Z-Mode: Enter 511 , press SBTL
Close Batch with Debit	Z-Mode: Enter 512 , press SBTL

Initialize EFT

Z-Mode: Enter **500**, press **SBTL**

Select Initialize EFT to verify communications, software versions and installed networks.

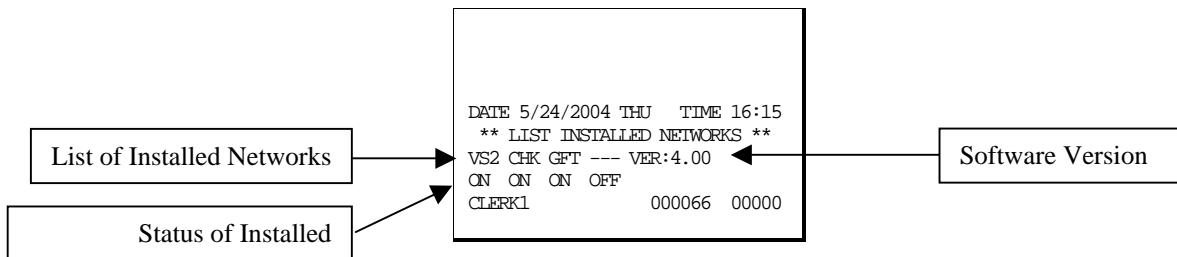

Clear Curr Batch

Z-Mode: Enter **503**, press **SBTL**

The clear batch command erases all the current batch transactions from the DataTran memory even if they have not been settled. A LOCAL TRANSACTION INQUIRY should be printed prior to clearing the batch. This will ensure that the operator has the transaction detail to re-enter if required.

This operation should only be done under the direction of DATACAP.

Chg Batch Number

Z-Mode: Enter **504**, press **SBTL**

(At the ENTER BATCH NO message, enter the new number, press **CASH**.)

The change batch number command is used to assign a new batch number to an existing batch. It is used with certain credit card processors to rectify settlement problems. It is used infrequently. (Attempt to change batch number will be denied if bank does not allow the feature.)

Issue Local Total

Z-Mode: Enter **505**, press **SBTL**

This report is added for ease of customer balancing actual totals in the Datatran to the system wide reports. A summary of each kind of credit card and a batch total should match the totals within the ER-380M/ER-5200M report before the Settle Batch is attempted.

```
DATE 5/24/2004 WED   TIME 10:55
****LOCAL  TOTAL REPORT ****
AMEX          .00 0
VISA          120.32 5
MASTER       .00 0
DISCOVER     .00 0
PRIVATE LABEL .00 0
DINERS       .00 0
JCB          .00 0
DEBIT        .00 0
TOTAL        120.32 5
CLERK 1      000069 00000
```

Issue Transaction

Z-Mode: Enter **506**, press **SBTL**

The Local Transaction Report contains details of each transaction in the current batch.

Example

(See Appendix for report key.)

```
DATE 5/24/2004 WED    TIME 10:59
*** LOCAL TRANSACTION REPORT ***
1 A 54 *****6301 0501 1 V
ITAL6 * 100.00 * * * * 4 * 052
604 113803 5 @ NY * * 00 * * D 1
00 00 * * * 00001 * * * * * 0524
04 113803 * * * * 00 *
CLERK 1                000070  00000
```

Issue Batch Status

Z-Mode: Enter **507**, press **SBTL**

The Local Batch Status Report also prints when a batch is closed.

See

```
DATE 5/24/2004 WED    TIME 10:34
**** LOCAL BATCH STATUS ****
0 4 3 3 2.00 0 .00
CLERK 1                000065  00000
```

Local Batch Status Explanations:

(From Left to Right)

- O Batch Status C=Closed/O=Open
- 4 Batch Number
- 3 Batch Transaction Count
- 3 Batch Item Count
- 2.00 Batch Balance
- 0 Batch Forwarded Transaction Count
- .00 Batch Forwarded Balance

Dial In Load/Dial Out Load

Z-Mode: Enter **508**, press **SBTL** (Dial In Load)

Z-Mode: Enter **509**, press **SBTL** (Dial Out Load)

If instructed by Datacap support, you can use these options to update DataTran software. Choose Enable Dial In Load to allow Datacap to call the DataTran and send updates. Choose Enable Dial Out Load to call Datacap to connect. You will be required to enter the phone number and terminal I.D.

Required ECR Programs

1. You must set EFT status for the port you are using. See RS-232 Communication Option Programs on page 87. Set device function to “EFT Device” and set BAUD to “2400”.
2. See System Option Programming on page 112. Set address #29 to **0** for Normal Draft with Normal Buffer Use. Add the value of **2** to your current value for a draft with a tip line.
3. See Print Option Programming on page 118. Set address #34 for the number of DataTran receipt copies you wish to print (**0-99**).
4. See CHARGE 1-8 - Function Key Options on page 130. Set option **N5** to reflect the type of payment: Credit, Debit or Gift (check with your representative for availability of gift card processing).

Local Transaction Report Key

Field	Description	Min	Max	Type
A	Transaction Sequence Number	1	5	Numeric
B	Transaction Status	1	1	Alphanumeric
C	Network Transaction Code	1	3	Alphanumeric
D	Credit Card Account Number	1	38	Alphanumeric
E	Expiration Date	4	4	Numeric
F	Card Reader Flag	1	1	Numeric
G	Approval Code	1	16	Alphanumeric
H	Reference Number	1	16	Alphanumeric
I	Transaction Amount	3	11	Numeric
J	Operator ID	1	10	Alphanumeric
K	AMEX Category or Product Code	1	10	Alphanumeric
L	Arrival Date	3	6	Numeric
M	Departure Date	3	6	Numeric
N	Gratuity Amount	3	11	Numeric
O	Media Type	1	2	Numeric
P	Special Program Code	1	1	Numeric
Q	Transaction Date	3	6	Numeric
R	Transaction Time	4	4	Numeric
S	Authorization Source Code	1	1	Numeric
T	Card Holder ID	1	1	Numeric
U	PS2000 or MIC Payment Service Indicator	1	1	Alphanumeric
V	PS2000 Transaction ID or MIC Banknet Reference Number	15 9	15 9	Alphanumeric Alphanumeric

	MIC Banknet Authorization Date	4	4	Numeric	
	MIC POS Entry Mode		1	1	Alphanumeric
	MIC Mag Stipe Error Code		1	1	Alphanumeric
W	PS2000 Validation Code	4	4	Alphanumeric	
X	Authorization Response Code		2	2	Alphanumeric
Y	PS2000 Authorization Currency Code or	3	3	Alphanumeric	
	MIC Entry Mode Change Indicator		1	1	Alphanumeric
	MIC Track Data - CVC Error		1	1	Alphanumeric
	MIC Track Data - Error Code		1	1	Alphanumeric
	ZMerchant Category Code		2	2	Alphanumeric
	AAEntry Mode		2	2	Alphanumeric
	BBOriginal Authorized Amount	3	11	Numeric	

Local Transaction Report Field Definitions

- A. Transaction Sequence Number: The DataTran will use this field to return the internal sequence number assigned to each accessed transaction.
- B. Transaction Status: The DataTran will use this field to return the current status of each accessed transaction.
Allowed values: “A” = Authorized but not captured, “C” = Captured, “F” = Forced Entry, or “V” = Void.
- C. Network Transaction Code: When available, the DataTran will use this field to return the service provider’s code assigned to each accessed transaction.
- D. Credit Card Account Number: The DataTran will use this field to return the card account number used in each accessed transaction .
- E. Expiration Date: The DataTran will use this field to return the expiration date of the credit card used in each accessed transaction.
Format: “YYMM” or “MMYY” (“YY” = year and “MM” = month).
- F. Card Reader Flag: The DataTran will use this field to return the type of account number entry used in each accessed transaction.
Allowed values: 0 = Hand entered account number, or 1 = Entered by card reader.
- G. Approval Code: The DataTran will use this field to return the approval code of each accessed transaction.
- H. Reference Number: When available, the DataTran will use this field to return the reference number of each accessed transaction.
- I. Transaction Amount: The DataTran will use this field to return the sales amount of each accessed transaction.
Format: -9999999.99 (decimal point required).
- J. Operator ID: When available, the DataTran will use this field to return the cashier or operator ID number entered in each accessed transaction.
- K. AMEX Category or Product Code: When available, the DataTran will use this field to return the American Express product or category code of each accessed transaction.
- L. Arrival Date: When available, the DataTran will use this field to return the customer’s arrival date entered in each accessed transaction.
Formats: “MMDDYY” (“MM” = month, “DD” = day, and “YY” = year).
- M. Departure Date: When available, the DataTran will use this field to return the customer’s departure date entered in each accessed transaction.
Formats: “MMDDYY” (“MM” = month, “DD” = day, and “YY” = year).
- N. Gratuity Amount: When available, the DataTran will use this field to return the gratuity amount entered in each accessed transaction.
Format: -9999999.99 (decimal point required).
- O. Media Type: The DataTran will use this field to return the media type used in each accessed transaction:
2 = American Express 6 = Private Label
3 = Visa 7 = Diner’s Club or Carte Blanche
4 = MasterCard 8 = JCB
5 = Discover 9 = Debit

- P. Special Program Code: When available, the DataTran will use this field to return the special program code entered for each accessed transaction.
- Q. Transaction Date: The DataTran will use this field to return the date of each accessed transaction.
Formats: “MMDDYY” (“MM” = month, “DD” = day, and “YY” = year).
- R. Transaction Time: The DataTran will use this field to return the time of each accessed transaction.
Format: “HHMM” (“HH” = military hours and “MM” minutes).
- S. Authorization Source Code: When available, the DataTran will use this field to return the Authorization Source Code of each accessed transaction.
- T. Card Holder ID: When available, the DataTran will use this field to return the Card Holder ID type of each accessed transaction.
- U. Payment Service Indicator: When available, the DataTran will use this field to return the Payment Service Indicator (also referred to as the ACI field) of each accessed transaction.
- V. Transaction ID: When available, the DataTran will use this field to return either the PS2000 Transaction ID number or MIC data of each accessed transaction.
- W. Validation Code: When available, the DataTran will use this field (also known as the ACI field) to return the validation code of each accessed transaction.
- X. Authorization Response Code: When available, the DataTran will use this field to return the authorization response code of each accessed transaction.
- Y. Authorization Currency Code: When available, the DataTran will use this field to return the authorization currency code of each accessed transaction.
- Z. Merchant Category Code: When available, the DataTran will use this field to return the merchant category code of each accessed transaction.
- AA. Entry Mode: When available, the DataTran will use this field to return the entry mode of each accessed transaction.
- BB. Original Authorization Amount: When available, the DataTran will use this field to return the original authorization amount of each accessed transaction.
Format: -9999999.99 (decimal point required).

Index

#

#/No Sale Key
 descriptor programs 121
 Function Key Programs 133

%

%1-%5 Keys
 Function Key Programs 143
 rate/amount programming 122

A

Add Check
 Function Key Programs 124
 Operation 38
Alpha Keyboard Overlay 103
Auto Cutter
 enable optional 111
auto-scale
 status for PLU 96

B

Balancing Formulas 176
Beeper active? 109
Break Points 92

C

Cancel 37
 Function Key Programs 124
Cash Declaration
 Operation 68
 programming 109, 111
Cash drawer

 open in training? 109
 open on reports? 109
Cash Tender 42
 Function Key Programs 125
Cash-In-Drawer Limit Programming 159
charge posting
 enabling 111
 operations 59
Charge Tender 43
 Function Key Programs 126
Check #
 Function Key Programs 129
Check Cash
 Function Key Programs 128
Check Change Limit 160
Check Endorsement
 Function Key Programs 128
Check Tender 42
 Function Key Programs 127
Clearing Memory 74
Clerk
 Descriptor Programming 148
 Drawer Assignment 148
 Programming 147
 Report 171
 Report Descriptors Programming 155
 Secret Code Programming 147
 sign on method 109
 Sign-On/Sign-Off 22
 Staydown or Popup 109
Clerk Interrupt 45
 programming 111
closed drawer, enforced 109
Compulsory non-add number
 status for PLU 96
compulsory tendering
 Cash key 125
 Charge key 126
compulsory validation
 % key 143
 add check key 124
 Cash key 125
 charge key 126
 Check Cash key 128
 Check key 127
 Drive Thru key 130
 Error Correch key 131
 Food Stamp Tender key 132
 Mdse Return key 133
 Paid Out key 135
 Recd Acct key 136
 Service key 138
 Tax exempt key 140
 Waste key 142
condiment
 compulsory status for PLU 96
 status for PLU 96
Consolidation of like items on check track 116
Control Keys 13
Control Lock 13
Currency Conversion 62

Rate program 123
Currency symbol 116

D

Date
format option 109
programming 161
Decimal place option 109
Default Program 89
Descriptor Code Chart 104
Descriptor Programming
PLU 102
direct multiplication
enable 110
Drive Thru 39
compulsory 110
Function Key Programs 130
operations 57

E

Eat-In 39
compulsory 110
Function Key Programs 130
Enforce closed drawer 109
Error Correct 33
Function Key Programs 131

F

Fast Food Drive Thru
operations 57
Financial Report 165
Descriptor Programming 153
Food Stamp
eligible status for PLU 96
Operations 63
Food Stamp Subtotal
Function Key Programs 131
Food Stamp Tender
Function Key Programs 132
Function Key
Assignment 80
Codes 81
Descriptions 17
Descriptor 121
HALO 122
Options 120
Programming 120

G

gallonage
status for PLU 96

Goods & Services Tax (GST) 90
Grand total
net or gross 117
graphic logo
print on guest check 118
print on receipt 117
user or default 118
Group
Assignment PLU 99
Programming 149
Report 173
Guest
Function Key Programs 132

H

Hard Check
operations 54
Hash
normal or non-add? 110
status for PLU 96

I

inactive
status for PLU 96
Initial Clear 16
Inventory
Stock Amount Programming 101

J

Journal
font, small or normal 117
Sample 12

K

Keyboard
ER-5200 14
ER-5240 15
Expansion 82

L

Link Programming
PLU 105

M

Machine Number Programming 163
Macro

- Key Sequence Programming 151
- name programming 157
- remove 151
- manager control
 - % key 143
 - add check key 124
 - Cancel key 124
 - Cash tendering 125
 - charge tendering 126
 - Check Cash key 128
 - Check tendering 127
 - Error Correct 131
 - Mdse Return 133
 - Modifier key 134
 - negative sales 109
 - No Sale function 133
 - P/O key 135
 - Promo key 135
 - R/A key 136
 - Scale key 137
 - Tare 139
 - Tip 141
 - Void 142
 - Waste key 142
- Memory
 - All Clear 74
 - Allocation 77
 - Clear Grand Total 75
 - Clear PLU File 75
 - Clear Totals/Counters 74
 - Clearing 74
- Merchandise Return 35
 - Function Key Programs 133
- Mix & Match Discount
 - Programming 144
 - Programming for PLU 107
- Modifier
 - Function Key Programs 134
 - Operations 29
 - staydown/popup 111
- multiple buffered receipts
 - system option 109

N

- negative
 - sale control system option 109
 - status for PLU 96
- NLU
 - Code Number Programming 158
 - Operations 24
- No Sale 46
- Non-Add Number 46

O

- Open Check Report 175
- Open drawer alarm

- programming 109
- Overlay
 - program descriptors by 111

P

- Paid Out 47
 - Function Key Programs 135
- Paper sensor
 - enable 110
- Percentage Key (%)
 - Registrations 30
- PLU
 - Auto Tare Programming 98
 - Deleting 106
 - Descriptor Programming 102
 - Group Assignment 99
 - Link Programming 105
 - Mix & Match Programming 107
 - Numeric Entries 27
 - Options - Reference Information 97
 - Price/HALO Programming 100
 - Programming 94
 - Report 170
 - Status Programming 95
 - Stock Amount Programming 101
- post tendering 44
 - system option 109
- Posting Guest Checks
 - Hard Check 54
 - Manual P/B 50
 - Soft Check 51
- preset
 - override status for PLU 96
 - status for % Key 143
 - status for PLU 96
 - tender keys (macros) 19
- Previous Balance
 - Function Key Programs 134
- Previous Item Void 34
- Price/HALO Programming 100
- Print
 - Allow a second receipt 117
 - Audaction total on the Financial report 115
 - average items per customer 117
 - average sales per customer 117
 - clerk name 115
 - clerk report with financial 115
 - consecutive number 115
 - Consolidation of like items on check track 116
 - date 115
 - date on hard check 117
 - Grand total on financial report 115
 - graphic logo on guest check 118
 - graphic logo on receipt 117
 - gross total on financial report 116
 - Kitchen Print Options 116
 - machine number 115
 - media total on clerk report 115

negative journal items in reverse print 117
percentage of sales on the PLU report 115
PLU number and descriptor 117
PLU sale item number 115
preamble/postamble 117
status for PLU 96
Subtotal 115
subtotal without tax 116
Tax amount 116
tax rate 116
tax symbol 115
taxable totals 116
time 115
training mode message 116
VAT breakdown 116
Void/Return totals on the Financial report 115
when polling reports 117
Z counter 115
zero skip on clerk 115
zero skip on financial 115
zero skip on PLU report 115
Print Check
 Function Key Programs 136
Print Option
 Programming 114
 Table 115
Priority print on KP 117
Program Scans 164
Promo
 Function Key Programs 135
 Operations 58

R

Receipt
 Message Programming 152
 On and Off 23
 Sample 11
Receipt on Request 45
Received on Account 47
 Function Key Programs 136
Report Samples
 Clerk Report 171
 Financial Report 165
 Group Report 173
 Individual Clerk 172
 Open Check Report 175
 PLU Report 170
 Stock Report 174
 Time Report 169
Report Table 71
Reports 70
reset consecutive number
 system option 109
reset grand total 109
rounding rules
 system option 110
RS-232 Communication Option Programs 83

S

Sample Journal 12
Sample Receipt 11
Scale
 Function Key Programs 137
 Operations 64
 status for PLU 96
 Tare Weight Programming 162
Self Tests 75
Service
 Function Key Programs 138
single item status for PLU 96
Soft Check
 operations 51
Split pricing
 deactivate 110
Split Tender 44
Stock
 Amount Programming 101
 Report 174
 status for PLU 96
Straight Percentage Tax Rate 90, 91
Subtotal
 Function Key Programs 138
Swedish rounding 111
System Option Programming 108
System Option Table 109

T

Table #
 Function Key Programs 139
Table Service 48
Take-Out 39
 compulsory 110
 Function Key Programs 130
Tare
 Function Key Programs 139
 Tare Weight Programming 162
Tax Exempt
 Function Key Programs 140
Tax Shift Operations 40
Tax Table Programming 92
taxable
 status for % Key 143
 status for PLU 96
Time
 programming 161
Time Report 169
Tip
 Function Key Programs 141
Training Mode 45
 enter/exit 45, 111
Transaction Void 36
Tray Subtotal
 Operation 38

U

Updating Firmware 85

V

Validate

Function Key Programs 141
tender or total? 110

Value added tax (VAT) 90

Void

Control Lock Position 36
Function Key Programs 142
volume unit 116

W

Waste

Function 58

Function Key Programs 142

Weight symbol 137

X

X lock position control *See* manager control

Z

Z counters

Reset 110

zero skip

on clerk 115

on financial 115

on PLU report 115

Manual Revision Record

Edition	Date published	Revision contents
V2.2	01/03/2006	
V2.3	01/18/2006	Starting KP # Program (Prg 1900) added
V2.4	06/02/2006	System flag #32 added