

SAM4S

SAM4s ER-5115 Electronic Cash Register

Operator's and Programming Manual



All specifications are subject to change without notice.

©2005, CRS, Inc.
M-ER5115 Version 2.0

CRS, Inc.

Limited Warranty and Disclaimers of Warranty

This manual has been developed by CRS, Inc. It is intended for the use of its customers and service personnel and should be read in its entirety before attempting to install, use or program the product(s).

Nothing contained in this manual shall be deemed to be, and this manual does not constitute, a warranty of, or representation with respect to, the product or any of the products to which this manual applies. This manual is subject to change without notice and CRS, Inc. has no obligation to provide any updates or corrections to this manual. Further, CRS, Inc. also reserves the right, without prior notice, to make changes in equipment design or components as it deems appropriate. No representation is made that this manual is complete or accurate in all respects and CRS, Inc. shall not be liable for any errors or omissions contained in this manual. In no event shall CRS, Inc. be liable for any incidental or consequential damages relating to or arising out of the use of this manual. This document contains proprietary information that is protected by copyright. All rights are reserved. No part of this document may be photocopied or reproduced without prior written consent of CRS, Inc.

NOTICE

IF ANY WARRANTY IS EXTENDED TO YOU WITH REGARD TO THE PRODUCT(S) TO WHICH THIS MANUAL APPLIES, IT IS A WARRANTY FROM THE ENTITY OR INDIVIDUAL FROM WHOM YOU DIRECTLY PURCHASED THE PRODUCT(S).

SUBJECT TO THE FOREGOING, UNLESS YOU ARE A DIRECT END USER CUSTOMER OF CRS, INC., CRS, INC. DOES NOT EXTEND TO YOU ANY EXPRESS WARRANTY OR ANY IMPLIED WARRANTY AND EXPRESSLY DISCLAIMS ANY IMPLIED WARRANTY OF MERCHANTABILITY, FITNESS FOR USE, OR FITNESS FOR ANY PARTICULAR PURPOSE, OR ANY WARRANTY OF NON-INFRINGEMENT OF INTELLECTUAL PROPERTY RIGHTS IN CONNECTION WITH THE PRODUCT(S) OR ANY SOFTWARE, DRIVERS, OR PROGRAMMING PRODUCT, WHETHER EMBEDDED IN PRODUCT(S) OR PROVIDED AS A SEPARATE PROGRAM, OR USED IN CONJUNCTION WITH THIS/THESE PRODUCT(S). CRS, INC. SPECIFICALLY DOES NOT WARRANT THAT THE OPERATION OF ANY DRIVERS, SOFTWARE, OR PROGRAMMING PRODUCTS LICENSED HEREUNDER, WHETHER EMBEDDED IN PRODUCTS OR PROVIDED AS SEPARATE PROGRAMS, SHALL BE UNINTERRUPTED OR ERROR FREE OR THAT FUNCTIONS CONTAINED IN SUCH DRIVERS, SOFTWARE OR PROGRAMMING PRODUCTS SHALL OPERATE IN COMBINATION(S) WHICH MAY BE SELECTED FOR USE BY YOU OR OTHERWISE MEET YOUR REQUIREMENTS.

CRS, Inc. is not responsible for any damages or loss, either direct, indirect, special, incidental or consequential, which you may experience as a result of your purchase or use of the product(s). Your sole remedy in the event that you encounter any difficulties with the product(s) is against the entity or individual from whom you purchased the product(s).

Revision 2.0 - April 1, 2005

WARNING - U.S.

THIS EQUIPMENT GENERATES, USES AND CAN RADIATE RADIO FREQUENCY ENERGY, AND IF NOT INSTALLED AND USED IN ACCORDANCE WITH THE INSTRUCTIONS MANUAL, MAY CAUSE INTERFERENCE TO RADIO COMMUNICATIONS. IT HAS BEEN TESTED AND FOUND TO COMPLY WITH THE LIMITS FOR A CLASS A COMPUTING DEVICE PURSUANT TO SUBPART J OF PART 15 OF FCC RULES WHICH ARE DESIGNED TO PROVIDE REASONABLE PROTECTION AGAINST SUCH INTERFERENCE WHEN OPERATED IN A COMMERCIAL ENVIRONMENT. OPERATIONS OF THE EQUIPMENT IN A RESIDENTIAL AREA IS LIKELY TO CAUSE INTERFERENCE IN WHICH CASE THE USER, AT HIS OWN EXPENSE, WILL BE REQUIRED TO TAKE WHATEVER MEASURES MAY BE REQUIRED TO CORRECT THE INTERFERENCE.

NOTICE - CANADA

THIS APPARATUS COMPLIES WITH THE CLASS "A" LIMITS FOR RADIO INTERFERENCE AS SPECIFIED IN THE CANADIAN DEPARTMENT OF COMMUNICATIONS RADIO INTERFERENCE REGULATIONS.

CET APPAREIL EST CONFORME AUX NORMES CLASS "A" D'INTERFERENCE RADIO TEL QUE SPECIFIER PAR MINISTRE CANADIEN DES COMMUNICATIONS DANS LES REGLEMENTS D'INTERFERENCE RADIO.

ATTENTION

The product that you have purchased may contain a battery that may be recyclable. At the end of its useful life, under various state and local laws, it may be illegal to dispose of the battery into the municipal waste system.



Check with your local solid waste officials for details concerning recycling options or proper disposal.

Precaution Statements

Follow these safety, servicing and ESD precautions to prevent damage and to protect against potential hazards such as electrical shock.

1-1 Safety Precautions

1. Be sure that all built-in protective devices are replaced. Restore any missing protective shields.
2. When reinstalling the chassis and its assemblies, be sure to restore all protective devices, including nonmetallic control knobs and compartment covers.
3. Make sure there are no cabinet openings through which people - particularly children - might insert fingers and contact dangerous voltages. Such openings include excessively wide cabinet ventilation slots and improperly fitted covers and drawers.
4. Design Alteration Warning:
Never alter or add to the mechanical or electrical design of the SECR. Unauthorized alterations might create a safety hazard. Also, any design changes or additions will void the manufacturer's warranty.
5. Components, parts and wiring that appear to have overheated or that are otherwise damaged should be replaced with parts that meet the original specifications. Always determine the cause of damage or over- heating, and correct any potential hazards.
6. Observe the original lead dress, especially near the following areas: sharp edges, and especially the AC and high voltage supplies. Always inspect for pinched, out-of-place, or frayed wiring. Do not change the spacing between components and the printed circuit board. Check the AC power cord for damage. Make sure that leads and components do not touch thermally hot parts.
7. Product Safety Notice:
Some electrical and mechanical parts have special safety-related characteristics that might not be obvious from visual inspection. These safety features and the protection they give might be lost if the replacement component differs from the original - even if the replacement is rated for higher voltage, wattage, etc.

Components that are critical for safety are indicated in the circuit diagram by shading, () or (). Use replacement components that have the same ratings, especially for flame resistance and dielectric strength specifications. A replacement part that does not have the same safety characteristics as the original might create shock, fire or other hazards.

CAUTION

Danger of explosion if battery is incorrectly replaced.

Replace only with the same or equivalent type recommended by the manufacturer.

Dispose used batteries according to the manufacturer's instructions.

ATTENTION

Il y a danger d'explosion s'il y a remplacement incorrect de la batterie.

Remplacer uniquement avec une batterie du même type ou d'un type équivalent recommandé par le constructeur.

Mettre au rebut les batteries usagées conformément aux instructions du fabricant.

1-2 Servicing Precautions

WARNING: First read the-Safety Precautions-section of this manual. If some unforeseen circumstance creates a conflict between the servicing and safety precautions, always follow the safety precautions.

WARNING: An electrolytic capacitor installed with the wrong polarity might explode.

1. Servicing precautions are printed on the cabinet. Follow them.
2. Always unplug the units AC power cord from the AC power source before attempting to:
 - (a) Remove or reinstall any component or assembly
 - (b) Disconnect an electrical plug or connector
 - (c) Connect a test component in parallel with an electrolytic capacitor
3. Some components are raised above the printed circuit board for safety. An insulation tube or tape is sometimes used. The internal wiring is sometimes clamped to prevent contact with thermally hot components. Reinstall all such elements to their original position.
4. After servicing, always check that the screws, components and wiring have been correctly reinstalled. Make sure that the portion around the serviced part has not been damaged.
5. Check the insulation between the blades of the AC plug and accessible conductive parts (examples : metal panels and input terminals).
6. Insulation Checking Procedure:

Disconnect the power cord from the AC source and turn the power switch ON. Connect an insulation resistance meter (500V) to the blades of AC plug.

The insulation resistance between each blade of the AC plug and accessible conductive parts (see above) should be greater than 1 megohm.
7. Never defeat any of the B+ voltage interlocks. Do not apply AC power to the unit (or any of its assemblies) unless all solid-state heat sinks are correctly installed.
8. Always connect an instrument's ground lead to the instrument chassis ground before connecting the positive lead ; always remove the instrument's ground lead last.

1-3 Precautions for Electrostatically Sensitive Devices (ESDs)

1. Some semiconductor (solid state) devices are easily damaged by static electricity. Such components are called Electrostatically Sensitive Devices (ESDs); examples include: integrated circuits and some field-effect transistors. The following techniques will reduce the occurrence of component damage caused by static electricity.
2. Immediately before handling any semiconductor components or assemblies, drain the electrostatic charge from your body by touching a known earth ground. Alternatively, wear a discharging wrist-strap device. (Be sure to remove it prior to applying power - this is an electric shock precaution.)
3. After removing an ESD-equipped assembly, place it on a conductive surface such as aluminum foil to prevent accumulation of electrostatic charge.
4. Do not use freon-propelled chemicals. These can generate electrical charges that damage ESDs.
5. Use only a grounded-tip soldering iron when soldering or unsoldering ESDs.
6. Use only an anti-static solder removal device. Many solder removal devices are not rated as anti-static; these can accumulate sufficient electrical charge to damage ESDs.
7. Do not remove a replacement ESD from its protective package until you are ready to install it. Most replacement ESDs are packaged with leads that are electrically shorted together by conductive foam, aluminum foil or other conductive materials.
8. Immediately before removing the protective material from the leads of a replacement ESD, touch the protective material to the chassis or circuit assembly into which the device will be installed.
9. Minimize body motions when handling unpackaged replacement ESDs. Motions such as brushing clothes together, or lifting a foot from a carpeted floor can generate enough static electricity to damage an ESD.

Contents

Introduction	7
About the <i>SAM4s ER-5115</i>	7
Using This Manual	8
Using Flowcharts	8
Basic Features and Functions	9
Display	10
Printer	14
Sample Receipt	14
Changing the Printer Ribbon Cartridge	16
Changing Paper	17
Control Lock	19
Keyboard	20
Operations	21
Overview	21
Function Key Descriptions	21
Clerk Sign-On/Sign-Off	25
Direct Sign-On	25
Coded Sign-On	25
Receipt On and Off	26
PLU Registrations	27
Keyboard PLU Entries	27
Keyboard PLU Level Entries	30
Numeric PLU Entries	31
Percentage Key (%) Registrations	33
Void and Correction Operations	36
Error Correct	36
Previous Item Void	37
Merchandise Return	38
VOID Control Lock Position (Transaction Void)	39
Cancel	40
Subtotal Operations	41
Subtotal	41
Tray Subtotal (Add Check)	41
Eat-In/Take-Out/Drive Thru Operations	42
Tax Shift Operations	43
Tendering Operations	45
Cash	45
Check	45
Charge	46
Split Tender	47
Post Tendering	47
Receipt on Request	48

Validation.....	48
Training Mode.....	49
Non-Add Number.....	50
No Sale.....	50
Received on Account.....	51
Paid Out.....	52
Restaurant Operations	53
Posting Guest Checks with the Previous Balance Key.....	53
Tracking Balances with the TABLE # Key.....	54
Payments	55
Optional Check Printer Sample Printout	56
Promo Function.....	57
Waste Function	57
Currency Conversion.....	58
Food Stamp Operations.....	59
Scale Operations.....	60
Direct Scale Entry	60
Manual Weight Entry.....	60
Scale With Automatic Tare Entry	61
Scale With Manual Tare Entry.....	61

Management Functions 63

Introduction.....	63
Manager Authorization Of Restricted Operations	63
Changing the Default PLU Level	64
Cash Declaration	64
System Reports.....	66
Running a Report - General Instructions.....	66
Report Table	67
Financial Report Example (Report #1)	68
Time Report Example (Report #2).....	73
All PLU Report Example (Report #3).....	74
All Clerk Report Example (Report #4)	76
Cash-In-Drawer Report Example (Report #5).....	80
Check-In-Drawer Report Example (Report #6)	80
Food Stamp-In-Drawer Report Example (Report #7)	80
Daily Sales Report Example (Report #8)	81
Item by Group Report Example (Report #10).....	82
Open Table Report Example (Report #11)	84
Inventory PLU Report Example (Report #12)	85
Group Report Example (Report #20).....	86
System Balancing	87
PLU Sales Total	87
Net Sales	87
Gross Sales.....	87
Grand Total.....	88

Programming 89

Overview	89
Default Program.....	90
Function Key Assignment Programming.....	91
Function Key Codes.....	92
Tax Programming.....	93

Straight Percentage Tax Rate Programming	94
Tax Table Programming	95
PLU Programming	97
Program 100 - PLU Status Programming.....	99
Program 150 - PLU Group Assignment	101
Program 200 - PLU Price/HALO Programming	102
Program 250 - PLU Stock Amount Programming	103
Program 300 - PLU Descriptor Programming	104
Program 400 - PLU Link Programming.....	106
System Option Programming	108
System Option Table.....	109
Function Key Programming	114
Program 70 - Function Key Options	116
Program 80 - Function Key Descriptor	117
Program 90 - Function Key HALO.....	118
#/No Sale - Function Key Programs	119
Cancel - Function Key Programs	120
Cash - Function Key Programs	121
Charge - Function Key Programs	122
Check - Function Key Programs	123
Check Cashing - Function Key Programs	124
Currency Conversion - Function Key Programs	125
Drive Thru - Function Key Programs.....	126
Eat-In - Function Key Programs	127
Error Correct - Function Key Programs	128
Food Stamp Tender - Function Key Programs.....	129
Guest # - Function Key Programs	130
Previous Balance - Function Key Programs.....	131
Promo - Function Key Programs.....	132
Paid Out - Function Key Programs	133
Received on Account - Function Key Programs	134
Return - Function Key Programs.....	135
Scale - Function Key Programs.....	136
Service - Function Key Programs	136
Table # - Function Key Programs	137
Take Out - Function Key Programs	138
Tax Exempt - Function Key Programs.....	139
Tray Subtotal - Function Key Programs.....	140
Void - Function Key Programs	141
Waste - Function Key Programs	142
% Key - Function Key Programs	143
Clerk Programming	145
Program 800 - Secret Code Programming	146
Program 801 - Drawer Assignment	146
Program 810 - Clerk Descriptor Programming	147
Miscellaneous Programming	149
Program 95 - Macro Key Sequence Programming.....	149
Receipt/Check Endorsement Message Programming.....	150
Group Status and Descriptor Programming	152
Scale Tare Weight Programming.....	154
Drawer Limit Programming	155
Machine Number Programming.....	155
Default Level Programming	156
Date and Time Programming	157
PC Schedule Operation Programming	158

Program Scans.....	159
PLU Program Scan.....	160
Tax Program Scan.....	161
Function Key Program Scan.....	162
Clerk Program Scan	163
Group Descriptor Program Scan	164
Receipt Message Program Scan	165
System Option/Default level/ Drawer Limit/Tare Scan.....	166
Key Location Program Scan	167
Macro Program Scan.....	168
Glossary of Terms	169
Index	173

Introduction

About the *SAM4s ER-5115*

Congratulations! You have selected a very flexible electronic cash register designed for years of reliable service. *SAM4s ER-5115s ECR* will fit many retail stores, shops and restaurants, providing fast transaction processing, security, and detailed sales information.

The *SAM4s ER-* features a 55-position keyboard with traditional raised keys, 5 (expandable to 15) keyboard PLU locations that will accommodate open or preset keys, and 24 programmable function key locations. The default keyboard configuration is pre-programmed with the most commonly used functions. Your *SAM4s* dealer can customize the ER-5115 for your special requirements.

Using This Manual

With this manual we hope to provide you with a means to use your *SAM4s* cash register to its fullest potential.

This manual is divided into four sections:

- "Introduction" on page 7, which explains basic features and functions.
- "Operations" on page 21, which guides the user through the basic operation sequences.
- "Management Functions" on page 60, which shows manager controlled functions, along with reports and balancing information.
- "Programming" on page 89, which provides complete programming instructions, including PLU, function key programs, and system options. This section is recommended for use by storeowners and managers, since programming can be somewhat complicated. Call your *SAM4s* dealer if you find you need programming assistance.

The *SAM4s ER-5115* allows many different configurations. This manual was written with this in mind. Although we have tried to touch on all available options, your machine may differ.

If you have questions concerning the configuration of your *ER-5115*, contact your authorized *SAM4s* dealer.

Using Flowcharts

Flowcharts are used to supplement step-by-step instructions throughout this manual. For example, the following flowchart describes how to register \$1.00 into the **PLU1** key:

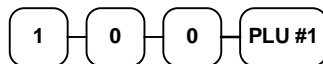

This flowchart means:

1. Press numeric key **1**.
2. Press numeric key **0**.
3. Press numeric key **0**.
4. Press **PLU #1**.

Follow the flowchart from left to right, pressing the keys in the order they are shown. Numeric keypad entries are shown as square keys. PLU and function keys are shown as rectangular keys.

Basic Features and Functions

The *SAM4s ER-5115* is designed to fit into many different retail and restaurant environments.

Standard Features Include:

- 2-station (receipt and journal) dot matrix printer, with validation slot.
- Cash drawer with 5 bill and 5 coin compartments.
- Ten position front and rear displays with a rear pop up display standard.
- 7-position control lock.
- 24-hour real-time clock with automatic day and date change.
- Four tax rates with value added tax (VAT) capability. Each tax rate is programmable for tax table look-ups and/or straight percentage tax programming. Tax rate 4 may be programmed to accommodate Canadian goods and services tax (GST).
- Operation for up to 15 clerks or cashiers with separate report totals. Your *SAM4s* dealer can provide an optional second drawer.
- 1000 Price Look Ups (PLUs) for open or preset item registration. Each keyboard PLU may be registered in one of three levels.
- 21 Group totals to accumulate totals of individual PLUs that are assigned to each group. Each PLU can be assigned to one or two different groups.
- A programmable keyboard allowing customized placement of functions as they are needed. (See "Function Key Descriptions" on page 21 for a list of available functions).
- Function keys for posting charges and payments to accounts or guest checks. You can choose manual previous balance posting or automatic balance tracking for up to 100 current balances.
- Food stamp sorting and tendering for stores that accept food stamp payments.
- Check, Cash, and up to five Charge keys.
- Management **X** and **Z** reports.
- PC Communications.

Display

The *SAM4s ER-5115* comes with a ten position front display. Annotations on the display window include:

- **PLU**, where the appropriate PLU number displays when making entries.
- **RPT**, where a counter appears when the same item is multiplied or repeated.
- The **AMOUNT** area shows the amount, i.e. price, subtotal or total.
- **RCPT OFF** indicates when the receipt is turned off.
- **VALID** illuminates once the form being inserted is aligned correctly, covering the active sensors.
- The **VOID** symbol illuminates during Void operations.
- The **SHIFT** symbol illuminates during Tax Shift operations
- The **D1** and **D2** symbols indicate whether drawer 1 or drawer 2 is selected. (The second drawer must be purchased separately.)
- The **LEVEL** symbol indicates the current PLU level.
- The **CLERK ON** segment remains illuminated as long as a clerk is signed on.

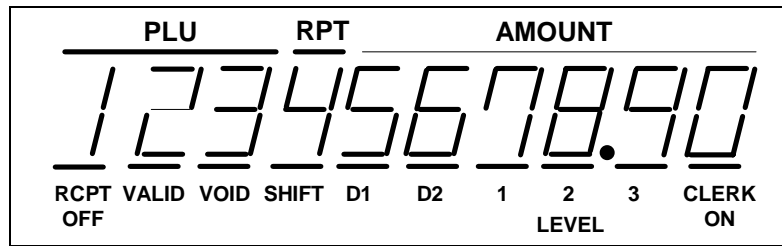

The front display offers supplemental descriptors, which appear in the first two display positions (as shown). These descriptors help the operator by supplying additional information while operating the register, and may be accompanied by an error tone.

Supplemental descriptors include:

Change Due

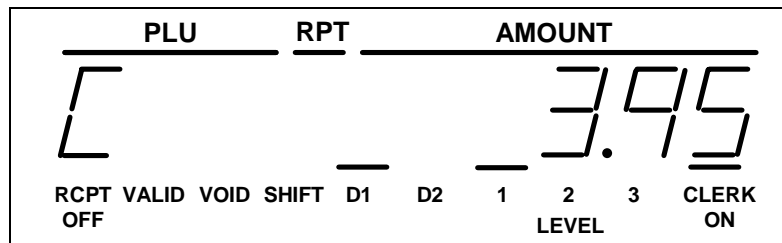

Tray Subtotal

PLU		RPT	AMOUNT						
—		—	19.95						
—		—	—						
RCPT	VALID	VOID	SHIFT	D1	D2	1	2	3	CLERK
OFF						LEVEL			ON

Negative Entry

PLU		RPT	AMOUNT						
—		—	-0.75						
—		—	—						
RCPT	VALID	VOID	SHIFT	D1	D2	1	2	3	CLERK
OFF						LEVEL			ON

Subtotal

PLU		RPT	AMOUNT						
Sub		—	12.50						
—		—	—						
RCPT	VALID	VOID	SHIFT	D1	D2	1	2	3	CLERK
OFF						LEVEL			ON

Validation Required

NOTE: The indicator light above "VALID" will illuminate once the form has been properly aligned.

PLU		RPT	AMOUNT						
SP		—	2.95						
—		—	—						
RCPT	VALID	VOID	SHIFT	D1	D2	1	2	3	CLERK
OFF						LEVEL			ON

Numbered Error Conditions

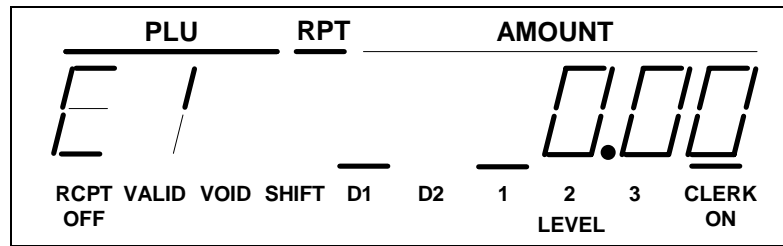

- E1** General Error (key sequence error)
- E2** Drawer Open
- E3** HALO exceeded
- E4** X mode compulsory
- E5** Compulsory Non-Add #
- E6** Require Tray Subtotal
- E7** Condiment entry required
- E8** Compulsory scale entry
- E9** Compulsory Eat-In, Take Out, or Drive Thru
- E10** Compulsory key at the start of the sale, i.e. non-add number
- E11** Cash in drawer limit exceeded
- E12** Active open drawer alarm
- E13** Guest # entry required
- E14** Scale error
- E15** Check TIP operation programming status
- E16** Clerk does not match the clerk associated with this table number
- E17** Compulsory condiment entry before item
- E18** Compulsory tare #
- E19** Close open table
- E20** Require cash declaration
- E21** Optional external printer busy
- E22** Optional external printer off line
- E23** Compulsory endorsement key
- E24** Option #48, selection of remote serial device, not set correctly
- E30** Memory capacity exceeded
- E99** Inactive function

Special Messages Displayed:

When all clerks are signed off, the display will read "CLOSEd" when the control lock is in the **REG** position.

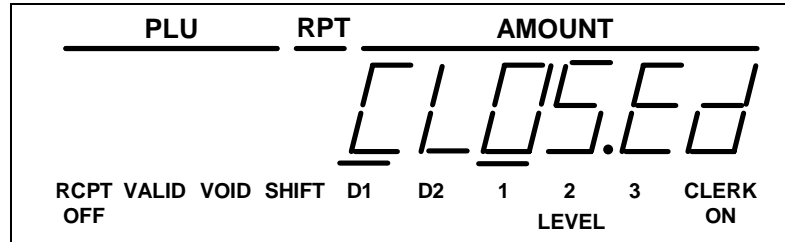

"CL" displayed while in **X** or **Z** control lock position indicates that a clerk must be signed on.

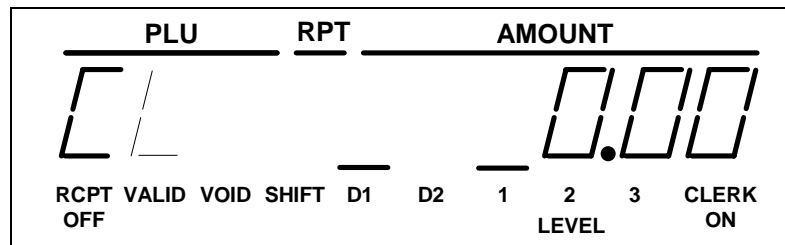

If food stamp change is due, the amount is shown on the left portion of the display. In this example, the display indicates \$2.00 in food stamp change and \$2.50 in cash change.

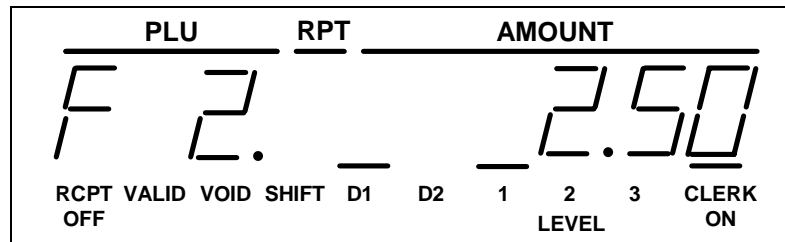

In the event of printer failure, the **PP** message will be displayed.

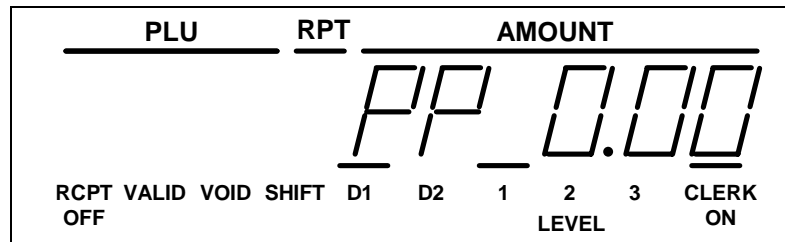

A majority of printer failures are due to paper jams, which can easily be remedied by removing both the receipt and journal tapes and clearing obstruction from the print head. Worn out and frayed printer ribbons may also jam printers. It is suggested that printer ribbons be changed as soon as print becomes faint in order to prevent frayed ribbons from causing printer failures.

Printer

Model:

- ERP-400

Features:

- Receipt and journal stations.
- Print speed: 3.0 lines per second
- Columns: 21 per station.
- Single line validation
- Character Size: 7 x 9 dots.
- Paper size: 44mm width.
- Tear off for receipt.
- Logo stamp, printing the message "Your Receipt, Thank You"

Sample Receipt

YOUR RECEIPT	Logo Stamp
THANK YOU	

THE SAM4S	4 line programmable preamble
ER-5115	message
ELECTRONIC	
CASH REGISTER	

DATE 08/15/2003 SUN	Date/Day
HAMBURGER T1 \$1.00	
TAX1 AMT \$0.06	
TOTAL \$1.06	
CASH \$1.06	
THANK YOU	2 line programmable postamble
FOR CHOOSING SAM4S	
CLERK 01 No.00001	Clerk/Consecutive #
TIME 12:00 00	Time/Register #

Two-Line Print Conditions

The *ERP-400* printer allows single line numeric fields of up to nine digits, along with programmable PLU descriptors of up to twelve characters. For this reason, provisions have been made for printing sales where the combination of descriptor and amount is greater than 21 characters.

PLU descriptors are separated from amounts by at least one blank space. If the descriptor used is a full twelve characters, and more than one tax rate is applied, all PLU entries may require two lines, with the amount on the second line.

For example:

DATE 08/15/2003	SUN
HAMBURGER T1	\$1.29
FOOD SPECIAL T1	
	\$129.95
FOOD SPECIAL T1	\$9.29
TAX1 AMT	\$8.47
TOTAL	\$149.00
CASH	\$149.00
CLERK 01	No.00001
TIME 12:00	00

two line print required
for one item

Changing the Printer Ribbon Cartridge

The *ER-5115* receipt/journal printer uses a replaceable ink ribbon cartridge. Once print becomes faint, a new ink ribbon must be installed. To replace the ink ribbon, follow these steps:

1. Remove the printer cover and locate the ink ribbon cartridge as shown in the illustration.
2. Apply downward pressure to the cartridge while pulling it towards you using the serrated area on the left edge and the raised tab near the knob on the right. Lift to remove.
3. Insert the new ink ribbon cartridge and press firmly into place. Remove any slack in the ribbon by rotating the cartridge knob counter-clockwise.

Note: Ribbon must be in place when changing paper.

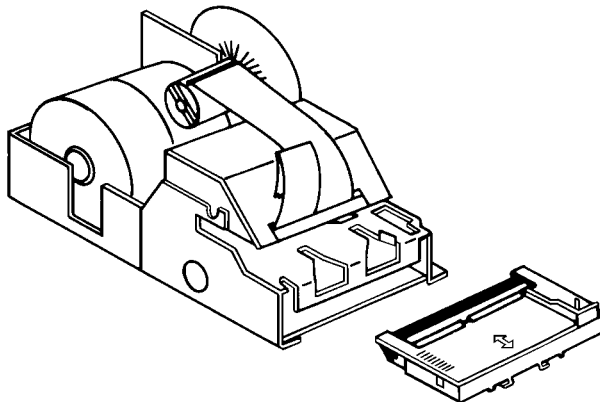

Changing Paper

Loading the Receipt Paper

1. Place the other roll of paper into the small tray on the left.
2. **Make sure the paper unrolls from the bottom of the roll.**
3. Fold back approximately 6" of paper and insert the folded end of the tape into the feed slot just in front of the paper tray at the rear of the printer.*
4. Press the **RCPT FEED** key until the paper comes through the printer. Continue to press the key until 3 - 4 inches of paper are through the printer.
5. Replace the printer cover, making sure the receipt paper comes out through the opening in the printer cover.

* **Ribbon must be in place when changing paper.**

Follow the same steps anytime you need to replace receipt or detail paper. All steps are the same. However, when replacing detail paper, cut the old detail paper at the spot where the printing stops. Then use the **DETL FEED** key to free the old paper from the printer. Remove the old detail paper from the rewind spindle.

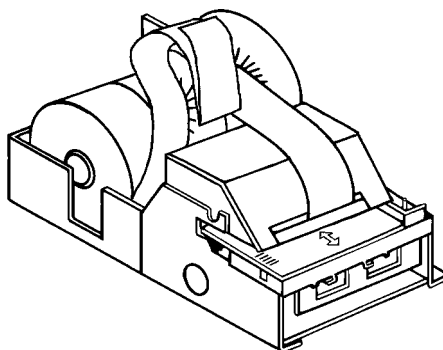

Loading of the Detail Paper

1. Place the key marked REG into the control lock and turn to the **REG** control lock position.
2. Locate the rewind spindle.
3. Locate the printer cover key. The printer cover key is the smallest key on the key ring. Insert this key into the printer cover lock. Turn the key, and remove the printer cover.
4. Locate and install the printer ribbon cartridge (see "Changing the Printer Ribbon Cartridge" on page 16).
5. As you face the keyboard, notice two plastic trays behind the printer mechanism. Place one of the rolls of printer paper into the tray on the right. **Make sure the paper will unwind from the bottom of the roll.**
6. Fold back approximately 6" of paper and insert the folded end of the tape into the feed slot just in front of the paper tray at the rear of the printer.*
7. Press the **DETL FEED** key on the cash register keyboard until the edge of the paper feeds through the printer. Run 6 - 8 inches of paper through the printer.
8. Insert the end of the paper into the slot on the shaft of the rewind spindle, holding the spindle with the gear to the right and the shaft to the left. Wind the spindle several turns to be sure the paper will stay on the spindle. Press the end piece of the rewind spindle back onto the left end of the shaft.
9. Slide the axle of the rewind spindle (between the gear and the shaft) into the notch of the printer housing. **Make sure the gear on the rewind spindle meshes with the gear on the printer.**
10. Press the **DETL FEED** key several more times to make sure the paper moves properly through the printer.

*** Ribbon must be in place when changing paper.**

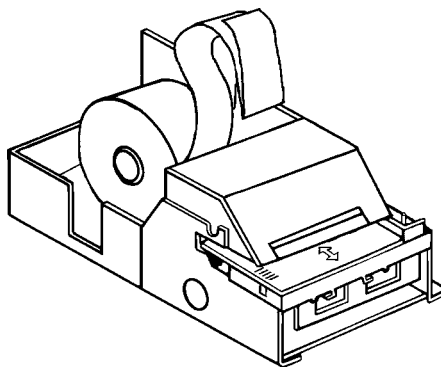

Control Lock

The control lock has 7 positions, accessed with 5 keys. Each ECR is shipped with two full sets of keys.

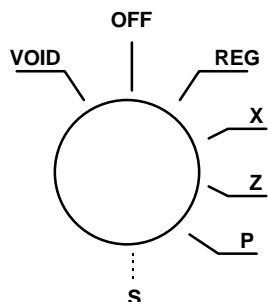

- VOID** Use to void (correct) items outside of a sale.
- OFF** The register is inoperable.
- REG** Use for normal registrations.
- X** Use to read register reports.
- Z** Use to read register reports and reset totals to zero.
- P** Use to program the register.
- S** The S position is a hidden position reserved for dealer access.

All normal operations are performed with the control lock in the **REG** position. Refer "Manager Authorization Of Restricted Operations" on page 63 to perform operations in the **X** position.

Before performing any operations in Register Mode a clerk must be signed on. See "Clerk Sign-On/Sign-Off" on page 25 for a description of clerk operations.

Control Keys

The *SAM4s ER-5115* includes two sets of keys that may be used to access the following control lock positions.

<u>Key</u>	<u>Positions Accessible</u>
REG	OFF, REG
VOID	VOID, OFF, REG, X
Z	VOID, OFF, REG, X, Z
P	VOID, OFF, REG, X, Z, P
C	ALL POSITIONS

Note: Keys may be removed from the control lock in the OFF or REG positions.

Keyboard

ER-5115 Keyboard - Default

The ER-5115 keyboard is shown below with the default legends and key assignments. This configuration has 5 keyboard PLU locations.

Programmable key locations are shown with a bold border with the location number in the lower left.

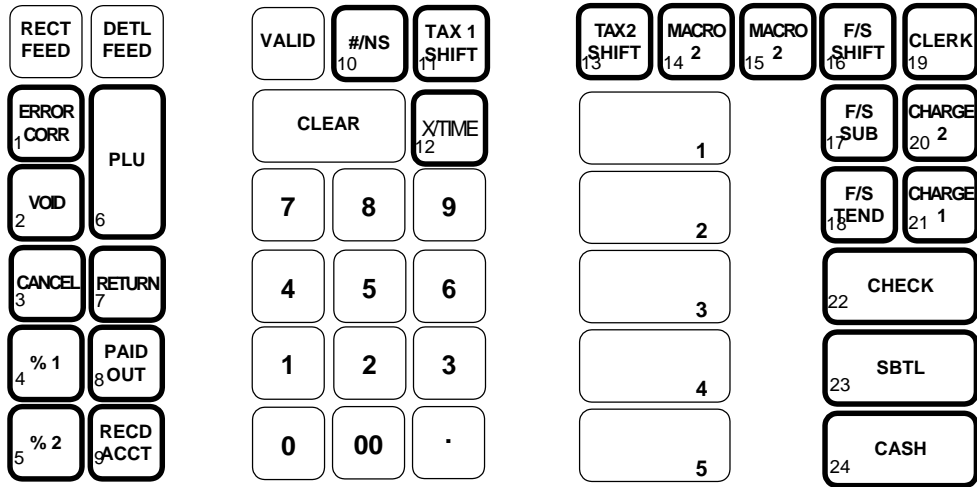

ER-5115 Keyboard - Expanded

The ER-5115 keyboard is shown below with the default legends and key assignments. This configuration has 15 keyboard PLU locations.

Programmable key locations are shown with a bold border with the location number in the lower left.

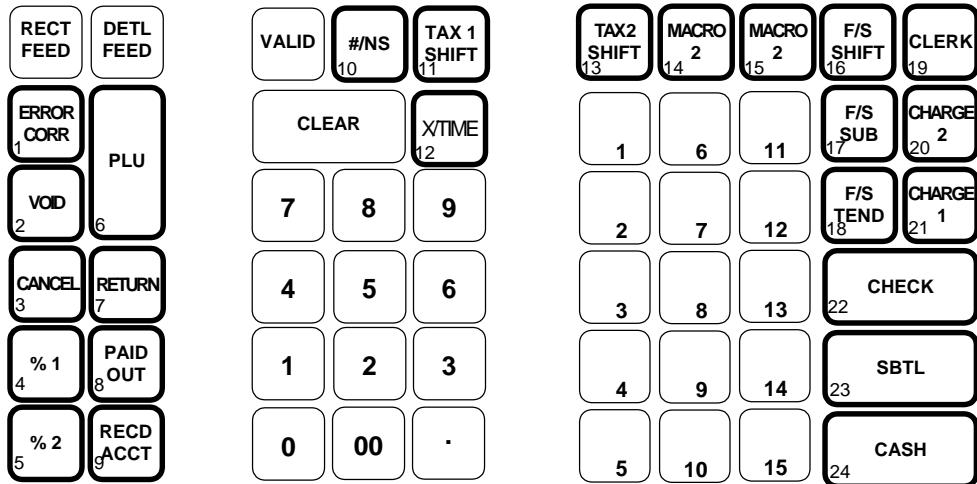

Operations

Overview

The operations section of this manual gives basic information about the functions performed by the register. Each of the function keys is explained, giving a general description of their operation.

Example operations are given for each function key showing correct keystrokes and the resulting print on the receipt. Since all machines differ in actual programming, the operation of some keys may require a management key, while other optional keys may not exist on your keyboard.

If you have questions concerning your keyboard set-up, please contact your authorized *SAM4s* dealer.

Function Key Descriptions

Keys are listed in alphabetical order. Some of the keys described below are not included on the default keyboard. See "Function Key Assignment Programming" on page 91 to add or change programmable keys.

Keyboard Legend	Description
#/NS	Use as a non-add key to print up to an 8-digit numeric entry on the receipt and journal. This entry will not add to any sales totals. The #/NS key is also used to open the cash drawer without making a sale.
X/TIME	Use to multiply a quantity of items or calculate split pricing on PLU entries.
00, 0-9, Decimal	Use to make numeric entries in REG, X, Z, VOID, or P positions. The decimal key is used for decimal or scale multiplication, when setting or entering fractional percentage discounts, or when programming fractional tax rates. Do not use the decimal key when making amount entries into PLUs.
CANCEL	Cancels a transaction without updating PLU, or function key totals. The Cancel function may only be used prior to tendering. Once tendering begins, the Cancel function may no longer be used. The CANCEL key corrects the appropriate totals and counters and the Financial report records total of transactions canceled.

Keyboard Legend	Description
CASH	<p>Calculates the sale total including tax, finalizes the sale, and opens the cash drawer. Change computation is allowed by entering an amount before pressing the CASH key. The cash drawer will open only if the amount tendered is equal to or greater than the total amount of the sale. Post tendering is also available should a second change calculation be necessary. Re-enter the tendered amount and press the CASH key to show the new change computation.</p> <p>Press the CASH key a second time to issue a buffered receipt (up to 200 lines) when the receipt on/off function is OFF.</p>
CHECK	<p>Use to finalize check sales. Calculates the sale total including tax, finalizes the sale, and opens the cash drawer. Change computation is allowed by entering an amount before pressing the CHECK key. The cash drawer will open only if the amount tendered is equal to or greater than the total amount of the sale. Change issued will be subtracted from the cash-in-drawer total.</p>
CHECK CASHING	<p>Use to exchange a check for cash. Cash-in-drawer and check-in-drawer totals are adjusted.</p>
CHECK ENDORSEMENT	<p>Use to print a check endorsement message on an optional slip printer. See "Receipt/Check Endorsement Message Programming" on page 150 to program an endorsement message.</p>
CHARGE(1-5)	<p>Use to finalize charge sales. Calculates the sale total including tax, finalizes the sale, and opens the cash drawer. Change computation is allowed by entering an amount before pressing the CHARGE key. The cash drawer will open only if the amount tendered is equal to or greater than the total amount of the sale. Change issued will be subtracted from the cash-in-drawer total.</p>
CLEAR	<p>Use to clear entries made into the 10 key numeric pad or X/TIME key before they are printed. Also used to clear error conditions.</p>
CLERK	<p>The register will not operate in register mode unless a clerk has been signed on. Direct or secret code sign accomplishes clerk sign-on on.</p> <p>All entries made on the register will report to one of the 15 clerk totals. When a clerk is signed on, all entries following will add to that clerk's total until another clerk is signed on. However, a clerk cannot be changed in the middle of a transaction.</p> <p>To sign a clerk off, thereby displaying the "CLOSEd" message on the display, enter 0 (zero), then press the CLERK key. This disables the register until another clerk is signed on. The current clerk must first be signed off before another clerk may be signed on.</p>
CONV (1 & 2)	<p>The currency conversion function, allowed after subtotal, converts and displays the new subtotal at a preprogrammed exchange rate. Tendering is allowed after using the currency conversion function. Change is calculated and issued in home currency. The amount of foreign currency tendered is stored in a separate total on the Financial report, but not added to the drawer total.</p>
DETL FEED	<p>Advances the detail paper one line, or continuously until the key is released.</p>

Keyboard Legend	Description
EAT-IN TAKE OUT DRIVE THRU	<p>Eat-In, Take Out and Drive Thru are subtotal functions. In areas that have different tax rules for eat-in and take out sales, the EAT-IN, TAKE OUT and DRIVE THRU keys can be programmed to automatically charge or exempt taxes.</p> <p>Sales may not be split between Eat-In, Take Out and Drive Thru.</p> <p>The EAT-IN, TAKE OUT and DRIVE THRU keys maintain separate totals on the Financial report.</p>
ERROR CORR	Use to correct the last entry. The ERROR CORR key corrects the appropriate totals and counters.
F/S SHIFT	When pressed before a PLU entry, the F/S SHIFT key reverses the preprogrammed food stamp status of the PLU. For example, an item not food stamp eligible can be made food stamp eligible.
F/S SUB	Displays the amount of the sale that is food stamp eligible.
F/S TEND	Use to tender food stamps for eligible sales.
GUEST #	Use to enter the count of guests served as part of a guest check.
LEVEL (1-3)	Level keys shift the keyboard PLU that is being registered. Levels can be <i>stay down</i> to accommodate, for example, breakfast, lunch and dinner menus; <i>pop-up after each item</i> to register, for example large, medium or small soft drink; <i>pop-up after each transaction</i> to register, for example, toppings of various pizza sizes.
MACRO (1-5)	Macro keys may be programmed to record, then later perform, up to 50 keystrokes. For example, a macro key could be set to tender (preset tender) a common currency, such as \$5 into the cash key.
P/BAL	Use to enter the amount of an outstanding balance.
PAID OUT	Use to record money taken from the register to pay invoices, etc. The paid out amount subtracts from the cash-in-drawer total. Paid outs are allowed outside of a sale only.
% Keys	<p>Up to five % keys may be placed on the keyboard. Each % key is set with a specific function, such as item discount or surcharge, or sale discount or surcharge. The percent rate may be entered or preprogrammed, or the percent keys can be programmed with a negative open or preset price, thus acting as coupon keys.</p> <p>A percentage key may also be set up to accept charge tip entries.</p>
PLU	The PLU key is used to register price look-ups by number entry. PLUs can be programmed open or preset, and positive or negative.
Keyboard PLU Keys	Use to categorize merchandise (as you would with traditional department keys.) Keyboard PLUs can be programmed open or preset, and positive or negative.
PROMO	The PROMO key allows you to account for promotional items, as in "buy two, get one free". Pressing this key will remove an item's cost from the sale, but will include the sale of the item in the item's sales counter.
RCPT FEED	Advances the receipt paper one line, or continuously until the key is released.
RECEIPT ON/OFF	When 'OFF' no receipt will print during a sale. (If the receipt is off, a buffered receipt is available by pressing the CASH key a second time.)

Keyboard Legend	Description
RECD ACCT	The RECD ACCT (received on account) key is used to record media loaned to the cash drawer, or payments received outside of a sale. The cash drawer will open. The amount received adds to the cash-in-drawer total.
RETURN	Used to return or refund merchandise. Returning an item will also return any tax, which may have been applied.
SCALE	Use to make weight entries. When a scale is attached, press the scale key to show the weight in the display, then press (or enter) a PLU to multiple the weight times the price. When a scale is not attached, you can enter the weight (using the decimal key for fractions). PLUs may be programmed to require an entry through the scale key.
SERVICE	Use to temporarily finalize Previous Balance or Table tracking transactions.
SBTL	Displays subtotal of sale including tax. Must be pressed prior to a sale discount or sale surcharge.
TABLE #	Tracks the current balance for a guest check or table.
TAX EXEMPT	Press the TAX EXEMPT key to exempt tax 1, tax 2, tax 3, and/or tax 4 from the entire sale.
TAX (1-4) SHIFT	When pressed before a PLU entry, the tax shift keys reverse the tax status of the PLU, i.e., a PLU with non-tax status would become taxable or a PLU with tax status would become non-taxable.
TRAY SUBTOTAL	Use to combine individual trays (in a cafeteria situation) that will be paid together. Each tray subtotal entry will advance the consecutive number.
VOID	Use to correct an item entered earlier within a sale. The VOID key corrects the appropriate totals and counters. To correct the last item, use the ERROR CORR key. For void operations outside of a sale (Transaction Void), use the VOID position on the control lock. The Financial report records totals for each type of void separately.
VALID	Press the VALID key to print a one-line validation on a separate form or piece of paper. Any item registration, discount or payment may be validated. If validation is required after a particular function, the message " SP " will appear on the front display.
WASTE	The WASTE key allows control of inventory by accounting for items that must be removed from stock due to spoilage, breakage or mistakes. Press the WASTE key before entering wasted items, then press the WASTE key again to finalize. The WASTE key may be under manager control, requiring the control lock to be in the X position. The WASTE key is not allowed within a sale.

Clerk Sign-On/Sign-Off

See "System Option Programming" on page 108, to review your clerk options:

- The ER-5115 can be set to function with a cashier or clerk reporting system. System option #7 allows you to select media reporting, thus allowing cashier accountability.
- System option #15 allows you to select direct or code entry sign on and/or stay-down or pop-up operation.

Depending on how your machine has been programmed, sign-on will take place only at the beginning of a shift (stay-down), or may have to be repeated for each transaction (pop-up). If your machine has been programmed for stay-down clerks, the clerk currently signed on must be signed off before another clerk may be signed on.

Check with your store manager to see which options have been selected for your register.

Before any transaction may take place, a clerk must be signed on. Clerk sign-on is accomplished in one of two ways:

Direct Sign-On

To sign on a clerk, enter the clerk number and press the clerk key.

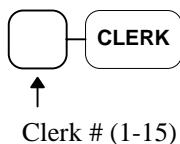

To sign the clerk off, enter 0 (Zero) and press the clerk key.

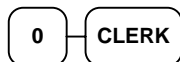

Coded Sign-On

To sign on a clerk, press the clerk key, enter the clerk code, and then press the clerk key again.

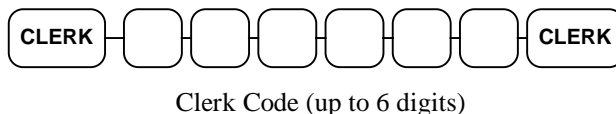

To sign the clerk off, enter 0 (Zero) and press the clerk key.

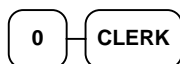

Receipt On and Off

The **RECEIPT ON/OFF** function key may or may not be located on your keyboard. (The **RECEIPT ON/OFF** key is not included on the default keyboard.)

If The RECEIPT ON/OFF Key Is Located On The Keyboard

1. Press the **RECEIPT ON/OFF** key once to turn the receipt *off*.
2. Press the **RECEIPT ON/OFF** key again to turn the receipt *on*.

If The RECEIPT ON/OFF Key Is Not Located On The Keyboard

1. Turn the control lock to the **X** position.
2. To turn the receipt *off*, enter **9 9**, press the **SBTL** key. Enter **1**, press **CASH**.



3. To turn the receipt *on*, enter **9 9**, press the **SBTL** key. Enter **0**, press **CASH**.



PLU Registrations

All registrations on the *SAM4s ER-5115* are made into open or preset PLUs.

- In place of traditional department keys, some PLUs are located directly on the keyboard.
- When more items or categories are needed than the number of PLUs available on the keyboard, registrations can be into PLUs by entering the PLU code number and pressing the **PLU** key on the keyboard.

This system simplifies reporting by listing all items (regardless of how they are entered) on the PLU report, while reporting for groups of items or categories is available from the Group report.

Keyboard PLU Entries

As you make PLU registrations, you can follow your entries by viewing the display. The digits marked **PLU** indicate the PLU number being used. The digit marked **RPT** counts items as they are repeated or multiplied.

In the following examples:

- PLU 1 is programmed for open entries, and is taxable by Tax 1.
- PLU 2 is programmed for open entries, and is taxable by Tax 2.
- PLU 3 is programmed with a preset price of \$3.00, and is taxable by Tax 1 and Tax 2.
- PLU 4 is programmed with a preset price of \$4.00, and is non-taxable.
- PLU 1 level 2 (PLU 118) is programmed with a preset price of \$1.25, and is taxable by Tax 1.
- Tax 1 is programmed at 5%; Tax 2 is programmed at 10%.

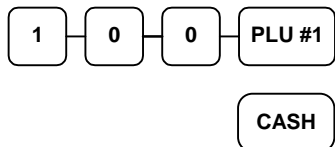

```

DATE 08/15/2003  SUN
PLU 1 T1          $1.00
TAX1 AMT         $0.05
TOTAL            $1.05
C A S H         $1.05
CLERK 01         No.00001
TIME 12:00       00
  
```

Open Keyboard PLU Entry

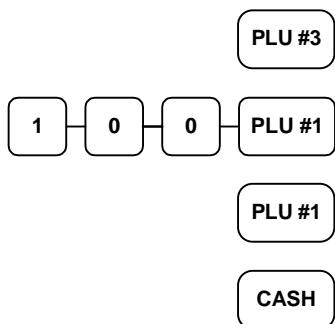

```

DATE 08/15/2003  SUN
PLU 3 T12        $3.00
PLU 1 T1          $1.00
PLU 1 T1          $1.00
TAX1 AMT         $0.25
TAX2 AMT         $0.30
TOTAL            $5.55
C A S H         $5.55
CLERK 01         No.00001
TIME 12:00       00
  
```

Single Preset PLU

Single Open PLU

Repeat PLU Item

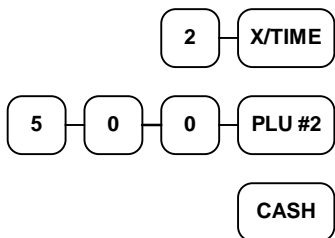

```

DATE 08/15/2003  SUN
2X               @5.00
PLU 2 T2         $10.00
TAX2 AMT         $1.00
TOTAL            $11.00
C A S H         $11.00
CLERK 01         No.00001
TIME 12:00       00
  
```

Multiple Quantity of a PLU Entry

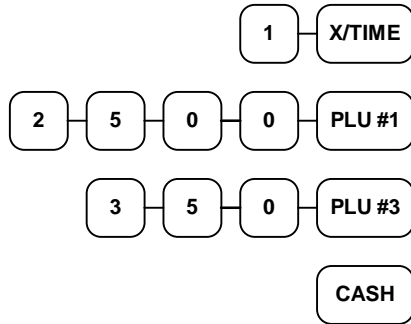

```

DATE 08/15/2003  SUN
1X          @25.00
PLU 1 T1    $25.00
PLU 3 T12   $3.50
TAX1 AMT    $1.43
TAX2 AMT    $0.35
TOTAL       $30.28
C A S H    $30.28
CLERK 01    No.00001
TIME 12:00      00
  
```

HALO Override on PLU Entry

Preset Override of a Keyboard PLU

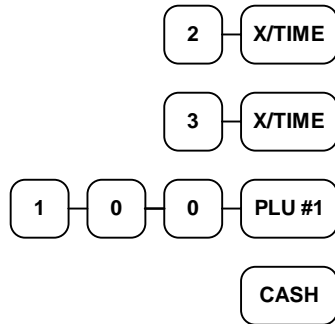

```

DATE 08/15/2003  SUN
2/3FOR      @1.00
PLU 1 T1    $0.67
TAX1 AMT    $0.03
TOTAL       $0.70
C A S H    $0.70
CLERK 01    No.00001
TIME 12:00      00
  
```

Split Pricing PLU Entry

Keyboard PLU Level Entries

Three keyboard levels are provided on the *SAM4s ER-5115*. Depending upon how your cash register is set up, (see "System Option Programming" on page 108) levels can be operated as stay-down, pop-up, or ticket pop-up.

- Stay-down levels allow you to shift the level of the entire keyboard simultaneously. For example, a restaurant may have breakfast, lunch and dinner menus. You can shift menus by shifting the level of the keyboard and changing the key legend sheet over the keyboard.
- Pop-up levels allow you to momentarily shift the level of the keyboard for the next item. For example, soft drinks may be sold in three sizes. With the level keys labeled as sizes, you can register soft drinks by pressing **LEVEL 1** for small, **LEVEL 2** for medium or **LEVEL 3** for large, then pressing the PLU representing the appropriate type of soft drink.
- Ticket pop-up levels allow you to shift the level of the keyboard for the next registration. For example, pizzas may be sold with multiple toppings, with the price of additional toppings depending on the size of the pizza. By first selecting a level representing the size of the pizza, the operator can then press any number of PLU keys representing toppings, with the appropriate topping price category locked in.

1 0 0 PLU #1

LEVEL 2 PLU #1

1 0 0 PLU #1

CASH

DATE 08/15/2003	SUN
PLU 1 T1	\$1.00
PLU 16 T1	\$1.25
PLU 1 T1	\$1.00
TAX1 AMT	\$0.16
TOTAL	\$3.41
C A S H	\$3.41
CLERK 01	No.00001
TIME 12:00	00

**Level Shift Entry
(Pop-up levels)**

Numeric PLU Entries

In the following examples:

- PLU 510 is programmed open, and is taxable by Tax 1.
- PLU 520 is programmed open, and is taxable by Tax 2.
- PLU 530 is programmed with a preset price of \$1.50, and is taxable by Tax 1 and Tax 2.
- PLU 540 is programmed with a preset price of \$2.50, and is non-taxable.

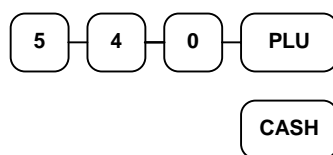

DATE	08/15/2003	SUN
PLU 540	\$2.50	
TOTAL	\$2.50	
C A S H	\$2.50	
CLERK 01	No.00001	
TIME 12:00	00	

Preset PLU Entry

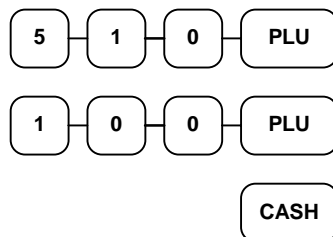

DATE	08/15/2003	SUN
PLU 510 T1	\$1.00	
TAX1 AMT	\$0.05	
TOTAL	\$1.05	
C A S H	\$1.05	
CLERK 01	No.00001	
TIME 12:00	00	

Single Open PLU Entry

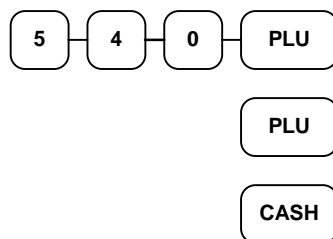

DATE	08/15/2003	SUN
PLU 540	\$2.50	
PLU 540	\$2.50	
TOTAL	\$5.00	
C A S H	\$5.00	
CLERK 01	No.00001	
TIME 12:00	00	

Single Preset PLU Entry

Repeat Entry

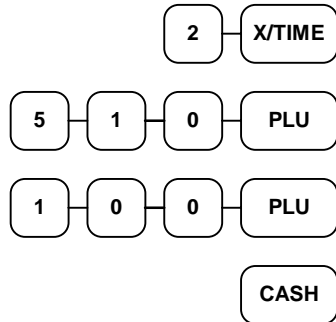

```

DATE 08/15/2003  SUN
2X          @1.00
PLU 510 T1  $2.00
TAX1 AMT    $0.10
TOTAL       $2.10
C A S H    $2.10
CLERK 01    No.00001
TIME 12:00      00
  
```

Multiple Quantity of a Open PLU Entry

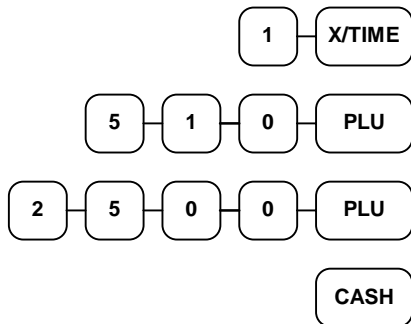

```

DATE 08/15/2003  SUN
1X          @25.00
PLU 510 T1  $25.00
TAX1 AMT    $1.25
TOTAL       $26.25
C A S H    $26.25
CLERK 01    No.00001
TIME 12:00      00
  
```

HALO Override on PLU Entry

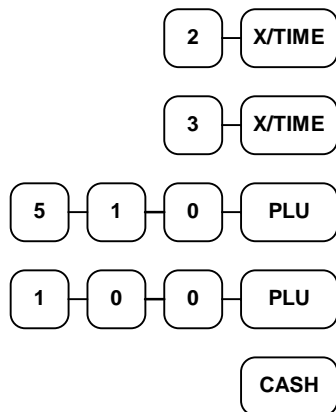

```

DATE 08/15/2003  SUN
2/3FOR     @1.00
PLU 510 T1  $0.67
TAX1 AMT    $0.03
TOTAL       $0.70
C A S H    $0.70
CLERK 01    No.00001
TIME 12:00      00
  
```

Split Pricing PLU Entry

Percentage Key (%) Registrations

There are two percentage keys, %1 and %2, on the default keyboard. Through "Function Key Assignment Programming" (see page 91) up to five percentage keys may be placed on the keyboard. Each key is individually programmable to add or subtract, from an individual item or from a sale total, amounts (coupons) or percentages. You can also program the percentage key taxable or non-taxable, so that sales taxes are calculated on the net, or gross amount of the item or sale.

The operation examples in this section show the percentage key in a variety of configurations. See "Function Key Programming" on page 109 to assign a specific function to each percentage key.

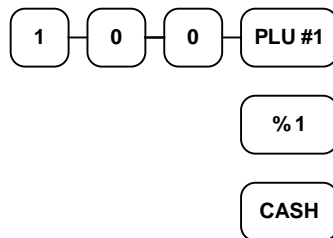

DATE	08/15/2003	SUN
PLU 1 T1		\$1.00
SURCHARGE 1	10.000%	
AMOUNT T1		\$0.10
TAX1 AMT		\$0.06
TOTAL		\$1.16
C A S H		\$1.16
CLERK 01	No.00001	
TIME 12:00		00

***Preset 10%
Surcharge on an
Item***

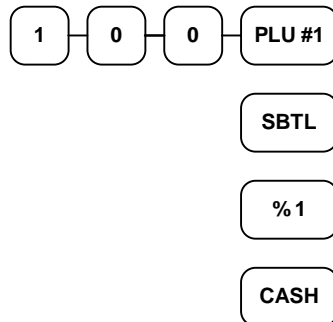

DATE	08/15/2003	SUN
PLU 1 T1		\$1.00
SURCHARGE 1	-10.000%	
AMOUNT T1		-0.10
TAX1 AMT		\$0.05
TOTAL		\$0.95
C A S H		\$0.95
CLERK 01	No.00001	
TIME 12:00		00

***Preset 10% Discount
on a Sale***

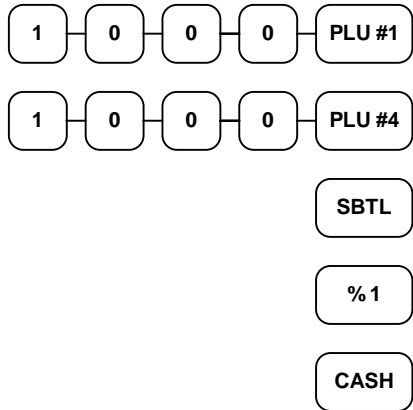

DATE	08/15/2003	SUN
PLU 1 T1	\$10.00	
PLU 4	\$10.00	
SALE SURC 1	10.00%	
AMOUNT T1	2.00	
TAX1 AMT	\$0.55	
TOTAL	\$22.55	
C A S H	\$22.55	
CLERK 01	No.00001	
TIME 12:00	00	

**Preset 10%
Surcharge on a Sale**

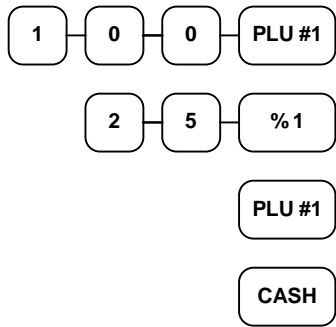

DATE	08/15/2003	SUN
PLU 1 T1	\$1.00	
PLU 1 T1-C	-0.25	
TAX1 AMT	\$0.04	
TOTAL	\$0.79	
C A S H	\$0.79	
CLERK 01	No.00001	
TIME 12:00	00	

**Store Coupon Entry
(Open Amount
Discount on an Item)**

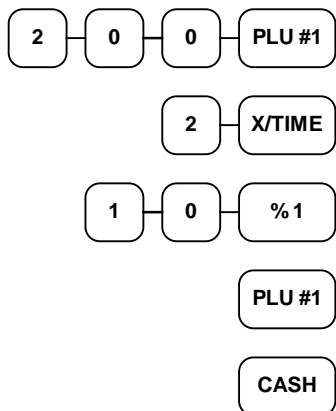

DATE	08/15/2003	SUN
PLU 1 T1	\$2.00	
2X	@0.10	
PLU 1 T1-C	-0.20	
TAX1 AMT	\$0.09	
TOTAL	\$1.89	
C A S H	\$1.89	
CLERK 01	No.00001	
TIME 12:00	00	

**Multiple Store
Coupon Entry
(Open Amount
Discount on an Item)**

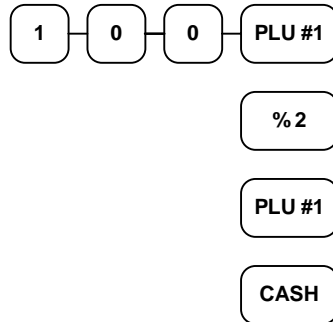

```

DATE 08/15/2003  SUN
PLU 1 T1          $1.00
PLU 1 T1-C       -0.50
TAX1 AMT         $0.03
TOTAL            $0.53
C A S H         $0.53
CLERK 01         No.00001
TIME 12:00      00
  
```

***Preset Store Coupon
(Preset Amount
Discount on an Item)***

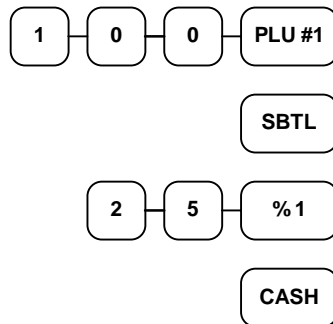

```

DATE 08/15/2003  SUN
PLU 1 T1          $1.00
VCPN AMT T1      -0.25
TAX1 AMT         $0.04
TOTAL            $0.79
C A S H         $0.79
CLERK 01         No.00001
TIME 12:00      00
  
```

***Vendor Coupon
Entry
(Open Amount
Discount on a Sale)***

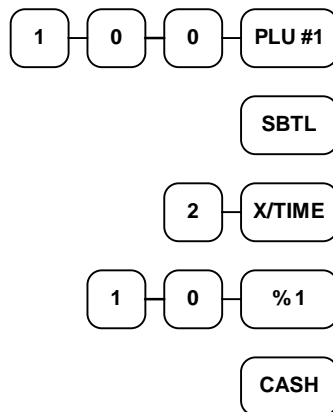

```

DATE 08/15/2003  SUN
PLU 1 T1          $1.00
2X               @0.10
VCPN AMT T1      -0.20
TAX1 AMT         $0.04
TOTAL            $0.84
C A S H         $0.84
CLERK 01         No.00001
TIME 12:00      00
  
```

***Multiple Vendor
Coupon Entry
(Open Amount
Discount on a Sale)***

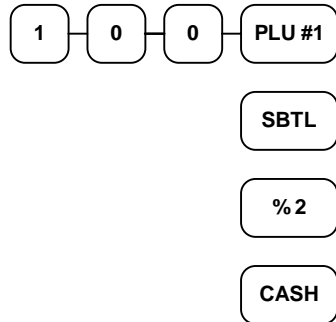

DATE 08/15/2003	SUN
PLU 1 T1	\$1.00
VCPN AMT T1	-0.50
TAX1 AMT	\$0.03
TOTAL	\$0.53
C A S H	\$0.53
CLERK 01	No.00001
TIME 12:00	00

**Preset Vendor
Coupon Entry
(Preset Amount
Discount on a Sale)**

Void and Correction Operations

Error Correct

The error correct function voids the last item entered, provided no other key has been pressed.

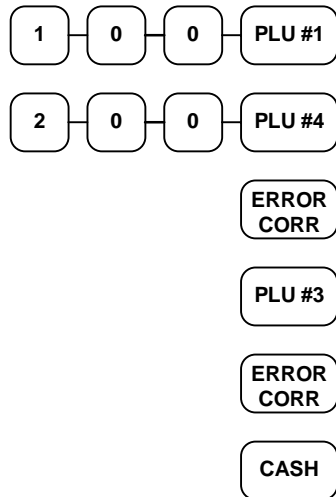

DATE 08/15/2003	SUN
PLU 1 T1	\$1.00
PLU 4	\$2.00
ERRCORR -----	
PLU 4	-2.00
PLU 3 T12	\$3.00
ERRCORR -----	
PLU 3 T12	-3.00
TAX1 AMT	\$0.05
TOTAL	\$1.05
C A S H	\$1.05
CLERK 01	No.00001
TIME 12:00	00

Error Correction

Previous Item Void

The previous item void function allows the correction of any item previously entered in the current transaction.

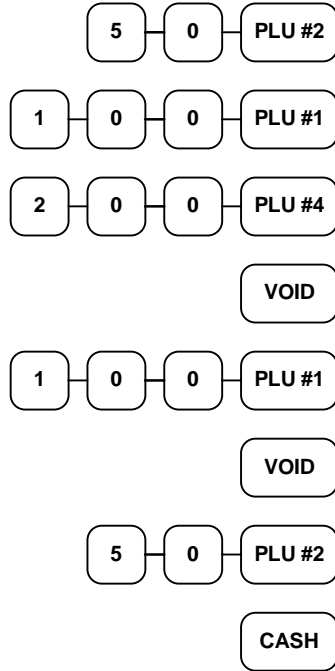

DATE	08/15/2003	SUN
PLU 2 T2		\$0.50
PLU 1 T1		\$1.00
PLU 4		\$2.00
VOID	-----	
PLU 1 T1		-1.00
VOID	-----	
PLU 2 T2		-0.50
TOTAL		\$2.00
C A S H		\$2.00
CLERK 01	No.00001	
TIME 12:00		00

Previous Item Void

Merchandise Return

Merchandise returns may be registered as part of a separate transaction, or as part of a transaction where other merchandise is sold. Press the **RETURN** key before entering the related PLU. Tax is credited if the item being returned is taxable.

5	0	0	RETURN	DATE 08/15/2003 SUN RETURN ***** PLU 1 T1 \$5.00 RETURN ***** 3X @2.00 PLU 4 -6.00 TAX1 AMT -0.25 TOTAL -11.25 C A S H -11.25 CLERK 01 No.00001 TIME 12:00 00	Merchandise Return Multiple Item Merchandise Return
PLU #1			RETURN		
3			X/TIME		
2	0	0	PLU #4		
<div style="border: 1px solid black; border-radius: 10px; padding: 2px; display: inline-block;">CASH</div>					

1	0	0	RETURN	DATE 08/15/2003 SUN RETURN ***** PLU 4 -1.00 DISCOUNT 1 -10.000% AMOUNT \$0.10 TOTAL -0.90 C A S H -0.90 CLERK 01 No.00001 TIME 12:00 00	Merchandise Return of Discounted Merchandise		
PLU #4			PLU #4				
%1			%1				
<div style="border: 1px solid black; border-radius: 10px; padding: 2px; display: inline-block;">CASH</div>							
<div style="border: 1px solid black; border-radius: 10px; padding: 2px; display: inline-block;">CASH</div>							
<div style="border: 1px solid black; border-radius: 10px; padding: 2px; display: inline-block;">CASH</div>							

VOID Control Lock Position (Transaction Void)

Most operations, which can be performed with the control lock in the REG position, can also be done with the control lock in the **VOID** position. The exceptions are Merchandise Returns, Error correct, and previous item voids within a sale. **VOID** position operations will adjust all sale totals, and the **VOID** (Transaction Void) position carries its own total on the Financial report.

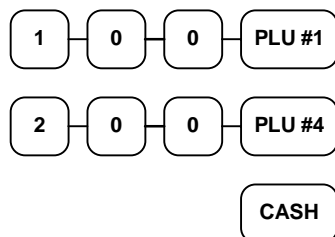

DATE	08/15/2003	SUN
PLU 1 T1		\$1.00
PLU 4		\$2.00
TAX1 AMT		\$0.05
TOTAL		\$3.05
C A S H		\$3.05
CLERK 01	No.00001	
TIME 12:00		00

Original Transaction

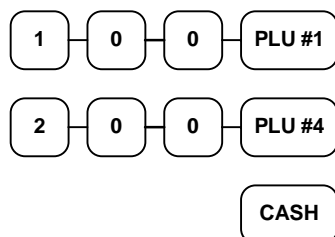

DATE	08/15/2003	SUN
VOID MODE	*****	
PLU 1 T1		-1.00
PLU 4		-2.00
TAX1 AMT		-0.05
TOTAL		-3.05
C A S H		-3.05
CLERK 01	No.00001	
TIME 12:00		00

Transaction Void of Original Transaction

Cancel

Press the **CANCEL** key anytime during a transaction to cancel that transaction. (This is not a tender key.) Transactions of up to a maximum of thirty items may be canceled. If a cancel function is attempted after the entering more than thirty items, the function is not allowed and the error tone will sound.

The only total affected is the Cancel total, to which the total of all positive entries is added.

<table border="0"><tr><td>2</td><td>0</td><td>0</td><td>PLU #1</td></tr><tr><td>3</td><td>0</td><td>0</td><td>PLU #1</td></tr><tr><td>1</td><td>0</td><td>0</td><td>PLU #4</td></tr></table>	2	0	0	PLU #1	3	0	0	PLU #1	1	0	0	PLU #4	<table border="1"><tr><td>DATE 08/15/2003</td><td>SUN</td></tr><tr><td>PLU 1 T1</td><td>\$2.00</td></tr><tr><td>PLU 1 T1</td><td>\$3.00</td></tr><tr><td>PLU 4</td><td>\$1.00</td></tr><tr><td>CANCEL</td><td>*****</td></tr><tr><td>CLERK 01</td><td>No.00001</td></tr><tr><td>TIME 12:00</td><td>00</td></tr></table>	DATE 08/15/2003	SUN	PLU 1 T1	\$2.00	PLU 1 T1	\$3.00	PLU 4	\$1.00	CANCEL	*****	CLERK 01	No.00001	TIME 12:00	00	<p><i>Canceled Transaction</i></p>
2	0	0	PLU #1																									
3	0	0	PLU #1																									
1	0	0	PLU #4																									
DATE 08/15/2003	SUN																											
PLU 1 T1	\$2.00																											
PLU 1 T1	\$3.00																											
PLU 4	\$1.00																											
CANCEL	*****																											
CLERK 01	No.00001																											
TIME 12:00	00																											
<table border="0"><tr><td>CANCEL</td></tr></table>	CANCEL																											
CANCEL																												

Subtotal Operations

Subtotal

Press the **SBTL** key at anytime during a transaction to view the total due, including tax and after adjustments. The display will indicate **Sub** for subtotal.

Tray Subtotal (Add Check)

In a cafeteria, use the **TRAY SUBTOTAL** key to add multiple trays that are paid by a single individual (i.e. Dad pays all the trays for the family.) In a restaurant, use the **TRAY SUBTOTAL** key to accept multiple checks presented for payment.

Press the **TRAY SUBTOTAL** key after each order, and **SBTL** for the total of all orders. Finalize with any tender key as you would a normal sale.

4 0 0 PLU #1
TRAY
SBTL

5 0 0 PLU #1
TRAY
SBTL

CASH

DATE 08/15/2003 SUN

PLU 1 T1 \$4.00
TAX1 AMT \$0.20
TOTAL \$4.20
TRAY SBTL \$4.20
CLERK 01 No.00001
TIME 12:00 00

First Tray Added

DATE 08/15/2003 SUN

PLU 1 T1 \$5.00
TAX1 AMT \$0.25
TOTAL \$5.25
TRAY SBTL \$5.25
CLERK 01 No.00001
TIME 12:00 00

Second Tray Added

DATE 08/15/2003 SUN

TOTAL \$9.45
C A S H \$9.45
CLERK 01 No.00001
TIME 12:00 00

*Payment for Both
Trays*

Eat-In/Take-Out/Drive Thru Operations

In a restaurant, **EAT-IN**, **TAKE-OUT** and **DRIVE THRU** keys can be set up to provide totals for each type of sale. The **EAT-IN**, **TAKE-OUT** and **DRIVE THRU** keys may also be set up to remove taxes. For example, if your state charges sales tax for food consumed on the premises, while not charging sales tax for food taken home, sales tax can be exempted with the **TAKE-OUT** key. See "Eat-In - Function Key Programs" on page 127, "Take Out - Function Key Programs" on page 138, or "Drive Thru - Function Key Programs" on page 126 to set up tax status for these keys.

After registering all items, press **EAT-IN**, **TAKE-OUT** or **DRIVE THRU** (as you would use the Subtotal key), then finalize the sale as you normally would.

<div style="display: flex; align-items: center; margin-bottom: 10px;"> <div style="border: 1px solid black; border-radius: 50%; width: 30px; height: 30px; display: flex; align-items: center; justify-content: center; margin-right: 5px;">1</div> <div style="border: 1px solid black; border-radius: 50%; width: 30px; height: 30px; display: flex; align-items: center; justify-content: center; margin-right: 5px;">0</div> <div style="border: 1px solid black; border-radius: 50%; width: 30px; height: 30px; display: flex; align-items: center; justify-content: center; margin-right: 5px;">0</div> <div style="border: 1px solid black; border-radius: 5px; padding: 2px 5px; margin-left: 5px;">PLU #1</div> </div> <div style="border: 1px solid black; border-radius: 5px; padding: 2px 5px; margin-bottom: 10px; width: fit-content; margin-left: 100px;">PLU #3</div> <div style="border: 1px solid black; border-radius: 5px; padding: 2px 5px; margin-bottom: 10px; width: fit-content; margin-left: 100px;">EAT IN</div> <div style="border: 1px solid black; border-radius: 5px; padding: 2px 5px; width: fit-content; margin-left: 100px;">CASH</div>	<pre> DATE 08/15/2003 SUN PLU 1 T1 \$1.00 PLU 3 T12 \$3.00 TAX1 AMT \$0.20 TAX2 AMT \$0.30 ==== EAT-IN ==== TOTAL \$4.50 C A S H \$4.50 CLERK 01 No.00001 TIME 12:00 00 </pre>	<p><i>EAT IN Transaction (Tax is Charged)</i></p>
<div style="display: flex; align-items: center; margin-bottom: 10px;"> <div style="border: 1px solid black; border-radius: 50%; width: 30px; height: 30px; display: flex; align-items: center; justify-content: center; margin-right: 5px;">1</div> <div style="border: 1px solid black; border-radius: 50%; width: 30px; height: 30px; display: flex; align-items: center; justify-content: center; margin-right: 5px;">0</div> <div style="border: 1px solid black; border-radius: 50%; width: 30px; height: 30px; display: flex; align-items: center; justify-content: center; margin-right: 5px;">0</div> <div style="border: 1px solid black; border-radius: 5px; padding: 2px 5px; margin-left: 5px;">PLU #1</div> </div> <div style="border: 1px solid black; border-radius: 5px; padding: 2px 5px; margin-bottom: 10px; width: fit-content; margin-left: 100px;">PLU #3</div> <div style="border: 1px solid black; border-radius: 5px; padding: 2px 5px; margin-bottom: 10px; width: fit-content; margin-left: 100px;">TAKE OUT</div> <div style="border: 1px solid black; border-radius: 5px; padding: 2px 5px; width: fit-content; margin-left: 100px;">CASH</div>	<pre> DATE 08/15/2003 SUN PLU 1 T1 \$1.00 PLU 3 T12 \$3.00 === TAKE-OUT === TOTAL \$4.00 C A S H \$4.00 CLERK 01 No.00001 TIME 12:00 00 </pre>	<p><i>TAKE OUT Transaction (Tax is Removed from Taxable Items)</i></p>
<div style="border: 1px solid black; border-radius: 5px; padding: 2px 5px; margin-bottom: 10px; width: fit-content; margin-left: 100px;">PLU #3</div> <div style="border: 1px solid black; border-radius: 5px; padding: 2px 5px; margin-bottom: 10px; width: fit-content; margin-left: 100px;">DRIVE THRU</div> <div style="border: 1px solid black; border-radius: 5px; padding: 2px 5px; width: fit-content; margin-left: 100px;">CASH</div>	<pre> DATE 08/15/2003 SUN PLU 3 T12 \$3.00 === DRIVE THRU === TOTAL \$3.00 C A S H \$3.00 CLERK 01 No.00001 TIME 12:00 00 </pre>	<p><i>DRIVE THRU Transaction (Tax is Removed from Taxable Items)</i></p>

Tax Shift Operations

When tax shift operations are performed, the shift light on the display will illuminate.

- To charge a tax or taxes on a non-taxable item press the appropriate tax shift key or keys prior to making the non-taxable PLU entry.
- To except a tax or taxes on a taxable item press the appropriate tax shift key or keys prior to making the taxable PLU entry.
- To except a tax or taxes from an entire sale, press the appropriate tax shift key or keys prior to finalizing the transaction.

<div style="display: flex; justify-content: space-around; align-items: center;"> <div style="border: 1px solid black; border-radius: 10px; width: 30px; height: 30px; text-align: center; line-height: 30px;">2</div> <div style="border: 1px solid black; border-radius: 10px; width: 30px; height: 30px; text-align: center; line-height: 30px;">0</div> <div style="border: 1px solid black; border-radius: 10px; width: 30px; height: 30px; text-align: center; line-height: 30px;">0</div> <div style="border: 1px solid black; border-radius: 10px; padding: 2px 5px;">PLU #4</div> </div> <div style="margin-top: 10px; text-align: center;"> <div style="border: 1px solid black; border-radius: 10px; padding: 2px 5px;">TAX 1 SHIFT</div> <div style="border: 1px solid black; border-radius: 10px; padding: 2px 5px;">CASH</div> </div>	<pre> DATE 08/15/2003 SUN PLU 4 T1 \$2.00 TAX1 AMT \$0.10 TOTAL \$2.10 C A S H \$2.10 CLERK 01 No.00001 TIME 12:00 00 </pre>	<p><i>To Charge Tax On A Non-Taxable PLU</i></p>
--	--	---

<div style="display: flex; justify-content: space-around; align-items: center;"> <div style="border: 1px solid black; border-radius: 10px; width: 30px; height: 30px; text-align: center; line-height: 30px;">2</div> <div style="border: 1px solid black; border-radius: 10px; width: 30px; height: 30px; text-align: center; line-height: 30px;">0</div> <div style="border: 1px solid black; border-radius: 10px; width: 30px; height: 30px; text-align: center; line-height: 30px;">0</div> <div style="border: 1px solid black; border-radius: 10px; padding: 2px 5px;">PLU #1</div> </div> <div style="margin-top: 10px; text-align: center;"> <div style="border: 1px solid black; border-radius: 10px; padding: 2px 5px;">TAX 1 SHIFT</div> <div style="border: 1px solid black; border-radius: 10px; padding: 2px 5px;">CASH</div> </div>	<pre> DATE 08/15/2003 SUN PLU 1 \$2.00 TOTAL \$2.00 C A S H \$2.00 CLERK 01 No.00001 TIME 12:00 00 </pre>	<p><i>To Except Tax On A Taxable PLU</i></p>
--	---	---

1 0 0 PLU #1

2 0 0 PLU #3

SBTL

TAX 1
SHIFT

TAX 2
SHIFT

SBTL

CASH

DATE	08/15/2003	SUN
PLU 1 T1		\$1.00
PLU 3 T12		\$2.00
TOTAL		\$3.00
C A S H		\$3.00
CLERK 01	No.00001	
TIME 12:00		00

To Except Specific Taxes On Entire Sale

1 0 0 PLU #1

2 0 0 PLU #3

SBTL

TAX
EXEMPT

SBTL

CASH

DATE	08/15/2003	SUN
PLU 1 T1		\$1.00
PLU 3 T12		\$2.00
TOTAL		\$3.00
C A S H		\$3.00
CLERK 01	No.00001	
TIME 12:00		00

To Except Tax On Entire Sale with Pre-Programmed Tax Exempt Key

Tendering Operations

Cash

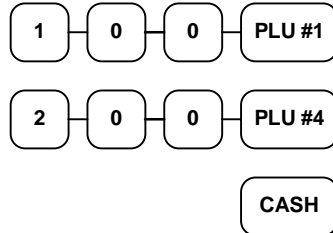

DATE	08/15/2003	SUN
PLU 1 T1		\$1.00
PLU 4		\$2.00
TAX1 AMT		\$0.05
TOTAL		\$3.05
C A S H		\$3.05
CLERK 01	No.00001	
TIME 12:00		00

Cash Tender
(exact amount of purchase)

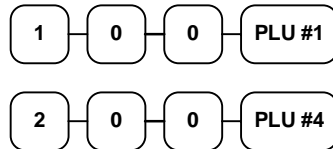

DATE	08/15/2003	SUN
PLU 1 T1		\$1.00
PLU 4		\$2.00
TAX1 AMT		\$0.05
TOTAL		\$3.05
C A S H		\$4.00
C H A N G E		\$0.95
CLERK 01	No.00001	
TIME 12:00		00

Cash Tender with Change

Check

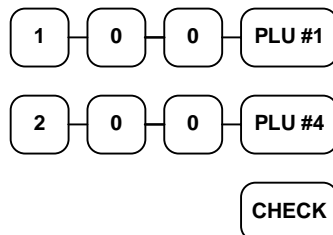

DATE	08/15/2003	SUN
PLU 1 T1		\$1.00
PLU 4		\$2.00
TAX1 AMT		\$0.05
TOTAL		\$3.05
C H E C K		\$3.05
CLERK 01	No.00001	
TIME 12:00		00

Check Tender
(exact amount of purchase)

1 0 0 PLU #1
 2 0 0 PLU #4

DATE 08/15/2003 SUN
 PLU 1 T1 \$1.00
 PLU 4 \$2.00
 TAX1 AMT \$0.05
 TOTAL \$3.05
C H E C K \$4.00
C H A N G E \$0.95
 CLERK 01 No.00001
 TIME 12:00 00

Check Tender with Change

1 0 0 0 CHECK CASH

DATE 08/15/2003 SUN
 **** CHECK-CASH ****
C H E C K \$10.00
C A S H -10.00
 CLERK 01 No.00001
 TIME 12:00 00

Check Cashing

Charge

Tendering and over tendering into charge keys is allowed.

1 0 0 PLU #1
 2 0 0 PLU #4
 CHARGE 1

DATE 08/15/2003 SUN
 PLU 1 T1 \$1.00
 PLU 4 \$2.00
 TAX1 AMT \$0.05
 TOTAL \$3.05
C H A R G E 1 \$3.05
 CLERK 01 No.00001
 TIME 12:00 00

Charge Total

Split Tender

The drawer will not open until the final balance has been paid.

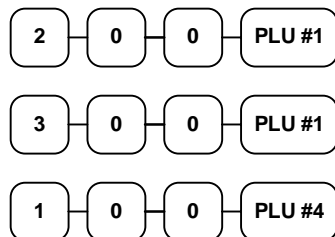

DATE	08/15/2003	SUN
PLU 1 T1		\$2.00
PLU 1 T1		\$3.00
PLU 4		\$1.00
TAX1 AMT		\$0.25
TOTAL		\$6.25
C A S H		\$2.00
TOTAL		\$4.25
C H E C K		\$2.00
TOTAL		\$2.25
C H A R G E 1		\$2.25
CLERK 01	No.00001	
TIME 12:00		00

**Cash, Check &
Charge Payments on
the Same
Transaction**

Post Tendering

Post tendering is available for computing change after a sale has been finalized. (See program option #33 in "System Option Programming" on page 108 to enable post tendering.) The second cash entry is compared to the sale total and the difference is displayed. (The **CLEAR** key must first be pressed for registers programmed with pop-up clerks.)

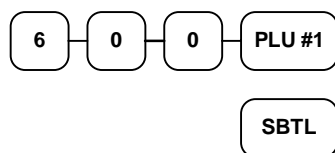

DATE	08/15/2003	SUN
PLU 1 T1		\$6.00
TAX1 AMT		\$0.30
TOTAL		\$6.30
C A S H		\$6.30
CLERK 01	No.00001	
TIME 12:00		00

Post Tender

Receipt on Request

If a customer requests a receipt after a sale has been finalized, a second depression of the **CASH** key will issue a complete buffered receipt.

If more than 200 entries are made in the sale, the register will issue a stub receipt only, showing the total net sale, correct tax totals and payment tendered.

Validation

Validations can be performed after PLU entries, received on account and paid out operations, % key entries, merchandise returns, voids, and tendering operations by pressing the **VALID** key.

If an operation is programmed with validation compulsory, the cash drawer will not open until the compulsion is satisfied. The **SP** message will appear on the display, and the indicator light behind **VALID** will come on once the form is properly inserted in the receipt/journal printer. The error tone will sound if any other operations are attempted before validation is completed.

Validated PLU Entry

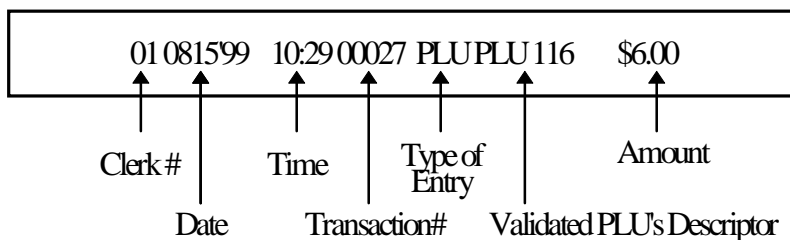

Validated Received On Account Operation

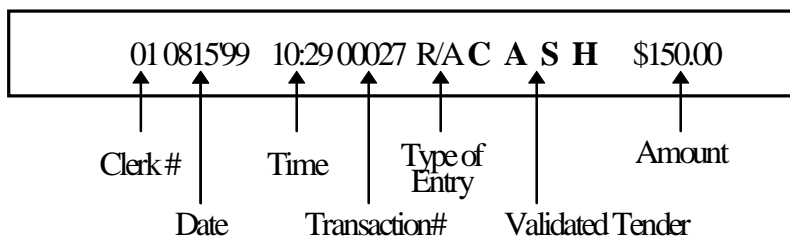

Validated Check Tender Transaction

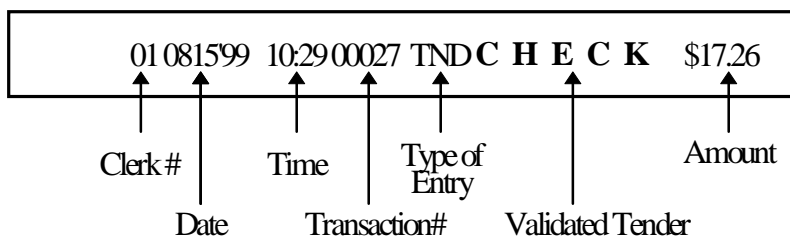

Training Mode

A training mode is available so that you can operate the cash register without updating totals and counters. Note the following conditions:

- The receipt and journal print the message "TRAINING MODE BEGIN" when training mode is activated.
- The receipt and journal print the message "TRAINING MODE END" when training mode is exited.
- The message "TRAINING MODE" prints on each receipt printed while training mode is active.
- The journal does not print during training mode.
- The total and counter on the financial report labeled "TRAIN TTL" is updated with the net amount of each training transaction.

To Enter Training Mode

- ◆ Set system option #32 to a value of **1**. See "System Option Programming" on page 108.

To Exit Training Mode

- ◆ Set system option #32 to a value of **0**. See "System Option Programming" on page 108.

Non-Add Number

With the **#/NS** key, you can enter a memo number at any time and print the number on the receipt, journal, or validation. The non-adding number is not added to the sale, nor is it added to any register total, except the # key total itself. You can enter a number up to 8 digits. For example:

- Enter a number prior to a PLU entry to print a record of the item's SKU number.
- Enter a number prior to a Check tender to print a record of the check number.
- Enter a number prior to a Charge to print a record of the charge account number.

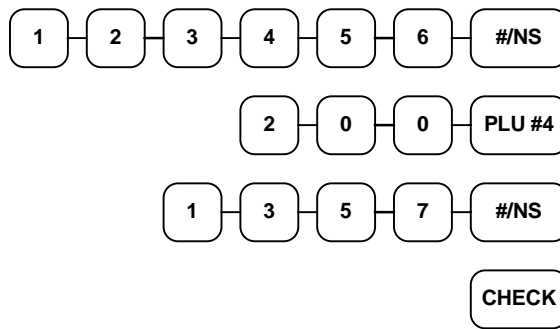

DATE	08/15/2003	SUN
NON-ADD#		123456
PLU 1 TL		\$2.00
TAX1 AMT		\$0.10
TOTAL		\$2.10
NON-ADD#		1357
C H E C K		\$2.10
CLERK 01	No.	00001
TIME 12:00		00

No Sale

Outside of a transaction, press the **#/NS** key to open the cash drawer. The number of no sales are counted and reported on the financial report. The no sale function can also be placed under management control, requiring the control key to be in the **X** position. See "**#/No Sale - Function Key Programs**" on page 119 to set this option.

#/NS

DATE	08/15/2003	SUN
NOSALE	-----	
CLERK 01	No.	00001
TIME 12:00		00

Received on Account

Use the **RECD ACCT** key to record payments or loans to the cash drawer. You can enter more than one type of payment to the drawer. The Received on Account function can only be used outside of a transaction.

				RECD ACCT	
1	2	5	0	CASH	
2	0	0	0	CHECK	
				RECD ACCT	

DATE 08/15/2003 SUN

R/A

C A S H \$12.50

C H E C K \$20.00

R/A \$32.50

CLERK 01 No.00001

TIME 12:00 00

You can also compute change when receiving payments. For example:

				RECD ACCT	
1	0	0			
5	0	0		CASH	

DATE 08/15/2003 SUN

R/A \$1.00

C A S H \$5.00

C H A N G E \$4.00

CLERK 01 No.00001

TIME 12:00 00

Paid Out

Use the **PAID OUT** key to record payments or loans from the cash drawer. You can enter more than one type of payment to the drawer. The Paid Out function can only be used outside of a transaction.

				PAID OUT		
					DATE	08/15/2003 SUN
					P/O	
					C A S H	\$12.50
					C H E C K	\$20.00
					P/O	\$32.50
					CLERK 01	No.00001
					TIME 12:00	00

1	2	5	0	CASH	
2	0	0	0	CHECK	

				PAID OUT	
--	--	--	--	---------------------	--

Restaurant Operations

The *SAM4s ER-5115* can be used to add items or receive payments on guest checks. To use these features, the appropriate function keys must be included on the keyboard. See "Function Key Assignment Programming" on page 91 to assign the **P/BAL**, **TABLE #**, **GUEST #**, and/or **SERVICE** functions. Assign a % key and program it appropriately to set up a **CHARGE TIP** function key.

Note: If you wish to print guest check transactions on a slip or guest check, an optional printer must be installed. See your *SAM4s* dealer for more information.

Posting Guest Checks with the Previous Balance Key

The previous balance key is used to enter the amount of the previous balance before adding new items or making payments.

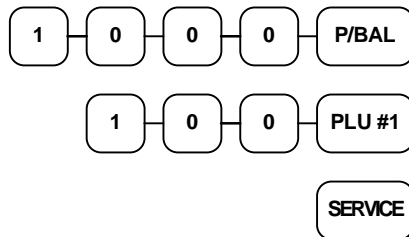

DATE 08/15/2003	SUN
P/BAL	\$10.00
PLU 1 T1	\$1.00
TAX1 AMT	\$0.05
SERVICE	\$1.05
BFWD	\$11.05
CLERK 01	No.00001
TIME 12:00	00

Adding to an Existing Balance

Tracking Balances with the TABLE # Key

The SAM4s ER-5115 can retain up to 100 current balances in memory. The balance is accessed by entering the tracking number (in a restaurant, this is usually the table number) and pressing the **TABLE #** key. Tracking numbers from 1 to 100 may be used. The **GUEST #** key can be used to enter the guest count. See "Guest # - Function Key Programs" on page 130 to enforce the guest count entry before a guest check is started.

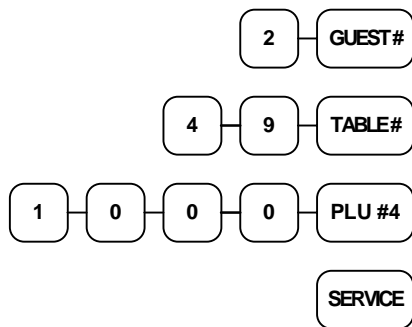

DATE	08/15/2003	SUN
GUEST #		#2
TABLE #		#49
P/BAL		\$0.00
PLU 4		\$10.00
SERVICE		\$10.00
BFWD		\$10.00
CLERK 01	No.	00001
TIME 12:00		00

Entering Guest Count and Opening a new Check

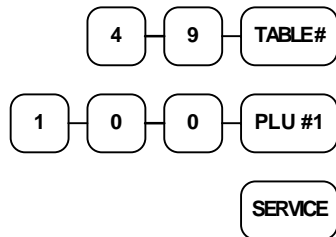

DATE	08/15/2003	SUN
TABLE #		#49
P/BAL		\$10.00
PLU 1 T1		\$1.00
TAX1 AMT		\$0.05
SERVICE		\$1.05
BFWD		\$11.05
CLERK 01	No.	00002
TIME 12:00		00

Adding to an Existing Table Balance

Payments

Payments may be received any time after a balance is entered or recalled. New items can be added during the same transaction.

4 9 TABLE#

1 0 0 PLU #1

SBTL

2 0 0 0 CASH

DATE	08/15/2003	SUN
TABLE #	#49	
P/BAL	\$11.05	
PLU 1 T1	\$1.00	
TAX1 AMT	\$0.05	
CHKPAID	\$12.10	
TOTAL	\$12.10	
CASH	\$20.00	
CHANGE	\$7.90	
CLERK 01	No.00003	
TIME 12:00	00	

Adding to an Existing Table Balance and Receiving a Cash Payment

4 9 TABLE#

SBTL

1 0 0 CHARGE TIP

CHARGE 1

DATE	08/15/2003	SUN
TABLE #	#49	
P/BAL	\$11.05	
CHARGE TIP	\$1.00	
CHKPAID	\$12.05	
TOTAL	\$12.05	
CHARGE 1	\$12.05	
CLERK 01	No.00001	
TIME 12:00	00	

Adding a Charge Tip and Paying by Charge

Optional Check Printer Sample Printout

If an optional slip printer is attached, the print format for guest check printing is shown below.

GUEST #	#2		
TABLE #	#49		
P/BAL	\$0.00		
PLU 4	\$10.00		
SERVICE	\$10.00		
BFWD	\$10.00		
CLERK 01	08/15/2003	12:00	
00			00001
TABLE #	#49		
P/BAL	\$10.00		
PLU 1 T1	\$1.00		
TAX1 AMT	\$0.05		
SERVICE	\$1.05		
BFWD	\$11.05		
CLERK 01	08/15/2003	12:00	
00			00002
TABLE #	#49		
P/BAL	\$11.05		
PLU 1 T1	\$1.00		
TAX1 AMT	\$0.05		
CHKPAID	\$12.10		
TOTAL	\$12.10		
CASH	\$20.00		
CHANGE	\$7.90		
CLERK 01	08/15/2003	12:00	
00			00003

Promo Function

The **PROMO** key allows the operator to account for promotional items (i.e. buy two, get one free). By design, this key will remove the items cost from the sale, but not the count. In the example of buy two, get one free, the reported count remains three items, but the customer is only charged for two.

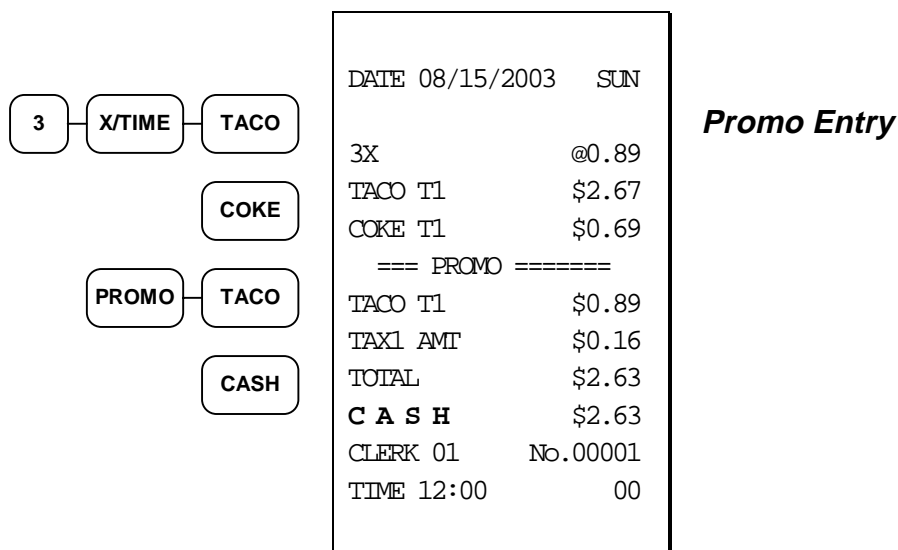

Waste Function

The **WASTE** key allows control of inventory by accounting for items that must be removed from stock due to spoilage, breakage, or mistakes. With manager control, the **WASTE** key requires the control lock to be in the **X** position. The **WASTE** key is not allowed within a sale.

Waste operations begin and end with by pressing the **WASTE** key.

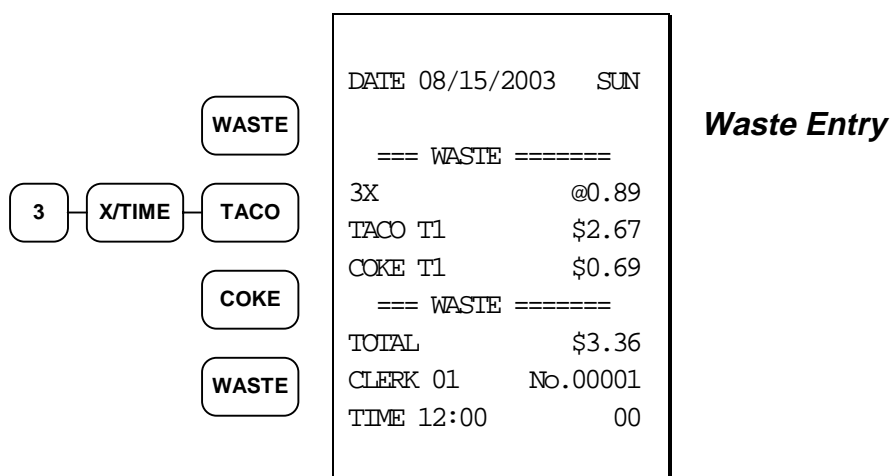

Currency Conversion

If you normally accept currency from a neighboring nation, you can program the *SAM4s ER-5115* to convert the subtotal of a sale to the equivalent cost in the foreign currency. Two foreign currency conversion keys are available. See "Function Key Assignment Programming" on page 91 to place currency conversion keys on the keyboard. You also need to program the conversion factor. For example, if the US dollar (home currency) is worth 1.3720 Canadian dollars (foreign currency), the conversion factor is 1.3720. See "Currency Conversion - Function Key Programs" on page 125 to set a conversion rate.

Note: The change due is computed in home currency!

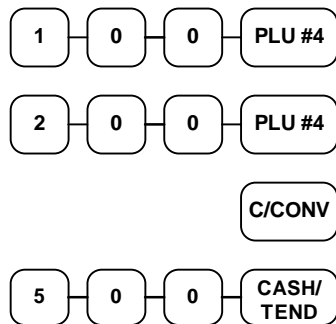

DATE 08/15/2003	SUN
PLU 1	\$1.00
PLU 4	\$2.00
TOTAL	\$3.00
CONV1	@5.00
CHANGE RATE	#1.3720
HOME AMT	\$3.64
CHANGE	\$0.64
CLERK 01	No.00001
TIME 12:00	00

**Currency
Conversion
Transaction**

Food Stamp Operations

The *SAM4s ER-5115* can be set up to sort food stamp eligible merchandise and accept food stamp payments. See "Function Key Assignment Programming" on page 91 to place the necessary function keys (**F/S SHIFT**, **F/S SUB**, **F/S TEND**) on the keyboard. You will also need to set food stamp eligibility status for each open or preset PLU (see "Program 100 - PLU Status Programming" on page 99.)

- If necessary, you can use the **F/S SHIFT** key to shift the pre-programmed eligibility status for any item as it is entered. For example, while produce is normally food stamp eligible, certain produce department items, such as birdseed, cannot be paid for with food stamps. In this case, program the produce PLU as food stamp eligible, then press **F/S SHIFT** before registering a non-eligible produce item.
- If a customer chooses to pay with food stamps, press the **F/S SUB** key to display a total of food stamp eligible merchandise.
- Tender food stamp payments into the **F/S TEND** key. Change less than \$1 is given in cash, or applied to non-food stamp eligible items. After finalization, food stamp change in whole dollars is displayed on the left portion of the display, while cash change is displayed on the right portion of the display.

			F/STAMP SHIFT	
1	2	9	PLU #4	
1	0	0	PLU #4	
			F/STAMP SBTL	
5	0	0	F/STAMP TENDER	
1	0	0	CASH/ TEND	

DATE 08/15/2003	SUN
PLU 1 F	\$1.29
PLU 4	\$1.00
TOTAL	\$2.29
F/S TOTAL	\$1.29
F/D TEND	5.00
F/S CRT AMT	\$0.71
TOTAL	\$0.29
CASH	\$1.00
CHANGE	\$0.71
FD/S CHANGE	\$3.00
CLERK 01	No.00001
TIME 12:00	00

Food Stamp Payment Transaction

Scale Operations

The SAM4s ER-5115 can be interfaced to an optional load-cell scale, allowing direct entry of an item's weight by using the **SCALE** key. If you attempt an entry into a PLU that has been programmed to require scale entry, (see "Program 100 - PLU Status Programming" on page 99) an error tone will sound and you will be prompted to make a scale entry.

Direct Scale Entry

Place a product on the scale and press the **SCALE** key to display the weight on the cash register. Then make the appropriate PLU entry.

SCALE → 1 → 0 → 0 → PLU #3
SCALE → 5 → 4 → 0 → PLU
CASH

DATE	08/15/2003	SUN
1.50 lb	@ 3.00	
PLU 3 T12		\$4.50
1.75 lb	@ 1.00	
PLU 4		\$1.75
1.25 lb	@ 2.50	
PLU 540		\$3.13
TAX1 AMT		\$0.23
TAX2 AMT		\$0.45
TOTAL		\$10.06
CASH		\$10.06
CLERK 01	No.	000001
TIME 12:00		00

Preset Keyboard PLU

Open Keyboard PLU

Preset PLU

Manual Weight Entry

Operators can make manual weight entries if the item has been programmed to accept them (see "Program 100 - PLU Status Programming" on page 99). You must use the decimal key to enter fractional manual weights.

1 → . → 5 → 0 → 0 → SCALE
1 → 0 → 0 → PLU #4
CASH

DATE	08/15/2003	SUN
1.50 lb	@ 1.00	
PLU 4		\$1.50
TOTAL		\$1.50
CASH		\$1.50
CLERK 01	No.	000001
TIME 12:00		00

Manual Scale Entry

Scale With Automatic Tare Entry

Place a product on the scale, enter the preprogrammed tare number and press the **SCALE** key. The weight, less the tare, will appear on the cash register display. Then make the appropriate PLU entry.

1	→	SCALE	DATE 08/15/2003 SUN 1.50 lb @ 1.00 PLU 4 \$1.50 TOTAL \$1.50 CASH \$1.50 CLERK 01 No.00001 TIME 12:00 00	Automatic Tare Entry				
1	→	0			→	0	→	PLU #4
					CASH			

Scale With Manual Tare Entry

Tare #5 can be used to manually enter tare weights. Place a product on the scale, enter **5** and press the **SCALE** key. Enter the tare weight (using the decimal key), and press the **SCALE** key. The tare weight will display. Press the **SCALE** key again, and the weight, less the tare will display. Then make the appropriate PLU entry.

5	→	SCALE	DATE 08/15/2003 SUN 1.50 lb @ 1.00 PLU 4 \$1.50 TOTAL \$1.50 CASH \$1.50 CLERK 01 No.00001 TIME 12:00 00	Manual Tare Entry				
.	→	5			→	2	→	SCALE
					SCALE			
1	→	0			→	0	→	PLU #4
					CASH			

Notes

Management Functions

Introduction

All Management Functions take place with the control lock in the **X** position. In this way only those with the correct key will have access to these functions. Some register operations may be programmed to require the control lock in the **X** position in order to operate. All reports require a key that will access the **X** or **Z** position.

In this chapter you will find:

- "Manager Authorization Of Restricted Operations" on page 63
- "Changing the Default PLU Level" on page 64
- "Cash Declaration" on page 64
- "System Reports" on page 66

Manager Authorization Of Restricted Operations

If pressing a function key causes an error condition when used properly, the function may require the control lock in the **X** (or Management) position. See "Function Key Programming" on page 109 for setting these conditions.

Function keys, which may be programmed to require the control lock in the **X** position, are:

- Void
- Received on Account
- Paid Out
- Merchandise Return
- % Keys
- Check Cashing

Changing the Default PLU Level

The default level is the *top*, or *surface* level returned to after each PLU entry when options are set for pop-up levels. For example, if levels are set to pop-up and default level is set to 2, after registering an item in level 1 or level 3, subsequent registrations will automatically return to level 2.

To set default PLU level:

1. Turn the control lock to the **X**, or **P** key position
2. Press the desired level key twice to set that level as default.



Cash Declaration

If compulsory cash declaration is required, (see option #1, "System Option Programming" on page 108) you must declare the count of the cash drawer prior to taking **X** or **Z** financial and clerk reports.

You can enter the cash drawer total in one step, or to facilitate the counting of the cash drawer, you can enter each type of bill/coin and checks separately and let the register act as an adding machine. You can also use the **X/TIME** key to multiply the denomination of currency times your count.

Either way you choose to enter cash, the register will compare your declaration with the expected cash and check in drawer totals and print the over or short amounts on the report.

For example:

1. Turn the control lock to the **X** or **Z** position (depending upon the type of report you are taking.)
2. Press the **CASH** key.



3. Enter the total of cash.

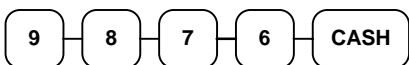

4. Enter the total of checks.

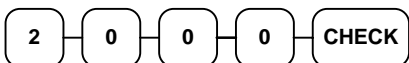

5. Press the **CASH** key to total the declaration.



DATE 08/15/2003	SUN
* CASH DECLARATION! *	
CASH	\$98.76
CHECK	\$20.00
Total	\$118.76
CLERK 01	No.00001
TIME 12:00	00

Or, enter each denomination separately:

1. Turn the control lock to the **X** or **Z** position
(depending upon the type of report you are taking.)
2. Press the **CASH** key.

CASH

3. Enter the total of pennies:

7 **6** **CASH**

4. If you wish you can multiply the count times the denomination. Enter, for example:

3 **0** **X/TIME**

5 **CASH**

5. Enter the remaining cash separately by denomination.
6. Enter each check:

1 **2** **0** **0** **CHECK**

8 **0** **0** **CHECK**

7. Press the **CASH** key to total the declaration.

CASH

DATE 08/15/2003	SUN
* CASH DECLARATION! *	
C A S H	\$0.76
C A S H	\$1.50
C A S H	\$3.10
C A S H	\$4.75
C A S H	\$28.00
C A S H	\$35.00
C A S H	\$50.00
C H E C K	\$12.00
C H E C K	\$8.00
Total	\$118.76
CLERK 01	No.00001
TIME 12:00	00

System Reports

System reports are divided into two basic categories:

- **X** reports, which read totals without resetting
- **Z** reports, which read totals and reset them to zero

Most reports are available in both categories. Some reports, such as the Cash-in-Drawer report and the From-To PLU report are available only as **X** reports.

Some reports also provide identical but separate *period to date* reports. These reports maintain a separate set of totals which may be allowed to accumulate over a period of days, weeks, months, or even years. **X2** reports read period to date totals without resetting, and **Z2** reports read period to date totals and reset them to zero. Period to date totals are updated each time a **Z1** report is completed.

A complete list of available reports is presented in a chart on the following page.

An example is given for each of these reports in the pages that follow. Those reports, which may be optionally abbreviated through register programming, are represented twice. They are first shown with the option off, giving all totals, and again with the option turned on, showing the abbreviated version of the same report.

Registers programmed with pop-up clerks must be signed on in the **REG** control lock position prior to taking reports.

Running a Report - General Instructions

1. Refer to the "Report Table" on page 67.
2. Select a report type and the report mode.
3. Turn the control lock to the position indicated.
4. Enter the key sequence for the report you have selected.

Report Table

Report Type	Report Number	Report Mode	Control Lock Position	Key Sequence
Financial	1	X	X	1 - SBTL
		Z	Z	1 - SBTL
		X2	X	201 - SBTL
		Z2	Z	201 - SBTL
Time	2	X	X	2 - SBTL
		Z	Z	2 - SBTL
		X2	X	202 - SBTL
		Z2	Z	202 - SBTL
All PLU	3	X	X	3 - SBTL
		Z	Z	3 - SBTL
		X2	X	203 - SBTL
		Z2	Z	203 - SBTL
All Clerk	4	X	X	4 - SBTL
		Z	Z	4 - SBTL
		X2	X	204 - SBTL
		Z2	Z	204 - SBTL
Cash-in-Drawer	5	X	X	5 - SBTL
Check-in-drawer	6	X	X	6 - SBTL
Food Stamp-in-Drawer	7	X	X	7 - SBTL
Daily Sales	8	X2	X	208 - SBTL
		Z2	Z	208 - SBTL
Individual Clerk Report	9	X	X	9-SBTL-#-CLERK-#-CLERK
		Z	Z	9-SBTL-#-CLERK-#-CLERK
		X2	X	209-SBTL-#-CLERK-#-CLERK
		Z2	Z	209-SBTL-#-CLERK-#-CLERK
Item by Group	10	X	X	10 - SBTL
Open Table	11	X	X	11 - SBTL
		Z	Z	11 - SBTL
Inventory PLU	12	X	X	12 - SBTL
Group	20	X	X	20 - SBTL
		Z	Z	20 - SBTL
		X2	X	220 - SBTL
		Z2	Z	220 - SBTL
From/To PLU		X	X	XXXX - PLU - XXXX - PLU

Financial Report Example (Report #1)

DATE 08/15/2003	SUN	Date/Day
Z 1 REPORT	0002	Report Mode/Z Counter

FINANCIAL		Report Name
+PLU TTL	9.00	Positive PLU count
	\$139.00	Positive PLU total
-PLU TTL	0.00	Negative PLU count
	\$0.00	Negative PLU total
ADJUST TTL	9.00	Adjusted PLU count
	\$139.00	Adjusted PLU total

NONTAX	\$119.00	Non-tax sales total
TAX1 SALES	\$10.00	Taxable 1 sales total
TAX2 SALES	\$25.00	Taxable 2 sales total
TAX3 SALES	\$0.00	Taxable 3 sales total
TAX4 SALES	\$0.00	Taxable 4 sales total
TAX1	\$0.64	Tax 1 total
TAX2	\$1.75	Tax 2 total
TAX3	\$0.00	Tax 3 total
TAX4	\$0.00	Tax 4 total
XMIP1 SALES	\$6.00	Exempted Tax 1 total
XMIP1 SALES	\$0.00	Exempted Tax 2 total
XMIP1 SALES	\$0.00	Exempted Tax 3 total
XMIP1 SALES	\$0.00	Exempted Tax 4 total
EATIN TTL	1	Eat-In sales count
	\$10.00	Eat-In sales total
TAKEOUT TTL	1	Take Out sales count
	\$5.00	Take Out sales total
DRITHRU TTL	0	Drive Thru sales count
	\$0.00	Drive Thru sales total
%1	1	%1 Key count
	\$-1.00	%1 Key total
%2	1	%2 Key count
	\$-2.00	%2 Key total
%3	0	%3 Key count
	\$0.00	%3 Key total
%4	0	%4 Key count
	\$0.00	%4 Key total

continued next page

Financial Report Example, Continued

%5	0	%5 Key count
	\$0.00	%5 Key total
NET SALE	10	Customer count
	\$139.39	Net Sales total
CREDIT TAX1	1	Tax 1 credited count
	-0.33	Tax 1 credited total
CREDIT TAX2	0	Tax 2 credited count
	\$0.00	Tax 2 credited total
CREDIT TAX3	0	Tax 3 credited count
	\$0.00	Tax 3 credited total
CREDIT TAX4	0	Tax 4 credited count
	\$0.00	Tax 4 credited total
FD/S CREDIT	\$0.00	Food stamp amount credited
RETURN	1	Merchandise Return count
	-5.00	Merchandise Return total
ERROR CORR	1	Error correct count
	-10.00	Error correct total
PREVIOUS VD	1	Previous item void count
	-20.00	Previous item void total
MODE VOID	1	Void lock count
	-5.33	Void lock total
CANCEL	2	Cancel count
	\$20.00	Cancel total
GROSS SALES	\$153.05	Gross sales count
CASH SALES	7	Cash sales count
	\$74.39	Cash sales total
CHECK SALES	1	Check sales count
	\$10.00	Check sales total
R/A	1	Received on account count
	\$10.00	Received on account total
P/O	1	Paid out count
	-10.00	Paid out total
HASH TTL	0	HASH activity count
	\$0.00	HASH total
AUDACTION	1	Total of negative
	-5.33	sales count/total
NOSALE	1	No sale count
NON-ADD #	0	Non-add # total
CASH-IN-D	\$74.39	Cash in drawer total
CHECK-IN-D	1	Check count
	\$10.00	Check in drawer total

continued next page

Financial Report Example, Continued

FD/S-IN-D	0	Food stamp count
	\$0.00	Food stamp total
CHG1 SALES	1	Charge 1 count
	\$25.00	Charge 1 total
CHG2 SALES	1	Charge 2 count
	\$30.00	Charge 2 total
CHG3 SALES	0	Charge 3 count
	\$0.00	Charge 3 total
CHG4 SALES	0	Charge 4 count
	\$0.00	Charge 4 total
CHG5 SALES	0	Charge 5 count
	\$0.00	Charge 5 total
FOREIGN 1	\$0.00	Foreign currency totals
FOREIGN 2	\$0.00	1/2
DRWR TTL	\$139.39	Drawer total
PROMO	0	Promo item count
	\$0.00	Promo item total
WASTE	0	Waste item total
	\$0.00	Waste item total
TRAIN TTL	0	Training mode count
	\$0.00	Training mode total
BAL FORWARD	0	Balance forward count
	\$0.00	Balance forward total
GUESTS	0	Guest # count
P/BAL	0	Previous balance count
	\$0.00	Previous balance total
CHECKS PAID	0	Checks Paid count
	\$0.00	Checks Paid total
SERVICE	0	Service count
	\$0.00	Service total

GRAND		Non-resettable grand
	\$335.42	total
CLERK 01	No.00001	Clerk/Consecutive #
TIME 12:00	00	Time/Register #

Optional Abbreviated Financial Report Example

DATE 08/15/2003	SUN	Date/Day
Z 1 REPORT	0002	Report Mode/Z Counter

FINANCIAL		Report Name
ADJUST TTL	9.00	Adjusted PLU count
	\$139.00	Adjusted PLU total

NONTAX	\$119.00	Non-tax sales total
TAX1 SALES	\$10.00	Taxable 1 sales total
TAX2 SALES	\$25.00	Taxable 2 sales total
TAX3 SALES	\$0.00	Taxable 3 sales total
TAX1	\$0.64	Tax 1 total
TAX2	\$1.75	Tax 2 total
TAX3	\$0.00	Tax 3 total
EATIN TTL	1	Eat-In sales count
	\$10.00	Eat-In sales total
TAKEOUT TTL	1	Take Out sales count
	\$5.00	Take Out sales total
%1	1	%1 Key count
	\$-1.00	%1 Key total
%2	1	%2 Key count
	\$-2.00	%2 Key total
NET SALE	10	Customer count
	\$139.39	Net Sales total
FD/S CREDIT	\$0.00	Food stamp amount credited
ERROR CORR	1	Error correct count
	-10.00	Error correct total
PREVIOUS VD	1	Previous item void count
	-20.00	Previous item void total
MODE VOID	1	Void lock count
	-5.33	Void lock total
CANCEL	2	Cancel count
	\$20.00	Cancel total
GROSS SALES	\$153.05	Gross sales count
CASH SALES	7	Cash sales count
	\$74.39	Cash sales total
CHECK SALES	1	Check sales count
	\$10.00	Check sales total

continued next page

Optional Abbreviated Financial Report Example, Continued

R/A	1	Received on account count
	\$10.00	Received on account total
P/O	1	Paid out count
	-10.00	Paid out total
NOSALE	1	No sale count
NON-ADD #	0	Non-add # total
CASH-IN-D	\$74.39	Cash in drawer total
CHECK-IN-D	1	Check count
	\$10.00	Check in drawer total
FD/S-IN-D	0	Food stamp count
	\$0.00	Food stamp total
CHG1 SALES	1	Charge 1 count
	\$25.00	Charge 1 total
CHG2 SALES	1	Charge 2 count
	\$30.00	Charge 2 total
DRWR TIL	\$139.39	Drawer total

G R A N D		
	\$335.42	Non-resettable grand total
CLERK 01	No.00001	Clerk/Consecutive #
TIME 12:00	00	Time/Register #

Time Report Example (Report #2)

DATE 08/15/2003	SUN	Date/Day
Z 1 REPORT	0002	Report Mode/Z Counter

TIME		Report Name
8:00-9:00		Time period
CNT	3	count of sales
SALES AMT	\$3.16	sales amount
SALE RATE	1.65%	sales percentage
9:00-10:00		Time period
CNT	23	count of sales
SALES AMT	\$62.15	sales amount
SALE RATE	32.50%	sales percentage
10:00-11:00		Time period
CNT	25	count of sales
SALES AMT	\$125.89	sales amount
SALE RATE	65.84%	sales percentage
TOTAL CNT	51	Total # of sales
TOTAL AMT	\$191.20	Total sales
CLERK 01	No.00001	Clerk/Consecutive #
TIME 12:00	00	Time/Register #

All PLU Report Example (Report #3)

The PLU report example here is shown with optional sales rates calculated (percentage of sales for each PLU). See option #6, "System Option Programming" on page 108 to add or delete this information.

DATE 08/15/2003	SUN	Date/Day
Z 1 REPORT	0002	Report Mode/Z Counter

ALL PLU		Report Name
PLU 1		PLU descriptor
CNT	33.00	count of sales
SALES AMT	\$67.77	sales amount
SALE RATE	39.46%	sales percentage
PLU 2		PLU descriptor
CNT	3.00	count of sales
SALES AMT	\$12.00	sales amount
SALE RATE	6.98%	sales percentage
PLU 3		PLU descriptor
CNT	6.00	count of sales
SALES AMT	\$17.50	sales amount
SALE RATE	10.18%	sales percentage
PLU 4		PLU descriptor
CNT	7.00	count of sales
SALES AMT	\$31.05	sales amount
SALE RATE	18.07%	sales percentage
PLU 116		PLU descriptor
CNT	1	count of sales
SALES AMT	\$6.00	sales amount
SALE RATE	3.49%	sales percentage
PLU 118		PLU descriptor
CNT	1	count of sales
SALES AMT	\$1.25	sales amount
SALE RATE	0.72%	sales percentage
PLU 510		PLU descriptor
CNT	6.00	count of sales
SALES AMT	\$28.67	sales amount
SALE RATE	16.69%	sales percentage

continued next page

PLU Report Example, Continued

PLU 540		PLU descriptor
CNT	3	count of sales
SALES AMT	\$7.50	sales amount
SALE RATE	4.36%	sales percentage
TOTAL CNT	60.00	Total PLU count
TOTAL AMT	\$171.74	Total PLU sales
CLERK 01	No.00001	Clerk/Consecutive #
TIME 12:00	00	Time/Register #

All Clerk Report Example (Report #4)

The clerk report may be generated for all clerks or for individual clerks. The clerk report can include media information for cashier accountability (see example on next page). By default, the clerk report includes the basic sales information in the example below. The clerk report can also be programmed to include totals with zero balance. See option #7 "System Option Programming" on page 108 to change clerk reporting options.

DATE 08/15/2003	SUN	Date/Day
Z 1 REPORT	0002	Report Mode/Z Counter

ALL CLERK		Report Name
CLERK 01	10	Clerk #/Customer count
NET SALE	\$139.39	Clerk's net sales
DRWR TTL	\$139.39	Clerk's drawer total
CLERK 02		
CLERK 03		(Sales information is
CLERK 04		repeated for each of
CLERK 05		the fifteen clerks with
CLERK 06		sales activity)
CLERK 07		
CLERK 08		
CLERK 09		
CLERK 10		
CLERK 11		
CLERK 12		
CLERK 13		
CLERK 14		
CLERK 15		
CLERK 01	No.00001	Clerk/Consecutive #
TIME 12:00	00	Time/Register #

Clerk Report Example (With Cashier Totals)

DATE 08/15/2003	SUN	Date/Day
X 1 REPORT	0002	Report Mode/Z Counter

ALL CLERK		Report Name
CLERK 01	10	Clerk #/Customer count
NET SALE	\$139.39	Clerk's net sales
NONTAX	\$119.00	Non-tax sales total
TAX1 SALES	\$10.00	Taxable 1 sales total
TAX2 SALES	\$25.00	Taxable 2 sales total
TAX3 SALES	\$0.00	Taxable 3 sales total
TAX4 SALES	\$0.00	Taxable 4 sales total
TAX1	\$0.64	Tax 1 total
TAX2	\$1.75	Tax 2 total
TAX3	\$0.00	Tax 3 total
TAX4	\$0.00	Tax 4 total
%1	1	%1 Key count
	\$-1.00	%1 Key total
%2	1	%2 Key count
	\$-2.00	%2 Key total
%3	0	%3 Key count
	\$0.00	%3 Key total
%4	0	%4 Key count
	\$0.00	%4 Key total
%5	0	%5 Key count
	\$0.00	%5 Key total
CREDIT TAX1	1	Tax 1 credited count
	-0.33	Tax 1 credited total
CREDIT TAX2	0	Tax 2 credited count
	\$0.00	Tax 2 credited total
CREDIT TAX3	0	Tax 3 credited count
	\$0.00	Tax 3 credited total
CREDIT TAX4	0	Tax 4 credited count
	\$0.00	Tax 4 credited total
FD/S CREDIT	\$0.00	Food stamp amount credited
RETURN	1	Merchandise Return count
	-5.00	Merchandise Return total
ERROR CORR	1	Error correct count
	-10.00	Error correct total

continued next page

Clerk Report Example, Continued

PREVIOUS VD	1	Previous item void count
	-20.00	Previous item void total
VOID MODE	1	Void lock count
	-5.33	Void lock total
CANCEL	2	Cancel count
	\$20.00	Cancel total
R/A	1	Received on account count
	\$10.00	Received on account total
P/O	1	Paid out count
	-10.00	Paid out total
CASH-IN-D	\$74.39	Cash in drawer total
CHECK-IN-D	1	Check count
	\$10.00	Check in drawer total
FD/S-IN-D	0	Food stamp count
	\$0.00	Food stamp total
CHG1 SALES	1	Charge 1 count
	\$25.00	Charge 1 total
CHG2 SALES	1	Charge 2 count
	\$30.00	Charge 2 total
CHG3 SALES	0	Charge 3 count
	\$0.00	Charge 3 total
CHG4 SALES	0	Charge 4 count
	\$0.00	Charge 4 total
CHG5 SALES	0	Charge 5 count
	\$0.00	Charge 5 total
DRWR TTL	\$139.39	Drawer total
PROMO	0	Promo item count
	\$0.00	Promo item total
WASTE	0	Waste item total
	\$0.00	Waste item total
TRAIN TTL	0	Training mode count
	\$0.00	Training mode total
BAL FORWARD	0	Balance forward count
	\$0.00	Balance forward total
GUESTS	0	Guest # count
P/BAL	0	Previous balance count
	\$0.00	Previous balance total
CHECKS PAID	0	Checks Paid count
	\$0.00	Checks Paid total
SERVICE	0	Service count
	\$0.00	Service total
NOSALE	1	No sale counter

continued next page

Clerk Report Example, Continued

CLERK 02			(Sales information
CLERK 03			repeated for each of
CLERK 04			the fifteen clerks with
CLERK 05			sales activity)
CLERK 06			
CLERK 07			
CLERK 08			
CLERK 09			
CLERK 10			
CLERK 11			
CLERK 12			
CLERK 13			
CLERK 14			
CLERK 15			
CLERK 01	No.00001		Clerk/Consecutive #
TIME 12:00	00		Time/Register #

Cash-In-Drawer Report Example (Report #5)

DATE 08/15/2003	SUN	Date/Day
X 1 REPORT	0001	Report Mode/Z Counter

CASH-IN-DRAWER		Report Name
SALES AMT	\$141.70	Amount of cash
CLERK 01	No.00001	Clerk/Consecutive #
TIME 12:00	00	Time/Register #

Check-In-Drawer Report Example (Report #6)

DATE 08/15/2003	SUN	Date/Day
X 1 REPORT	0001	Report Mode/Z Counter

CHECK-IN-DRAWER		Report Name
CNT		Number of checks
SALES AMT	\$141.70	Amount of checks
CLERK 01	No.00001	Clerk/Consecutive #
TIME 12:00	00	Time/Register #

Food Stamp-In-Drawer Report Example (Report #7)

DATE 08/15/2003	SUN	Date/Day
X 1 REPORT	0001	Report Mode/Z Counter

FOOD-IN-DRAWER		Report Name
CNT		Number of food stamps
SALES AMT	\$141.70	Amount of food stamps
CLERK 01	No.00001	Clerk/Consecutive #
TIME 12:00	00	Time/Register #

Daily Sales Report Example (Report #8)

The register accumulates sales data until midnight of the each day. Days correspond to the day of the month kept by the register's calendar.

DATE 08/15/2003	SUN	Date/Day
X 2 REPORT	0001	Report Mode/Z Counter

DAILY SALES		Report Name
DAY : 1		1 st day of month
CNT	15	customer count
SALES AMT	\$90.64	net sales
DAY : 2		2 nd day of month
CNT	36	customer count
SALES AMT	\$100.56	net sales
TOTAL CNT	51	customer count all days
TOTAL AMT	\$191.20	net sales - all days
CLERK 01	No.00001	Clerk/Consecutive #
TIME 12:00	00	Time/Register #

Item by Group Report Example (Report #10)

This report organizes PLU sales by the group to which each PLU is reported. Because of the sorting involved in this report, there will be a noticeable delay while it is printing.

DATE 08/15/2003	SUN	Date/Day
X 1 REPORT	0002	Report Mode/Z Counter

ITEMS BY GROUP		Report Name
GROUP 0		Group number
PLU 1		PLU descriptor
CNT	33.00	count of sales
SALES AMT	\$67.77	sales amount
PLU 2		PLU descriptor
CNT	3.00	count of sales
SALES AMT	\$12.00	sales amount
PLU 3		PLU descriptor
CNT	6.00	count of sales
SALES AMT	\$17.50	sales amount
PLU 4		PLU descriptor
CNT	7.00	count of sales
SALES AMT	\$31.05	sales amount
PLU 116		PLU descriptor
CNT	1	count of sales
SALES AMT	\$6.00	sales amount
PLU 118		PLU descriptor
CNT	1	count of sales
SALES AMT	\$1.25	sales amount
PLU 510		PLU descriptor
CNT	6.00	count of sales
SALES AMT	\$28.67	sales amount
PLU 540		PLU descriptor
CNT	3	count of sales
SALES AMT	\$7.50	sales amount
TOTAL CNT	60.00	Total PLU count/amount
TOTAL AMT	\$171.74	for this group

continued next page

Item by Group Report Example, Continued

GROUP 1			(Totals repeated for
GROUP 2			each group set to
GROUP 3			accumulate PLU sales)
GROUP 4			
GROUP 5			
GROUP 6			
GROUP 7			
GROUP 8			
GROUP 9			
GROUP 10			
GROUP 11			
GROUP 12			
GROUP 13			
GROUP 14			
GROUP 15			
GROUP 16			
GROUP 17			
GROUP 18			
GROUP 19			
GROUP 20			

TOTAL CNT	60.00	Total PLU count/amount	
TOTAL AMT	\$171.74	for all groups	
CLERK 01	No.00001	Clerk/Consecutive #	
TIME 12:00	00	Time/Register #	

Open Table Report Example (Report #11)

DATE 08/15/2003	SUN	Date/Day
X 1 REPORT	0001	Report Mode/Z Counter

OPEN TABLE		Report Name
TABLE 2	\$0.00	Outstanding Balance and Clerk responsible for each open table
CLERK 1		
TABLE 45	\$0.00	
CLERK 1		
TABLE 49	\$0.00	
CLERK 2		
TABLE 56	\$0.00	
CLERK 2		
CLERK 01	No.00001	Clerk/Consecutive #
TIME 12:00	00	Time/Register #

Inventory PLU Report Example (Report #12)

This report reads the sales count for all PLUs where the sales counter is set to decrement (count down) for inventory level tracking. (To select this option, see "Program 100 - PLU Status Programming" on page 99 and set address N7). Remember, you can also read the sales counter on the other PLU reports, i.e. the All PLU report, the Item by Group report, and the From/To PLU report.

DATE 08/15/2003	SUN	Date/Day
X 1 REPORT	0001	Report Mode/Z Counter

STOCK		Report Name
PLU 1		PLU #
CNT	25.00	Current Inventory Level
PLU 2		
CNT	20.00	
PLU 3		
CNT	10.00	
PLU 4		
CNT	15.00	
PLU 5		
CNT	32.00	
PLU 6		
CNT	25.00	
PLU 7		
CNT	24.00	
PLU 8		
CNT	15.00	
PLU 9		
CNT	36.00	
CLERK 01	No.00001	Clerk/Consecutive #
TIME 12:00	00	Time/Register #

Group Report Example (Report #20)

Because each PLU can be reported to one or two groups, the total at the end of this report does not necessarily reflect the total of item sales. You can also program individual groups not to add to the total at the end of this report. See "Programming Group Status - Program 900" on page 152. Also note that you can choose to include groups with zero totals on this report (see option #3, "System Option Programming" on page 108.)

DATE 08/15/2003	SUN	Date/Day
X 1 REPORT	0001	Report Mode/Z Counter

GROUP		Report Name
GROUP0 :		Group #
CNT	60.00	Activity count
SALES AMT	\$171.84	Group total
TOTAL CNT	0.00	Count/total of all
TOTAL AMT	\$0.00	designated groups
CLERK 01	No.00001	Clerk/Consecutive #
TIME 12:00	00	Time/Register #

System Balancing

PLU Sales Total

+/-	PLU Sales	\$ Example
+	Positive PLUs	\$
-	Negative PLUs	\$
=	Adjusted PLU Sales Total	\$

Net Sales

+/-	Net Sales	\$ Example
=	PLU Sales Total	\$
+	Tax 1	\$
+	Tax 2	\$
+	Tax 3	\$
+	Sale Coupon Total	\$
+	Sale Percent Discount	\$
+	Surcharge Sale	\$
=	Net Sales	\$

Gross Sales

+/-	Gross Sales	\$ Example
=	Net Sales	\$
-	Negative PLUs	\$
-	Item Coupon	\$
-	Item Percent Discount	\$
-	Sale Coupon	\$
-	Sale Percent Discount	\$
-	Credit Tax 1	\$
-	Credit Tax 2	\$
-	Credit Tax 3	\$
-	Merchandise Return	\$
-	Transaction Void Total	\$
=	Gross Sales	\$

Grand Total

+/-	Grand Total	\$ Example
+	Previous Grand Total	\$
+	Absolute Value of Today's Gross Sales Total	\$
=	Today's Grand Total	\$

Programming

Overview

In this chapter you will find:

- "Function Key Assignment Programming" on page 91, where you can assign new functions in programmable locations or make other changes to the default keyboard.
- "Tax Programming" on page 93, where you can set tax rates or tables for any of the four taxes the *ER-5115* can automatically calculate and add to the sale.
- "PLU Programming" on page 97, where you can program descriptors and options, i.e. tax status for each keyboard PLU or traditional PLU.
- "System Option Programming" on page 108, where you can set a variety of options that affect the features of the *ER-5115*.
- "Function Key Programming" on page 109, where you can program descriptors and other options related to function keys.
- "Clerk Programming" on page 145 where you can program descriptors and other options for clerks or cashiers.
- "Miscellaneous Programming" on page 149, where you can program a variety of other features, such as receipt messages, date/time, PLU group descriptors, and PLU level operation.
- "Program Scans" on page 159 where you can print out program information.

S-mode, or service mode programming information is provided separately. S-mode programs allow you to change the keyboard PLU assignment or set keyboard PLU configurations for the *ER-5115*.

Default Program

The SAM4s *ER-5115* arrives with a default or generic program already installed. Program options are set to **0** (Zero), unless otherwise noted, which means the machine can be operated immediately after a RAM clear procedure is performed.

For example:

- All keyboard PLUs are nontaxable and open, without entry limits by default status programming of "00000000".
- All system options are set to **0** in default programming, unless otherwise noted. Change only the options that will deviate from default programming. There is no need to re-enter an option status of **0**, since **0** is its original setting.
- All programming (unless otherwise noted) is done with the control lock in the **P** position. Each section details a specific area of register programming.

Function Key Assignment Programming

Function keys may be relocated, inactivated or changed with this program. For example, you may wish to place functions, such as **PREVIOUS BALANCE** and **SERVICE**, which are not placed on the default keyboard. Or perhaps, you may wish to remove a function, such as **CANCEL**, for security reasons.

Please note the following limitations:

- If you assign a duplicate of a function code, the duplicate will function exactly as the original - you will not get separate totals and counters on reports for the duplicated key.
- You can reassign keys only in locations that are programmable. See "Keyboard" on page 20, where the key locations that may be programmed are identified.

To Assign a Function Key to a Location:

1. Turn the control lock to the **S** position.
2. Enter 20, press the **SBTL** key.

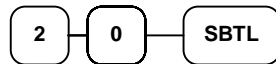

3. Refer to "Function Key Codes" on page 92 to find the code for the key you wish to assign. Enter the code, press the location you wish to program, or press **CASH** to cancel function key assignment programming.

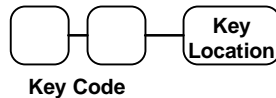

4. Repeat from step three for each key you wish to program, or press the same key to finalize the program.

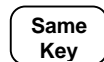

Function Key Codes

Code	Function	Code	Function
1	Cash	31	Eat In
2	Check	32	Take Out
3	Subtotal	33	Drive Thru
4	Macro 1	34	Received on Account
5	Macro 2	35	Paid Out
6	Macro 3	36	Clerk
7	Macro 4	37	#/No Sale
8	Macro 5	38	Scale
9	Charge 1	39	Food Stamp Shift
10	Charge 2	40	Food Stamp Subtotal
11	Charge 3	41	Food Stamp Tender
12	Charge 4	42	Check Cashing
13	Charge 5	43	Previous Balance
14	% 1	44	Table #
15	% 2	45	Guest #
16	% 3	46	Service
17	% 4	47	Check Endorsement
18	% 5	48	Tax Exempt
19	Level 1	49	Promo
20	Level 2	50	Waste
21	Level 3	51	Currency Conversion 1
22	Tax 1	52	Currency Conversion 2
23	Tax 2	53	PLU
24	Tax 3	54	X/TIME
25	Tax 4	55	Receipt On/Off
26	Error Correct	58	Inactive Key
27	Void		
28	Return		
29	Cancel		
30	Tray Subtotal		

Tax Programming

The *SAM4s ER-5115* has the capability to support four separate taxes.

Taxes can be calculated as either a straight percentage rate of between .001% and 99.999%, or a 60 break point tax table. Each tax may be either an add-on tax (added to the cost of a taxable item), or a value added tax (VAT) that is included in the price of the item.

Tax rate 4 may be set to function as the Canadian Goods & Services Tax (GST). **If Tax 4 is designated as GST, table programming for the rate is not allowed.**

Definitions for tax rates 1, 2, 3 & 4 are made as part of tax programming.

- If you are entering a tax rate (add-on or VAT), see "Straight Percentage Tax Rate Programming" on page 94 to enter the percentage rate.
- If you are entering a tax table, see "Tax Table Programming" on page 95 to enter the tax break points.
- If you are entering a Canadian Goods and Services Tax (GST), use tax rate 4 for the GST tax, and use tax rates 1, 2 and/or 3 for any other provincial tax or taxes. See "Straight Percentage Tax Rate Programming" on page 94 to enter the GST status and percentage rate.

Important Note: After you have entered your tax program(s), test for accuracy by entering several transactions of different dollar amounts. Carefully check to make sure the tax charged by the cash register matches the tax on the printed tax chart for your area. As a merchant, you are responsible for accurate tax collection. If the cash register is not calculating tax accurately, contact your *SAM4s* dealer for assistance.

Straight Percentage Tax Rate Programming

When tax requirements may be met using a straight percentage rate, use the following method to program a tax as a straight percentage.

Programming Straight Percentage Tax Rates and Status

1. Turn the control lock to the **P** position.
2. If the tax is a percentage rate, with a decimal. (0.000-99.999). It is not necessary to enter preceding zeros. For example, for 6%, enter 06.000 or 6.000.
3. For the type of tax:

If the tax is a percentage added to the sale (normal add on tax), enter:	0
If the tax is a percentage value added tax (VAT; calculated as part of the sale), enter:	2

4. Enter **0** here for all taxes, unless if you are programming tax 4 as a Canadian GST. If tax 4 is a Canadian GST, enter the sum of the options below:

OPTION	VALUE	=	SUM
GST (tax 4) is taxable by rate 1?	Yes = 1 No = 0		
GST (tax 4) is taxable by rate 2?	Yes = 2 No = 0		
GST (tax 4) is taxable by rate 3?	Yes = 4 No = 0		

6. Press the Tax Shift key for the tax you are programming.
7. Press the **CASH** key to end programming.

Tax Rate Programming Flowchart

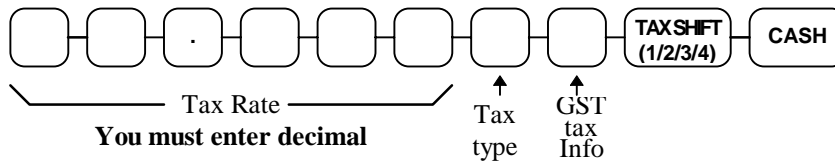

Tax Table Programming

In some cases, a tax that is entered as a percentage does not follow exactly the tax charts that apply in your area (even if the tax chart is based on a percentage). In these cases, we recommend that you enter your tax using tax table programming. This method will match tax collection exactly to the break points of your tax table.

Before programming, obtain a copy of the tax table you wish to program. You will need the printed tax table if you wish to determine the break point entries yourself.

Note: You can enter up to 60 break points.

Determining Break Point Entries

1. Examine the printed tax table for the tax you are programming.
2. Refer to the “Tax Table Programming Example - Illinois 6% Tax Table” on page 96 to help with this exercise.
3. Calculate the break point differences by subtracting the high side of the previous range from the high side of the dollar range.
4. Examine the pattern of break point differences to determine when the break points begin to repeat. Mark the beginning break points that do not fit a pattern as “non-repeat breaks.” Mark the break points that are repeating in a pattern as “repeat breaks.”

Programming a Tax Table

1. Turn the control lock to the **P** position.
2. Enter **10**, press the **TAX SHIFT** key for the tax you are programming, i.e. **TAX SHIFT 1**, **TAX SHIFT 2**, **TAX SHIFT 3** or **TAX SHIFT 4**.
3. Enter the maximum amount that is not taxed, press the appropriate **TAX SHIFT** key.
4. Enter the first tax amount charged, press the appropriate **TAX SHIFT** key.
5. For each non-repeat break point, up to the last non-repeat break point, enter the high side from the sale dollar range and press the appropriate **TAX SHIFT** key.
6. For the last non-repeat break point, enter the high side from the sale dollar range and press the **X/TIME** key.
7. For each repeat break point, enter the high side from the sale dollar range and press the appropriate **TAX SHIFT** key.
8. Press the **CASH** key to end the tax table program.

Tax Table Programming Example - Illinois 6% Tax Table

<u>Tax Charged</u>	<u>Sale Dollar Range</u>	<u>Break point Differences</u>	
\$0.00	\$0.00 - \$0.10		
\$0.01	\$0.11 - \$0.21	11	Non-Repeat
\$0.02	\$0.22 - \$0.38	17	
\$0.03	\$0.39 - \$0.56	18	
\$0.04	\$0.57 - \$0.73	17	
\$0.05	\$0.74 - \$0.91	18	
\$0.06	\$0.92 - \$1.08	17	Repeat
\$0.07	\$1.09 - \$1.24	16	
\$0.08	\$1.25 - \$1.41	17	
\$0.09	\$1.42 - \$1.58	17	
\$0.10	\$1.59 - \$1.74	16	
\$0.11	\$1.75 - \$1.91	17	
\$0.12	\$1.92 - \$2.08	17	
\$0.13	\$2.09 - \$2.24	16	
\$0.14	\$2.25 - \$2.41	17	

To enter the sample program for the Illinois 6% tax table in tax 1:

1. Enter **1 0** press the **TAX SHIFT 1** key.
2. Enter **1 0** (the maximum amount that is not taxed), press the **TAX SHIFT 1** key.
3. Enter **1** (the first tax amount charged), press the **TAX SHIFT 1** key.
4. Enter **2 1** (non-repeat break point), press the **TAX SHIFT 1** key.
5. Enter **3 8** (non-repeat break point), press the **TAX SHIFT 1** key.
6. Enter **5 6** (non-repeat break point), press the **TAX SHIFT 1** key.
7. Enter **7 3** (non-repeat break point), press the **TAX SHIFT 1** key.
8. Enter **9 1** (non-repeat break point), press the **X/TIME** key.
9. Enter **1 0 8** (repeat break point), press the **TAX SHIFT 1** key.
10. Enter **1 2 4** (repeat break point), press the **TAX SHIFT 1** key.
11. Enter **1 4 1** (repeat break point), press the **TAX SHIFT 1** key.
12. Press the **CASH** key to complete the tax program.

PLU Programming

All PLUs, whether they are registered by pressing a PLU key on the keyboard, or by entering the PLU number and pressing the **PLU** key, have the same programming options. These options are set through separate programs:

- Program 100 - PLU Status Programming determines whether the PLU is open, preset or inactive. Also selected here are tax, food stamp, scale, negative, single item, hash, gallonage, compulsory number entry, compulsory validation, compulsory condiment and print options.
- Program 150 - PLU Group Assignment allows you to select up to two groups where each PLUs sales will accumulate.
- Program 200 - PLU Price/HALO Programming determines the PLU price if the PLU is preset, or the high amount lock out (HALO) if the PLU is open.
- Program 250 - PLU Stock Amount Programming allows you to add stock to the PLU sales counters for PLUs you have designated as stock keeping PLUs.
- Program 300 - PLU Descriptor Programming allows you to set a unique, up to 12-character, descriptor for each PLU.
- Program 400 - PLU Link Programming allows you to link a PLU to another PLU, so that registration of the first PLU will automatically trigger registration of the linked PLU.

PLU Number Assignment for Keyboard PLUs and PLU Levels

PLUs have fixed numbers from 1 to 1000. In the standard configuration, keyboard PLUs access the following PLU numbers 1-15.

If level keys are used:

- Level 1 accesses PLUs 1-15
- Level 2 accesses PLUs 16-30
- Level 3 accesses PLUs 31-45

An optional numbering method is available for PLUs and Levels. (See your *SAM4s* dealer or the *SAM4s ER-5115 S-Mode Programming* instructions for set-up details.) You may wish to consider this option when you are using pop-up levels for sizes and you want different sizes of the same item to be listed together on the PLU report. With this option selected:

- PLU #1 accesses PLU 1 on level 1, PLU 2 on level 2, and PLU 3 on level 3
 - PLU #2 accesses PLU 4 on level 1, PLU 5 on level 2, and PLU 6 on level 3
 - PLU #3 accesses PLU 7 on level 1, PLU 8 on level 2, and PLU 9 on level 3,
- and so on until:
- PLU #15 accesses PLU 43 on level 1, PLU 44 on level 2 and PLU 45 on level 3

Program 100 - PLU Status Programming

1. Turn the control lock to the **P** position.
2. To begin the program, enter **1 0 0**, press the **SBTL** key.



3. Select the PLU or PLUs you wish to program in one of the following ways:

- Press a PLU key on the keyboard, or

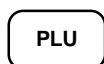

- Press multiple PLU keys that are to receive the same status, or



- Press a level key, then an PLU key, or



- Enter the number of the PLU (1-1000) and press the **PLU** key, or



- Enter the number (1-1000) of the first PLU in a range of PLUs that are to receive the same setting; press the **PLU** key. Enter the last number (1-1000) in the range; press the **PLU** key.



4. Refer to the "PLU Status Chart" on page 100 to determine the values for **N1** through **N8**. (If an address offers more than one option, add the values for each option and enter the sum. For example, if you wish the PLU to be taxable by rates 1 and 3, add the values for your choices, 1 + 4, and enter the sum "5" for address N5.) Enter the values you have selected, press the **X/TIME** key. (**You do not need to enter preceding zeros**. For example, if you are only selecting a value for **N8**, i.e. taxable by tax 1, just enter **1**.)

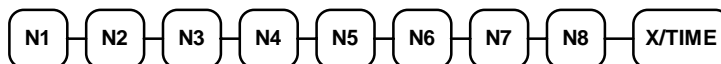

5. To program additional PLUs, repeat from step 3, or press the **CASH** key to finalize the program.

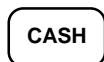

Program 150 - PLU Group Assignment

Each PLU may report to any two of 21 groups. Group totals appear on reports, so that you can track sales of different types of items. A group can also be used to designate items that are to print on an optional kitchen printer.

Note: The PLU will report to group "0", if not programmed to report to groups 1-20.

1. Turn the control lock to the **P** position.
2. To begin the program, enter **1 5 0**, press the **SBTL** key.

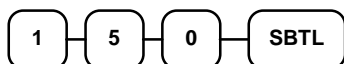

3. Select the PLU or PLUs you wish to program in one of the following ways:

- Press a PLU key on the keyboard, or

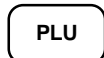

- Press multiple PLU keys that are to receive the same status, or



- Press a level key, then an PLU key, or



- Enter the number of the PLU (1-1000) and press the **PLU** key, or



- Enter the number (1-1000) of the first PLU in a range of PLUs that are to receive the same setting; press the **PLU** key. Enter the last number (1-1000) in the range; press the **PLU** key.



4. Enter up to two 2-digit numbers representing the groups where you wish to add the PLUs sales, i.e. enter **1 0** for group ten or enter **0 4** for group four. Press the **X/TIME** key. Note that the 1st group assignment will also determine kitchen printer routing.



1st Group 2nd Group
(for KP routing)

5. To program additional PLUs, repeat from step 3, or press the **CASH** key to finalize the program.



Program 200 - PLU Price/HALO Programming

If a PLU is open, set the HALO (high amount lock out) here. If a PLU is preset set the preset price here. If a PLU is set with gallonage status, enter the price per gallon here. (Enter price per gallon in tenths of a penny, i.e. 1299 for \$1.29 9/10 per gallon.)

1. Turn the control lock to the **P** position.
2. To begin the program, enter **2 0 0**, press the **SBTL** key.

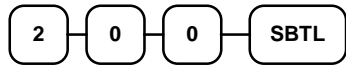

3. Select the PLU or PLUs you wish to program in one of the following ways:

- Press a PLU key on the keyboard, or



- Press multiple PLU keys that are to receive the same status, or



- Press a level key, then an PLU key, or



- Enter the number of the PLU (1-1000) and press the **PLU** key, or



- Enter the number (1-1000) of the first PLU in a range of PLUs that are to receive the same setting; press the **PLU** key. Enter the last number (1-1000) in the range; press the **PLU** key.



4. If the PLU is open, enter a HALO of up to 8 digits. If the PLU is preset, enter a preset price. (The maximum HALO or preset price you can enter is \$500,000.00.) Press the **X/TIME** key.



Price/HALO

5. To program additional PLUs, repeat from step 3, or press the **CASH** key to finalize the program.

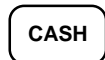

Program 250 - PLU Stock Amount Programming

With this program, you can add stock to the PLU sales counters for PLUs you have designated as stock keeping PLUs. See "Program 100 - PLU Status Programming" on page 99 to set up stock keeping PLUs. The stock number set here can be the amount of stock that is being added to the current level, or optionally, it can be the new total stock level. See option #40 in "System Option Programming" on page 108 to set this option.

1. Turn the control lock to the **P** position.
2. To begin the program, enter **2 5 0**, press the **SBTL** key.

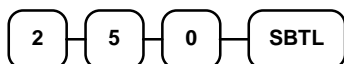

3. Select the PLU or PLUs you wish to program in one of the following ways:

- Press a PLU key on the keyboard, or

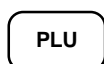

- Press multiple PLU keys that are to receive the same status, or



- Press a level key, then an PLU key, or



- Enter the number of the PLU (1-1000) and press the **PLU** key, or



- Enter the number (1-1000) of the first PLU in a range of PLUs that are to receive the same setting; press the **PLU** key. Enter the last number (1-1000) in the range; press the **PLU** key.



4. Enter the stock amount you wish to add (up to four digits), press the **X/TIME** key.



Stock Amount

5. To program additional PLUs, repeat from step 3, or press the **CASH** key to finalize the program.

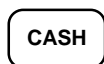

Program 300 - PLU Descriptor Programming

1. Turn the control lock to the **P** position.
2. To begin the program, enter **3 0 0**, press the **SBTL** key.

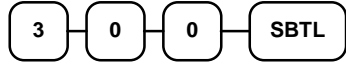

3. Select the PLU you wish to program in one of the following ways:

- Press a PLU key on the keyboard, or

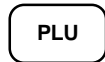

- Press a level key, then an PLU key, or



- Enter the number of the PLU (1-1000) and press the **PLU** key, or



5. Refer to the "Descriptor Code Chart" on page 105 and determine the codes for the descriptor you wish to program. Enter up to 12 three-character codes; press the **X/TIME** key.

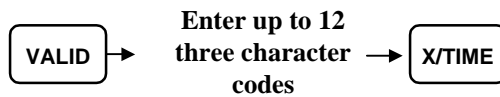

6. To program additional PLUs, repeat from step 3, or press the **CASH** key to finalize the program.



Descriptor Code Chart

CHAR	SPACE	!	"	#	\$	%	&	'	()
CODE	032	033	034	035	036	037	038	039	040	041
CHAR	*	+	,	-	.	/	0	1	2	3
CODE	042	043	044	045	046	047	048	049	050	051
CHAR	4	5	6	7	8	9	:	;	<	=
CODE	052	053	054	055	056	057	058	059	060	061
CHAR	>	?	@	A	B	C	D	E	F	G
CODE	062	063	064	065	066	067	068	069	070	071
CHAR	H	I	J	K	L	M	N	O	P	Q
CODE	072	073	074	075	076	077	078	079	080	081
CHAR	R	S	T	U	V	W	X	Y	Z	
CODE	082	083	084	085	086	087	088	089	090	091
CHAR						a	b	c	d	e
CODE	092	093	094	095	096	097	098	099	100	101
CHAR	f	g	h	I	i	k	l	m	n	o
CODE	102	103	104	105	106	107	108	109	110	111
CHAR	p	q	r	s	t	u	v	w	x	y
CODE	112	113	114	115	116	117	118	119	120	121
CHAR	z	□	Double							
CODE	122	123	999							

Program 400 - PLU Link Programming

PLU link programming allows you to link a PLU to another PLU, so that registration of the first PLU will automatically trigger registration of the linked PLU. For example, you may wish to link a bottle deposit with the sale of beverages, or you may wish to register a group of items normally sold together.

1. Turn the control lock to the **P** position.
2. To begin the program, enter **4 0 0**, press the **SBTL** key.

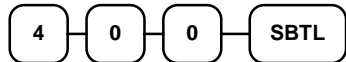

3. Select the PLU or PLUs you wish to program in one of the following ways:

- Press a PLU key on the keyboard, or

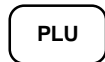

- Press a level key, then an PLU key, or



- Enter the number of the PLU (1-1000) and press the **PLU** key, or



4. Enter the number (1-1000) of the PLU you wish the PLU linked to; press the PLU key. Or press the PLU key on the keyboard you wish the PLU linked to.



5. To program additional PLUs, repeat from step 3, or press the **CASH** key to finalize the program.



Delete PLU Links

1. Turn the control lock to the **P** position.
2. To begin the program, enter **4 0 0**, press the **SBTL** key.

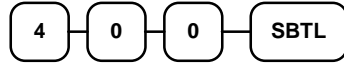

3. Select the PLU or PLUs you wish to program in one of the following ways:

- Press a PLU key on the keyboard, or



- Press a level key, then an PLU key, or



- Enter the number of the PLU (1-1000) and press the **PLU** key, or



4. Enter **0** and press the PLU key.



5. To program additional PLUs, repeat from step 3, or press the **CASH** key to finalize the program.



System Option Programming

Refer to the “System Option Table” on page 109 to review the system options. Read each option carefully to determine if you wish to make any changes.

NOTE: Because after clearing memory all options settings are automatically set to 0, and because your most likely option selections require a status setting of 0, you do not need to program this section unless you wish to change the default status.

Programming a System Option:

1. Turn the control lock to the **P** position.
2. Enter **3 0**, press the **SBTL** key.
3. Enter a system option address, press the **X/TIME** key.
4. Enter the number representing the status you have selected, or if there is more than one decision to be made in an address, add the values representing your choices for each decision and enter the sum. Press the **SBTL** key.
5. Repeat from step 3 for each system option you wish to change.
6. Press the **CASH** key to end system option programming.

System Option Flowchart

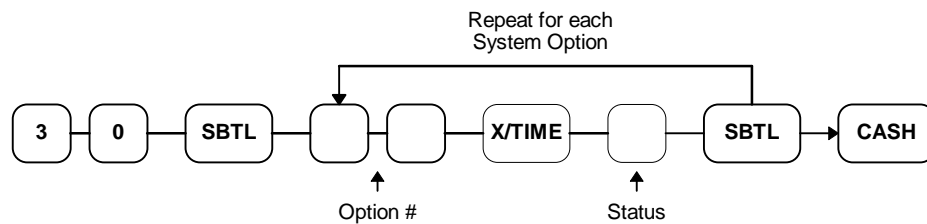

System Option Table

Address	SYSTEM OPTION	VALUE	=	SUM
1	Cash declaration is compulsory before X or Z Financial report may be taken?	Yes = 1 No = 0		
	Cash drawer will not open when cash is declared?	Yes = 2 No = 0		
	Cash drawer will not open when reports are run?	Yes = 4 No = 0		
2	Grand total is not printed on the Financial report?	Yes = 1 No = 0		
3	Skip media totals with zero activity on the Financial report?	Yes = 0 No = 1		
	Print abbreviated Financial report?	Yes = 2 No = 0		
	Print media totals with zero activity on the Group report?.	Yes = 4 No = 0		
4	Consecutive number is reset after a Z1 Financial report?	Yes = 1 No = 0		
	Grand total is reset after a Z1 Financial report?	Yes = 2 No = 0		
5	Print Group report at the beginning of the Financial report?	Yes = 1 No = 0		
	Print Clerk report at the end of the Financial report?	Yes = 2 No = 0		
6	Print PLUs with zero totals on report?	Yes = 1 No = 0		
	Print percentage of sales on the PLU report?	Yes = 2 No = 0		
7	Skip media totals with zero activity on the Clerk report?	Yes = 0 No = 1		
	Clerk report includes media totals?	Yes = 2 No = 0		
8	Gross total will not print on the Financial report?	Yes = 1 No = 0		
	Void/Return totals will not print on the Financial report?	Yes = 2 No = 0		
9	Reset the Financial report Z counter after a Z1 Financial report?	Yes = 1 No = 0		
	Reset the Time report Z counter after a Z1 Time report?	Yes = 2 No = 0		
	Reset the PLU report Z counter after a Z1 PLU report?	Yes = 4 No = 0		

Address	SYSTEM OPTION	VALUE	=	SUM
10	Reset the Clerk report Z counter after a Z1 Clerk report?	Yes = 1 No = 0		
	Reset the Daily Sales report Z counter after a Z1 Daily Sales report?	Yes = 2 No = 0		
	Reset the Group report Z counter after a Z1 Group report?	Yes = 4 No = 0		
11	Do not print Z counter on reports?	Yes = 1 No = 0		
	Do not print consecutive number counter on receipt or journal?	Yes = 2 No = 0		
	Print date of last Z report on Z reports.	Yes = 0 No = 4		
12	Do not print time on receipt and journal?	Yes = 1 No = 0		
	Do not print date on receipt and journal?	Yes = 2 No = 0		
	Do not print register number on receipt and journal?	Yes = 4 No = 0		
13	Date format for receipt, journal and validation printing: DD-MM-YY = MM-DD-YY =	1 0		
14	Decimal print and display: no decimal = decimal in second position =	1 0		
15	Clerks are: pop-up = stay down =	1 0		
	Clerk sign on method is: code entry = direct entry =	2 0		
16	Currency character is: selected code from descriptor code chart = \$ =	code 0		
17	Compulsory drawer is disabled?	Yes = 1 No = 0		
	Validation sensor is activated?	Yes = 2 No = 0		
	Paper sensor is enabled?	Yes = 4 No = 0		
18	Open drawer alarm is active?	Yes = 1 No = 0		
19	The number of seconds before the open drawer warning tone sounds (default is 30 seconds).	0-99		

Address	SYSTEM OPTION	VALUE	=	SUM
29	Rounding for split pricing and decimal multiplication: round up at 0.005 = always round up = always round down =	0 1 2		
30	Stamp and Logo printing on receipt: Print only stamp = Print stamp and preamble message = Print only preamble message =	0 1 2		
31	Print postamble message on receipt?	Yes = 1 No = 0		
	Print preamble on the guest check?	Yes = 2 No = 0		
	Print postamble on the guest check?	Yes = 4 No = 0		
32	Training mode enter = exit =	1 0		
	Do not print training mode message on the receipt during training mode operations?	Yes = 2 No = 0		
	Open cash drawer during training mode?	Yes = 0 No = 4		
33	Allow the post tender function?	Yes = 1 No = 0		
	Compulsory check endorsement?	Yes = 2 No = 0		
	Print check amount in the endorsement?	Yes = 4 No = 0		
34	Level key is active and level function is: stay down = pop-up after item entry = pop-up after sale is finalized =	0 1 2		
35	Disable level keys Level 1 = Level 2 = Level 3 =	1 2 4		
36	Allow direct multiplication of keyboard PLUs? (This automatically disables preset override.)	Yes = 1 No = 0		
37	Eat-in/Take-out/Drive Thru procedure compulsory before tendering is allowed?	Yes = 1 No = 0		
38	HASH PLU adds to NET sales?	Yes = 1 No = 0		

Address	SYSTEM OPTION	VALUE	=	SUM
39	Allow any clerk to recall open table numbers?	Yes = 1 No = 0		
	Service total prints on guest check?	Yes = 2 No = 0		
	Default level inactive?	Yes = 4 No = 0		
40	Inventory (stock) counter programming: inventory is added to current level =	1 0		
41	Auto Clear Active?	Yes = 1 No = 0		
	Print Negative Grand Total on Financial report?	Yes = 2 No = 0		
42	Slip (hard check) operation on optional printer	0		
	Kitchen printer operation on optional printer	1		
43	Printer type: no printer = EPSON TM-295 = SAMSUNG SRP-270 = SAMSUNG SRP-350 = CITIZEN IDP 3540/3541 = STAR SP200 = SAMSUNG SRP-100 = INTERNAL R/J Printer =	0 1 2 3 4 5 6 7		
44	Number of feed lines after printing on optional roll printer? (Default is 7 lines.)	1-50		
45	Initial line feed on optional slip printer	0-20		
46	Number of print lines on a guest check	0-50		
47	Measure used for Gallonage PLUs:	LTR = 1 GAL = 0		
	Condiment entry allowed any time during a transaction:	Yes = 2 No = 0		
48	Pole Display attached =	1		
	Liquor Interface attached =	2		
	Remote Journal attached =	3		
49	Waste affects item count?	Yes = 1 No = 0		
50	Print Preamble Message on Journal = 1 Print Postamble message on Journal = 2			

Function Key Programming

Three programs are used to program function keys;

- *Program 70* - is used to set each keys individual options
- *Program 80* - is used to program a 12 character alpha numeric descriptor
- *Program 90* - is used to set a high amount limit (HALO)

In this chapter you will find:

- General instructions for programs 70, 80 and 90.
- Specific programming instructions for each function key.

Function Key Programming Summary

The table below summarizes the function keys programmed here and the programs that apply to each key:

Function Key	Function Key Options Program 70	Function Key Descriptor Program 80	Function Key HALO Program 90
CANCEL	✓	✓	
CASH	✓	✓	✓
CHARGE	✓	✓	✓
CHECK	✓	✓	✓
CHECK ENDORSEMENT			
CHECK CASH	✓	✓	✓
CURRENCY CONVERSION		✓	✓
DRIVE THRU	✓	✓	
EAT-IN	✓	✓	
ERROR CORRECT	✓	✓	
FOOD STAMP TENDER	✓	✓	✓
GUEST	✓	✓	
#/NO SALE	✓	✓	✓
PREVIOUS BALANCE	✓	✓	
PROMO	✓	✓	
P/O	✓	✓	✓
R/A	✓	✓	✓
RETURN	✓	✓	
SCALE	✓		
SERVICE		✓	
TABLE	✓	✓	
TAKE OUT	✓	✓	
TAX EXEMPT	✓		
TRAY SUBTOTAL	✓	✓	
VOID	✓	✓	
WASTE	✓	✓	
% KEY	✓	✓	✓

Program 70 - Function Key Options

Use Program 70 to set options for function keys. Because of the differences inherent in function keys, individual options will be different. See the specific instructions for each key in this chapter to find the options for each key.

1. Turn the control lock to the **P** position.
2. To begin the program, enter **7 0**, press the **SBTL** key.

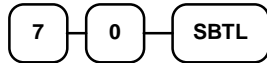

4. Enter the values for the option digit or digits. Depending on the function key you are programming, you may enter up to five digits **N1** through **N5**. Determine the values for **N1** through **N5** by referring to the specific function key information that follows. (**You do not need to enter preceding zeros**. For example, if the function key offers five digits, **N1** through **N5** and you are only selecting a value for **N5**, just enter the value for **N5**.) Press the function key you wish to program.

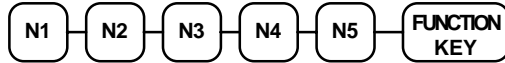

5. To program additional function keys, repeat from step 3, or press the **CASH** key to finalize the program.

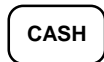

Program 80 - Function Key Descriptor

Use Program 80 to program alphanumeric descriptors for function keys. Descriptors can be up to 12 characters in length. (Because the **#/NS** key supports two functions, program 81 is used to program the non-add **#** function, while program 80 is used to program the no sale function. See individual function programming instructions in this chapter.)

1. Turn the control lock to the **P** position.
2. To begin the program, enter **8 0**, press the **SBTL** key.

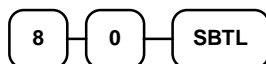

4. Refer to the "Descriptor Code Chart" on page 117 and determine the codes for the descriptor you wish to program. Enter up to 12 three-character codes; then press the function key you are programming. Repeat this step to program additional function keys.

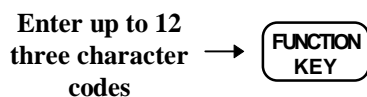

5. Press the **CASH** key to finalize the program.



Descriptor Code Chart

CHAR	SPACE	!	"	#	\$	%	&	'	()
CODE	032	033	034	035	036	037	038	039	040	041
CHAR	*	+	,	-	.	/	0	1	2	3
CODE	042	043	044	045	046	047	048	049	050	051
CHAR	4	5	6	7	8	9	:	;	<	=
CODE	052	053	054	055	056	057	058	059	060	061
CHAR	>	?	@	A	B	C	D	E	F	G
CODE	062	063	064	065	066	067	068	069	070	071
CHAR	H	I	J	K	L	M	N	O	P	Q
CODE	072	073	074	075	076	077	078	079	080	081
CHAR	R	S	T	U	V	W	X	Y	Z	
CODE	082	083	084	085	086	087	088	089	090	091
CHAR						a	b	c	d	e
CODE	092	093	094	095	096	097	098	099	100	101
CHAR	f	g	h	I	i	k	l	m	n	o
CODE	102	103	104	105	106	107	108	109	110	111
CHAR	p	q	r	s	t	u	v	w	x	y
CODE	112	113	114	115	116	117	118	119	120	121
CHAR	z	•	Double							
CODE	122	123	999							

Program 90 - Function Key HALO

Use Program 90 to program a high amount lock out (HALO) for a function key. Only specific keys require this program. For example, you can set a HALO for the **CASH**, **CHECK** or **CHARGE** keys. Refer to the specific function key programming information in this chapter to determine when the HALO option is available.

Note: An 8 digit HALO has a maximum entry of \$500,000.00.

1. Turn the control lock to the **P** position.
2. To begin the program, enter **9 0**, press the **SBTL** key.

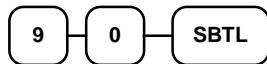

3. Enter a HALO of up to eight digits, (or "0" for no HALO).

**Enter 1-8 digit
HALO**

4. Press the function key on the keyboard you wish to program.



5. To program additional function keys, repeat from step 2, or press the **CASH** key to finalize the program.



#/No Sale - Function Key Programs

Options - Program 70

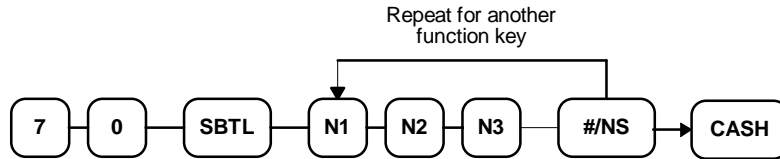

Address	OPTION	VALUE	=	SUM
N1	Compulsory non-add entry must match number of digits set in HALO programming?	Yes = 1 No = 0		
N2	No Sale inactive after non-add # entry?	Yes = 1 No = 0		
	Enforce non-add # entry at start of sale?	Yes = 2 No = 0		
	Non-add # entries are prohibited?.	Yes = 4 No = 0		
N3	No Sale inactive?	Yes = 1 No = 0		
	No Sale active in X control lock position only?	Yes = 2 No = 0		
	Validation compulsory on No Sale?	Yes = 4 No = 0		

Descriptor - Programs 80 & 81

Since two distinct functions, # entry and no sale, reside on the same key, different programs are used to program each descriptor.

To program the no sale descriptor:

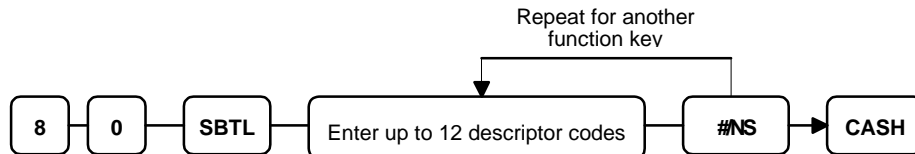

To program the # descriptor:

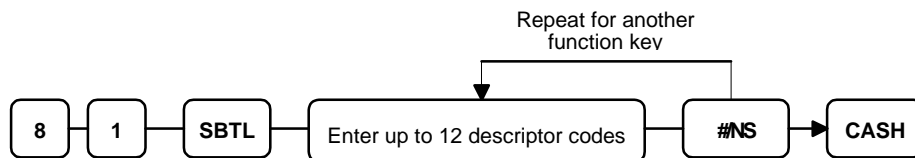

HALO - Program 90

You can set the number of digits allowed for the non-add entry function of the **#/NS** key.

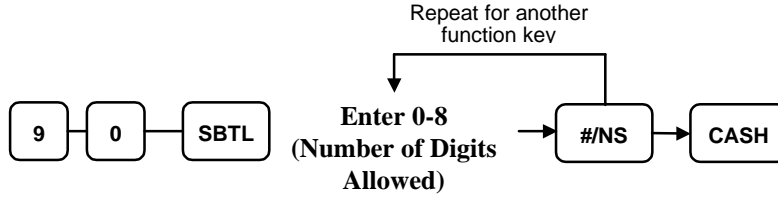

Cancel - Function Key Programs

Options - Program 70

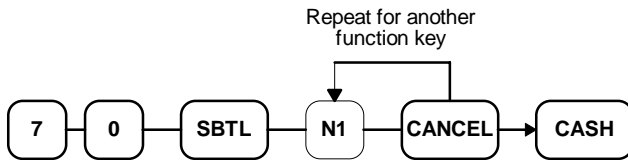

Address	OPTION	VALUE	=	SUM
N1	Key is inactive?	Yes = 1 No = 0		
	Key in active in X control lock position only?	Yes = 2 No = 0		
	Validation compulsory?	Yes = 4 No = 0		

Descriptor - Program 80

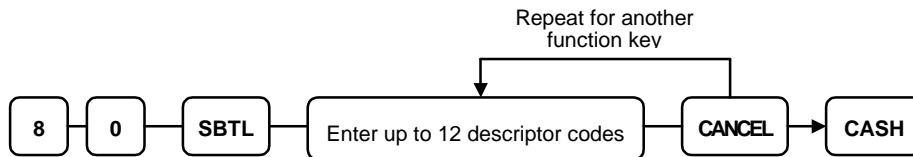

Cash - Function Key Programs

Options - Program 70

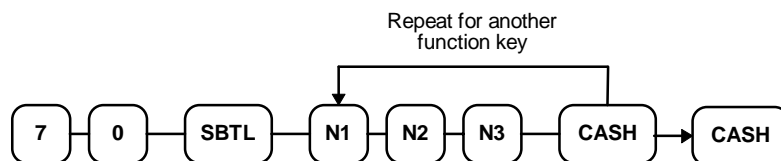

Address	OPTION	VALUE	=	SUM
N1	Exempt tax 1?	Yes = 1 No = 0		
	Exempt tax 2?	Yes = 2 No = 0		
	Exempt tax 3?	Yes = 4 No = 0		
N2	Exempt tax 4?	Yes = 1 No = 0		
	Open cash drawer?	Yes = 0 No = 2		
	Validation is compulsory?	Yes = 4 No = 0		
N3	Amount tender is compulsory?	Yes = 1 No = 0		
	Disable under tendering?	Yes = 2 No = 0		
	Allow over tendering and under tendering in X control lock position only?	Yes = 4 No = 0		

Descriptor - Program 80

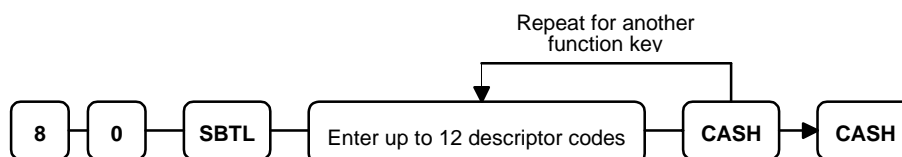

HALO - Program 90

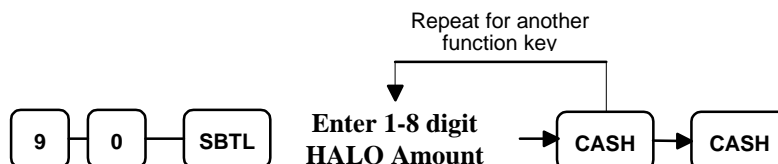

Charge - Function Key Programs

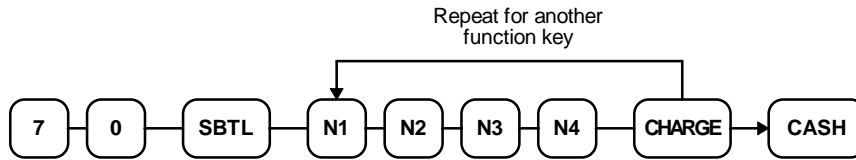

Address	OPTION	VALUE	=	SUM
N1	Non-add # entry compulsory?	Yes = 1 No = 0		
	Allow over tendering?	Yes = 2 No = 0		
N2	Exempt tax 1?	Yes = 1 No = 0		
	Exempt tax 2?	Yes = 2 No = 0		
	Exempt tax 3?	Yes = 4 No = 0		
N3	Exempt tax 4?	Yes = 1 No = 0		
	Open cash drawer?	Yes = 0 No = 2		
	Validation is compulsory?	Yes = 4 No = 0		
N4	Amount tender is compulsory?	Yes = 1 No = 0		
	Disable under tendering?	Yes = 2 No = 0		
	Allow over tendering and under tendering in X control lock position only?	Yes = 4 No = 0		

Descriptor - Program 80

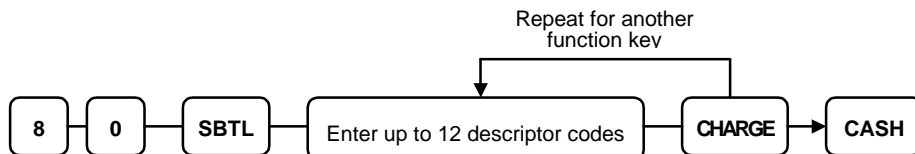

HALO - Program 90

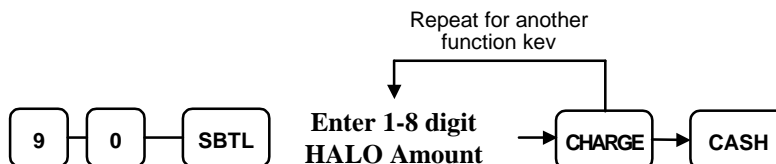

Check - Function Key Programs

Options - Program 70

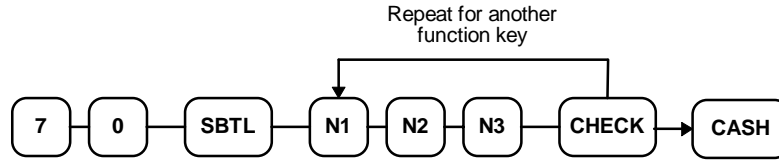

Address	OPTION	VALUE	=	SUM
N1	Exempt tax 1?	Yes = 1 No = 0		
	Exempt tax 2?	Yes = 2 No = 0		
	Exempt tax 3?	Yes = 4 No = 0		
N2	Exempt tax 4?	Yes = 1 No = 0		
	Open cash drawer?	Yes = 0 No = 2		
	Validation is compulsory?	Yes = 4 No = 0		
N3	Amount tender is compulsory?	Yes = 1 No = 0		
	Disable under tendering?	Yes = 2 No = 0		
	Allow over tendering and under tendering in X control lock position?	Yes = 4 No = 0		

Descriptor - Program 80

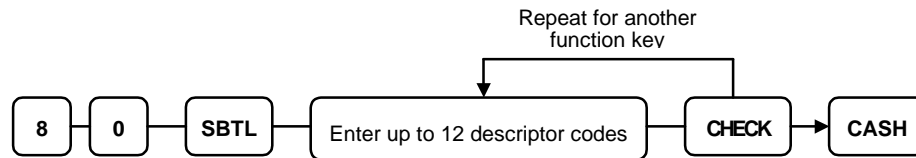

HALO - Programs 90 and 91

Check Tender HALO - Program 90

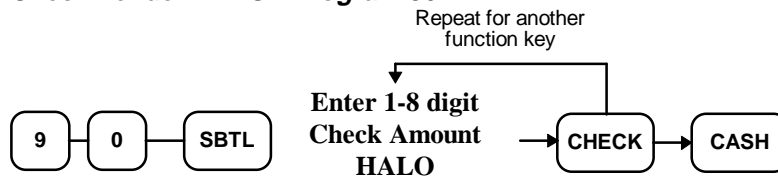

Check Change HALO - Program 91

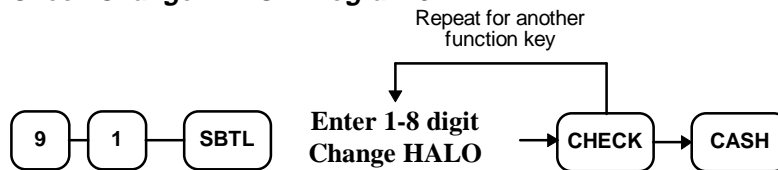

Check Cashing - Function Key Programs

Options - Program 70

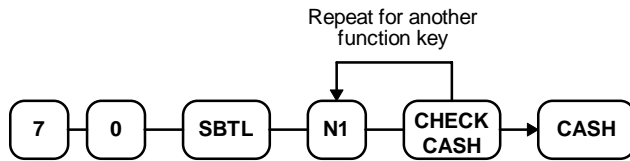

Address	OPTION	VALUE	=	SUM
N1	Key is inactive?	Yes = 1 No = 0		
	Key in active in X control lock position only?	Yes = 2 No = 0		
	Validation compulsory?	Yes = 4 No = 0		

Descriptor - Program 80

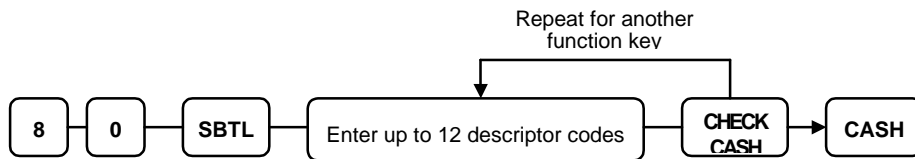

HALO - Program 90

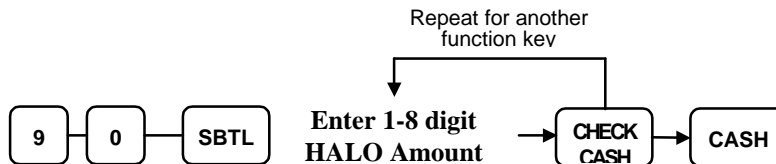

Currency Conversion - Function Key Programs

Descriptor - Program 80

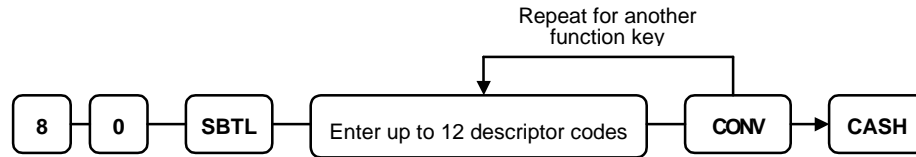

Currency Conversion Rate - Program 90

1. Turn the control lock to the **P** position.
2. To begin the program, enter **9 0**, press the **SBTL** key.

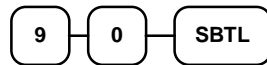

3. Enter the exchange rate of up to 5 digits (do not enter the decimal point), then enter a number from 0 to 4 to indicate the decimal position. See "Currency Exchange Rate Programming Examples" below.

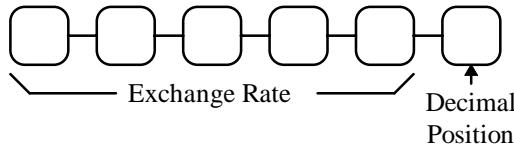

4. Press the function key on the keyboard you wish to program.



5. To program additional function keys, repeat from step 2, or press the **CASH** key to finalize the program.



Currency Exchange Rate Programming Examples

Note: Foreign currency exchange rates may be stated as “foreign currency in dollars”, or “dollars in foreign currency”. Use the rate stated in “dollars in foreign currency” when you are programming this section.

The US dollar (home currency) is worth 1.3720 Canadian dollars (foreign currency).

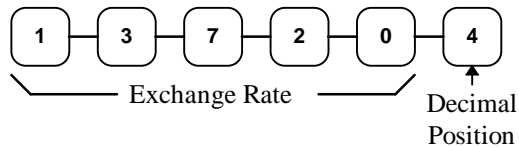

The US dollar (home currency) is worth 110.24 Japanese Yen (foreign currency).

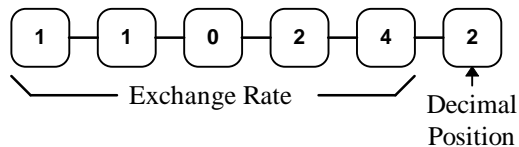

Drive Thru - Function Key Programs

Options - Program 70

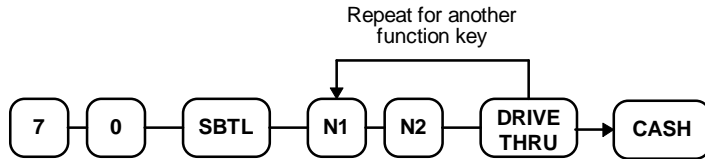

Address	OPTION	VALUE	=	SUM
N1	Exempt tax 1?	Yes = 1 No = 0		
	Exempt tax 2?	Yes = 2 No = 0		
	Exempt tax 3?	Yes = 4 No = 0		
N2	Exempt tax 4?	Yes = 1 No = 0		
	Validation is compulsory?	Yes = 2 No = 0		

Descriptor - Program 80

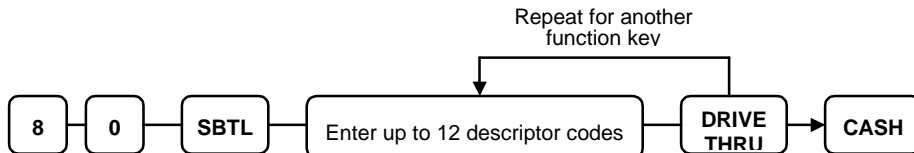

Eat-In - Function Key Programs

Options - Program 70

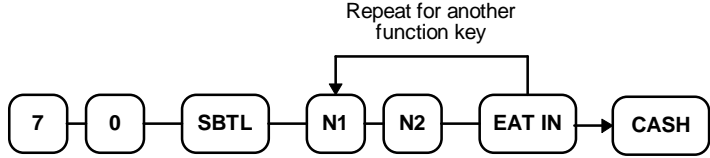

Address	OPTION	VALUE	=	SUM
N1	Exempt tax 1?	Yes = 1 No = 0		
	Exempt tax 2?	Yes = 2 No = 0		
	Exempt tax 3?	Yes = 4 No = 0		
N2	Exempt tax 4?	Yes = 1 No = 0		
	Validation is compulsory?	Yes = 2 No = 0		

Descriptor - Program 80

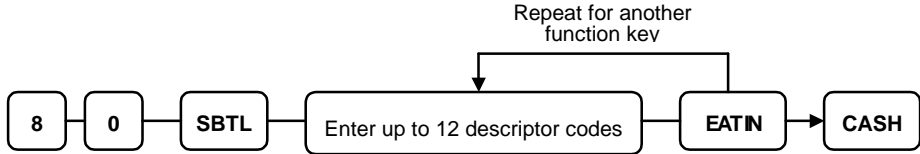

Error Correct - Function Key Programs

Options - Program 70

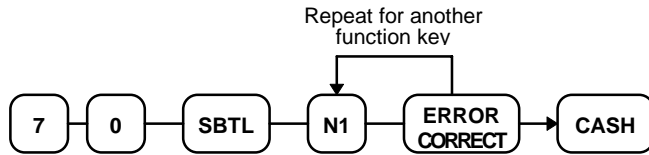

Address	OPTION	VALUE	=	SUM
N1	Key is inactive?	Yes = 1 No = 0		
	Key in active in X control lock position only?	Yes = 2 No = 0		
	Validation compulsory?	Yes = 4 No = 0		

Descriptor - Program 80

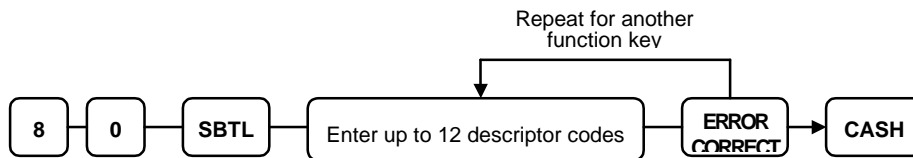

Food Stamp Tender - Function Key Programs

Options - Program 70

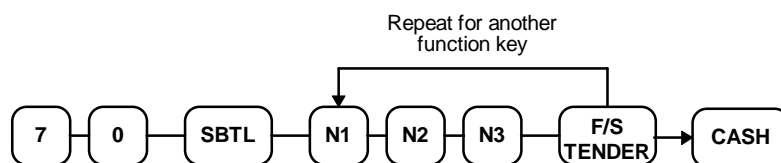

Address	OPTION	VALUE	=	SUM
N1	Exempt tax 1?	Yes = 1 No = 0		
	Exempt tax 2?	Yes = 2 No = 0		
	Exempt tax 3?	Yes = 4 No = 0		
N2	Exempt tax 4?	Yes = 1 No = 0		
	Allow decimal entry?	Yes = 2 No = 0		
	Food stamp change is issued in: cash = food stamps =	4 0		
N3	Open cash drawer?	Yes = 0 No = 1		

Descriptor - Program 80

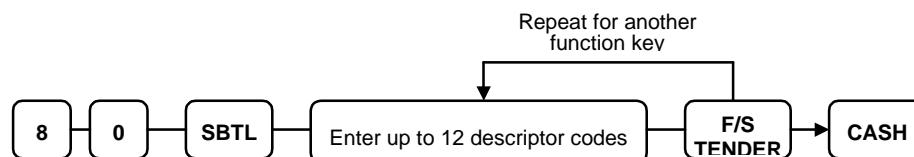

HALO - Program 90

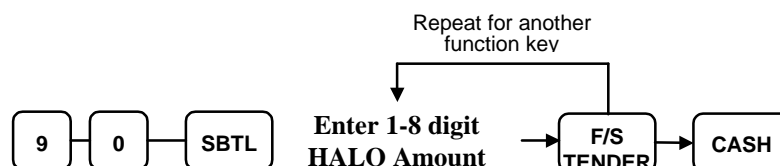

Guest # - Function Key Programs

Options - Program 70

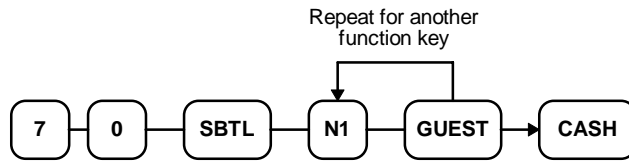

Address	OPTION	VALUE	=	SUM
N1	Guest # compulsory when you use guest check operation?	Yes = 1 No = 0		

Descriptor - Program 80

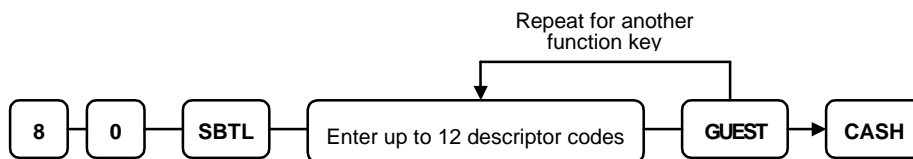

Previous Balance - Function Key Programs

Options - Program 70

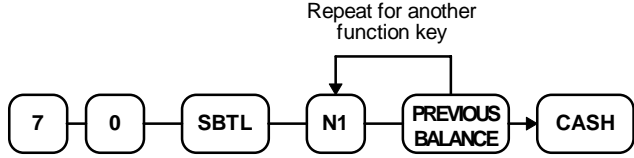

Address	OPTION	VALUE	=	SUM
N1	Previous balance may be entered at any time?	Yes = 1 No = 0		
	Previous balance required at the start of the sale?	Yes = 2 No = 0		

Descriptor - Program 80

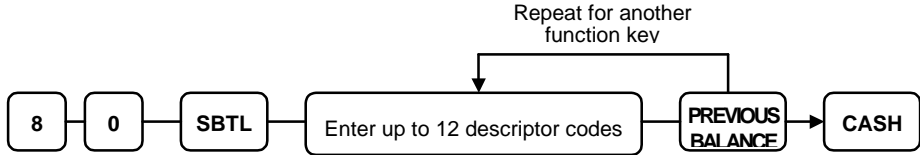

Promo - Function Key Programs

Options - Program 70

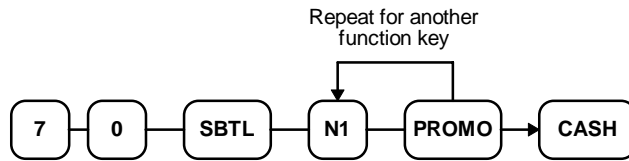

Address	OPTION	VALUE	=	SUM
N1	Key is inactive?	Yes = 1 No = 0		
	Key in active in X control lock position only?	Yes = 2 No = 0		
	Validation compulsory?	Yes = 4 No = 0		

Descriptor - Program 80

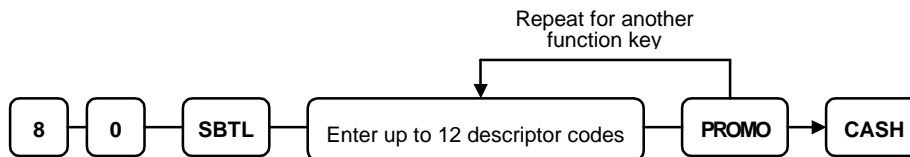

Paid Out - Function Key Programs

Options - Program 70

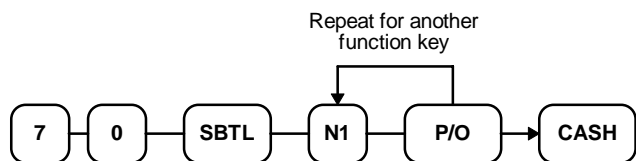

Address	OPTION	VALUE	=	SUM
N1	Key is inactive?	Yes = 1 No = 0		
	Key in active in X control lock position only?	Yes = 2 No = 0		
	Validation compulsory?	Yes = 4 No = 0		

Descriptor - Program 80

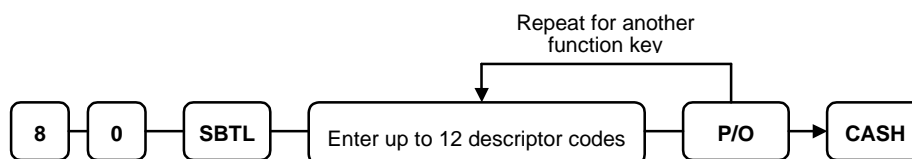

HALO - Program 90

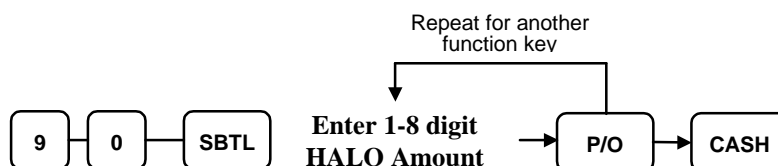

Received on Account - Function Key Programs

Options - Program 70

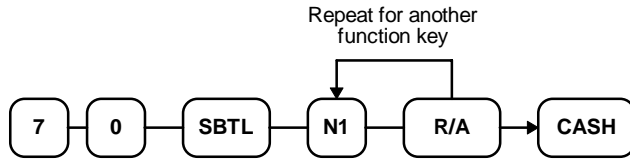

Address	OPTION	VALUE	=	SUM
N1	Key is inactive?	Yes = 1 No = 0		
	Key in active in X control lock position only?	Yes = 2 No = 0		
	Validation compulsory?	Yes = 4 No = 0		

Descriptor - Program 80

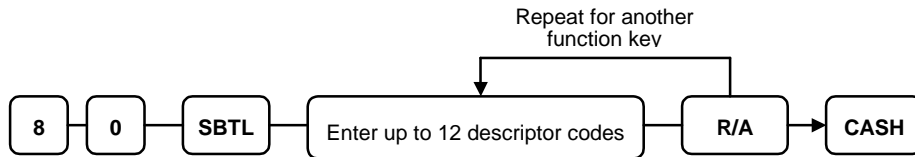

HALO - Program 90

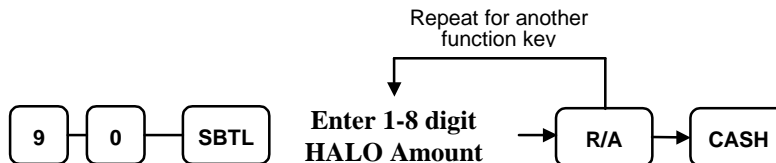

Return - Function Key Programs

Options - Program 70

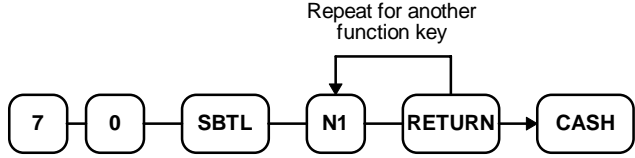

Address	OPTION	VALUE	=	SUM
N1	Key is inactive?	Yes = 1 No = 0		
	Key in active in X control lock position only?	Yes = 2 No = 0		
	Validation compulsory?	Yes = 4 No = 0		

Descriptor - Program 80

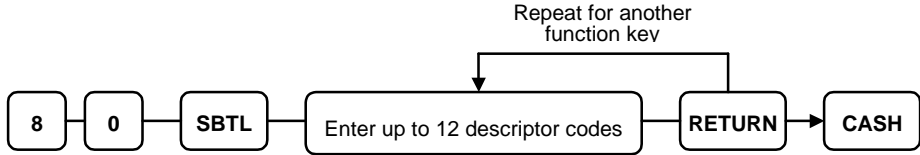

Scale - Function Key Programs

Options - Program 70

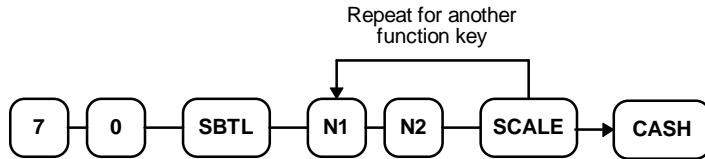

Address	OPTION	VALUE	=	SUM
N1	Weight symbol for manual entry is:	kg=1 lb=0		
N2	Key is inactive?	Yes = 1 No = 0		
	Key in active in X control lock position only?	Yes = 2 No = 0		
	Allow manual entry of weight?	Yes = 4 No = 0		

Service - Function Key Programs

Descriptor - Program 80

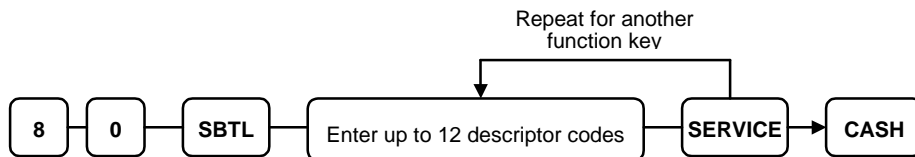
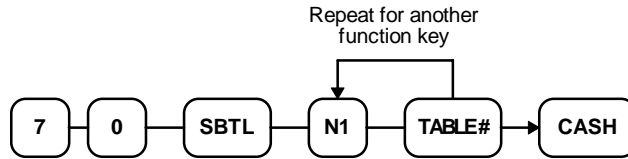

Table # - Function Key Programs

Options - Program 70



Address	OPTION	VALUE	=	SUM
N1	Table number entry compulsory for all sales?	Yes = 1 No = 0		

Descriptor - Program 80

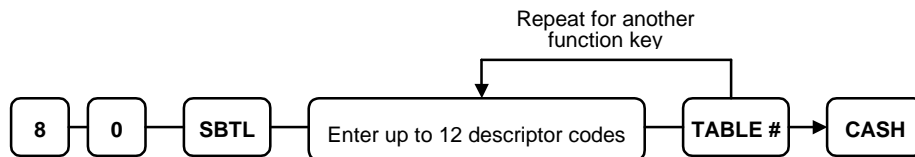

Take Out - Function Key Programs

Options - Program 70

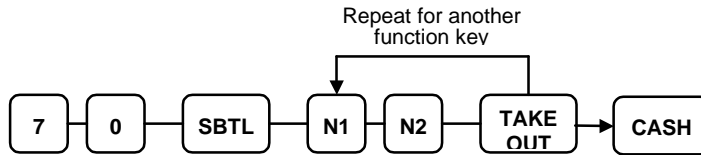

Address	OPTION	VALUE	=	SUM
N1	Exempt tax 1?	Yes = 1 No = 0		
	Exempt tax 2?	Yes = 2 No = 0		
	Exempt tax 3?	Yes = 4 No = 0		
N2	Exempt tax 4?	Yes = 1 No = 0		
	Validation is compulsory?	Yes = 2 No = 0		

Descriptor - Program 80

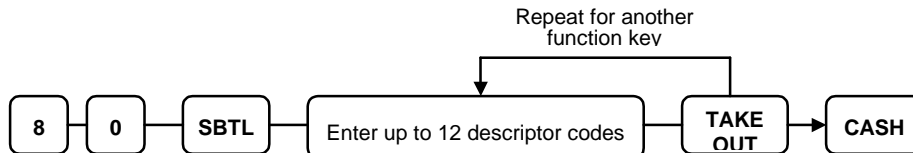

Tax Exempt - Function Key Programs

Options - Program 70

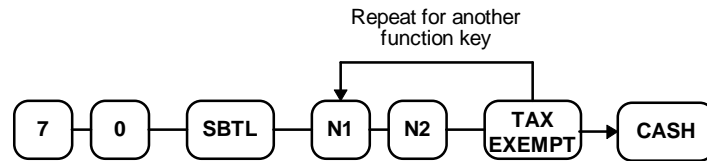

Address	OPTION	VALUE	=	SUM
N1	Exempt tax 1?	Yes = 1 No = 0		
	Exempt tax 2?	Yes = 2 No = 0		
	Exempt tax 3?	Yes = 4 No = 0		
N2	Exempt tax 4?	Yes = 1 No = 0		

Tray Subtotal - Function Key Programs

Options - Program 70

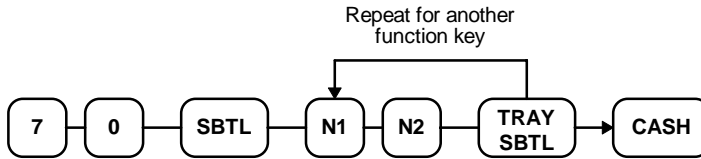

Address	OPTION	VALUE	=	SUM
N1	Print separate receipts for each tray?	Yes = 1 No = 0		
N2	Compulsory before tendering?	Yes = 1 No = 0		
	Validation is compulsory?	Yes = 2 No = 0		
	Consecutive number does not advance in tray subtotal operation? (Advances at final tender only.)	Yes = 4 No = 0		

Descriptor - Program 80

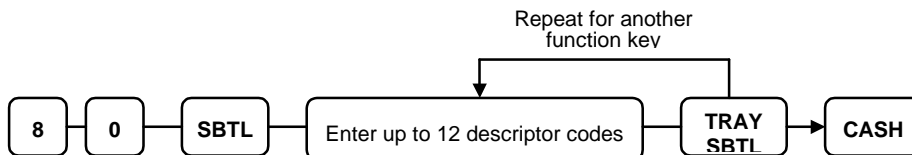

Void - Function Key Programs

Options - Program 70

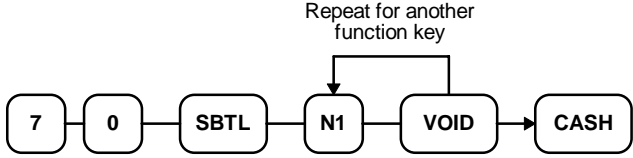

Address	OPTION	VALUE	=	SUM
N1	Key is inactive?	Yes = 1 No = 0		
	Key in active in X control lock position only?	Yes = 2 No = 0		
	Validation compulsory?	Yes = 4 No = 0		

Descriptor - Program 80

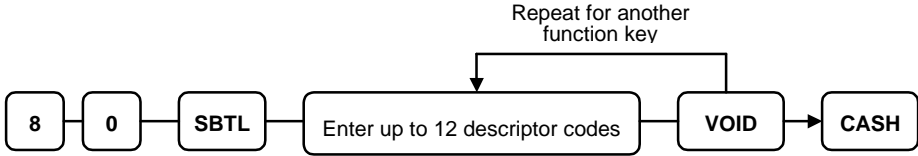

Waste - Function Key Programs

Options - Program 70

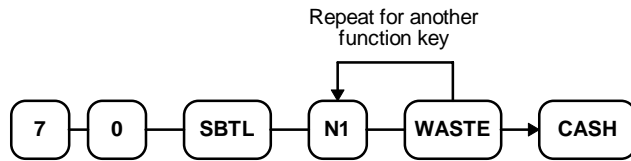

Address	OPTION	VALUE	=	SUM
N1	Key is inactive?	Yes = 1 No = 0		
	Key in active in X control lock position only?	Yes = 2 No = 0		
	Validation compulsory?	Yes = 4 No = 0		

Descriptor - Program 80

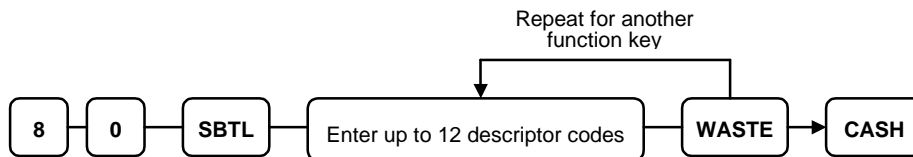

Descriptor - Program 80

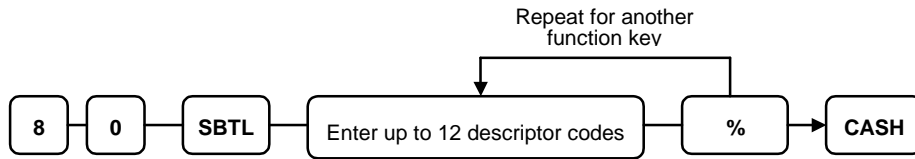

Percentage or HALO - Program 90

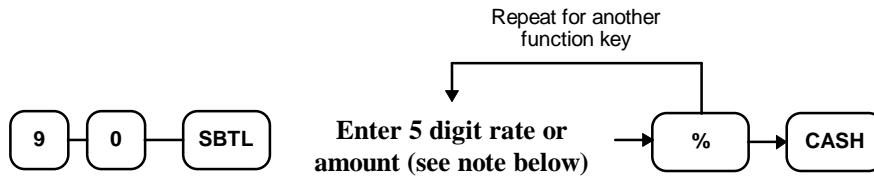

Note: If key is amount , enter 5 digit HALO, or 0 for no HALO. If key is percentage enter the percentage in a five-digit format, without the decimal (XX.XXX). For example: for 10%, enter 10000; for 5.55%, enter 05550; for 99.999%, enter 99999.

Clerk Programming

Clerks (which may be used as cashiers), have the following programming options. These options are set through separate programs:

- *Program 800 - Secret Code programming* determines the code that is used for clerk sign on if a code entry sign on method is selected in system option #15 (See "System Option Programming" on page 108.)
- *Program 801* - If a second cash drawer is installed, *Drawer Assignment* determines which cash drawer will be opened for each.
- *Program 810 - Clerk Descriptor Programming* allows you to set a unique, up to 12 character, descriptor for each clerk

Program 800 - Secret Code Programming

1. Turn the control lock to the **P** position.
2. To begin the program, enter **8 0 0**, press the **SBTL** key.

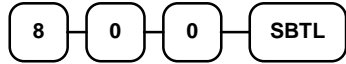

3. Enter the number (**1-15**) of the clerk you wish to program; press the **X/TIME** key.



4. Enter a secret code (up to 6 digits); press the **SBTL** key.

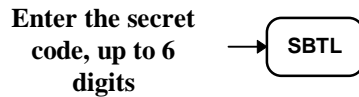

5. Repeat from step 3 for each clerk you wish to program. Press the **CASH** key to finalize the program.



Program 801 - Drawer Assignment

1. Turn the control lock to the **P** position.
2. To begin the program, enter **8 0 1**, press the **SBTL** key.

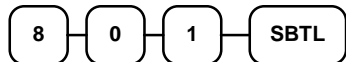

3. Enter the number (**1-15**) of the clerk you wish to program; press the **X/TIME** key.



4. Enter the drawer assignment (**0** (no drawer), **1** (default), or **2**); press the **SBTL** key.



5. Repeat from step 3 for each clerk you wish to program. Press the **CASH** key to finalize the program.

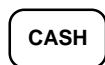

Program 810 - Clerk Descriptor Programming

- 1. Turn the control lock to the **P** position.
- 2. To begin the program, enter **8 1 0**, press the **SBTL** key.

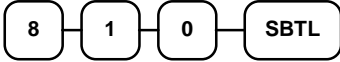

- 3. Enter the number (**1-15**) of the clerk you wish to program; press the **X/TIME** key.

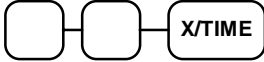

- 4. Refer to the "Descriptor Code Chart " on page 148 and determine the codes for the descriptor you wish to program. Enter up to 12 three-character codes; then press the **SBTL** key. Repeat from step 3 to program additional clerks.

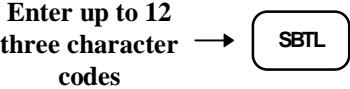

- 5. Press the **CASH** key to finalize the program.



Descriptor Code Chart

CHAR	SPACE	!	"	#	\$	%	&	'	()
CODE	032	033	034	035	036	037	038	039	040	041
CHAR	*	+	,	-	.	/	0	1	2	3
CODE	042	043	044	045	046	047	048	049	050	051
CHAR	4	5	6	7	8	9	:	;	<	=
CODE	052	053	054	055	056	057	058	059	060	061
CHAR	>	?	@	A	B	C	D	E	F	G
CODE	062	063	064	065	066	067	068	069	070	071
CHAR	H	I	J	K	L	M	N	O	P	Q
CODE	072	073	074	075	076	077	078	079	080	081
CHAR	R	S	T	U	V	W	X	Y	Z	
CODE	082	083	084	085	086	087	088	089	090	091
CHAR						a	b	c	d	e
CODE	092	093	094	095	096	097	098	099	100	101
CHAR	f	g	h	I	i	k	l	m	n	o
CODE	102	103	104	105	106	107	108	109	110	111
CHAR	p	q	r	s	t	u	v	w	x	y
CODE	112	113	114	115	116	117	118	119	120	121
CHAR	z	□	Double							
CODE	122	123	999							

Miscellaneous Programming

Program 95 - Macro Key Sequence Programming

Macros are special function keys that are used to execute a sequence of key depressions. For example, a macro might be used to execute a string of reports or to automatically tender a preset amount. Up to five different macros may be placed on the keyboard. (See "Function Key Assignment Programming" on page 91 to place macros on the keyboard.)

To Program a Macro

1. Turn the control lock to the **P** position.
2. To begin the program, enter **9 5**, press the **SBTL** key.

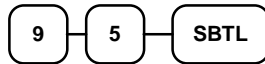

3. Press the **Macro** key that you wish to program.



4. Press up to 50 keystrokes that you wish the macro to execute, press the same **Macro** key to end the sequence. Note that you are allowed to enter a different macro key as part a macro key sequence.

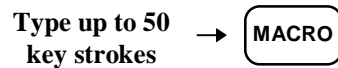

Receipt/Check Endorsement Message Programming

A preamble message of up to four lines can be printed at the top of each receipt; a postamble message of up to four lines can be printed at the bottom of each receipt. Each line can consist of up to twenty-one characters.

Programming the Receipt/Check Endorsement Message

1. Turn the control lock to the **P** position.
2. To begin the program, enter **7 0 0**, press the **SBTL** key.

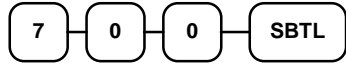

3. Refer to the chart below and enter the number that represents the line you wish to program; press the **X/TIME** key.

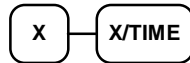

X	Message Line	X	Message Line
1	1 st line of Preamble	9	1 st line of Endorsement
2	2 nd line of Preamble	10	2 nd line of Endorsement
3	3 rd line of Preamble	11	3 rd line of Endorsement
4	4 th line of Preamble	12	4 th line of Endorsement
5	1 st line of Postamble	13	5 th line of Endorsement
6	2 nd line of Postamble	14	6 th line of Endorsement
7	3 rd line of Postamble	15	7 th line of Endorsement
8	4 th line of Postamble	16	8 th line of Endorsement

4. Refer to the "Descriptor Code Chart " on page 151 and determine the codes for the descriptor you wish to program. Enter up to 21 three-character codes; then press the **SBTL** key. Repeat from step 3 to program additional message lines.

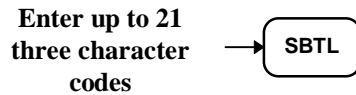

5. Press the **CASH** key to finalize the program.

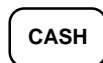

Descriptor Code Chart

CHAR	SPACE	!	"	#	\$	%	&	'	()
CODE	032	033	034	035	036	037	038	039	040	041
CHAR	*	+	,	-	.	/	0	1	2	3
CODE	042	043	044	045	046	047	048	049	050	051
CHAR	4	5	6	7	8	9	:	;	<	=
CODE	052	053	054	055	056	057	058	059	060	061
CHAR	>	?	@	A	B	C	D	E	F	G
CODE	062	063	064	065	066	067	068	069	070	071
CHAR	H	I	J	K	L	M	N	O	P	Q
CODE	072	073	074	075	076	077	078	079	080	081
CHAR	R	S	T	U	V	W	X	Y	Z	
CODE	082	083	084	085	086	087	088	089	090	091
CHAR						a	b	c	d	e
CODE	092	093	094	095	096	097	098	099	100	101
CHAR	f	g	h	I	i	k	l	m	n	o
CODE	102	103	104	105	106	107	108	109	110	111
CHAR	p	q	r	s	t	u	v	w	x	y
CODE	112	113	114	115	116	117	118	119	120	121
CHAR	z	□	Double							
CODE	122	123	999							

Group Status and Descriptor Programming

21 Group totals are available to accumulate totals of individual PLUs that are assigned to each group. Each PLU can be assigned to one or two different groups. (See "Program 150 - PLU Group Assignment" on page 101 to program PLU groups for each PLU.)

- Use program 900 to assign a group status, i.e. a group can be set to *not add* to the total of all groups, or a group can be used to designate like items for kitchen printer assignment.
- Use program 910 to assign a unique descriptor for each group, so that the group may be easily understood on the group report.

Programming Group Status - Program 900

1. Turn the control lock to the **P** position.
2. To begin the program, enter **9 0 0**, press the **SBTL** key.

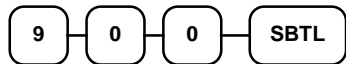

3. Enter the number (**1-20**) of the group you wish to program; press the **X/TIME** key.



4. Enter an option digit from the table below, press the **SBTL** key.

OPTION	VALUE	=	SUM
This group does not add to the group total?	Yes = 1 No = 0		
This group is a kitchen printer group?	Yes = 2 No = 0		

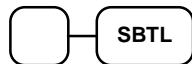

5. To program additional groups, repeat from step 3, or press the **CASH** key to finalize the program.

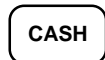

Programming Group Descriptors

1. Turn the control lock to the **P** position.
2. To begin the program, enter **9 1 0**, press the **SBTL** key.

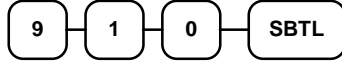

3. Enter the number (**1-20**) of the group you wish to program; press the **X/TIME** key.

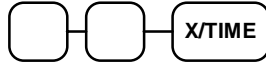

4. Refer to the "Descriptor Code Chart " on page 151 on and determine the codes for the descriptor you wish to program. Enter up to 12 three-character codes; then press the **SBTL** key. Repeat from step 3 to program additional group descriptors.

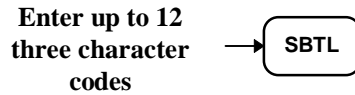

5. To program additional groups, repeat from step 3, or press the **CASH** key to finalize the program.



Scale Tare Weight Programming

A tare is the amount of weight accounted for by the container or packaging. By entering a tare weight (as required by law in some areas) the weight of the container is subtracted and only the true weight of the product is measured on the scale. If you are using an optional scale you can pre-program up to four standard tare weights. Tare #5 is reserved for manually entering tare weights. By using a tare, you automatically subtract the container weight when a product is on the scale.

1. Turn the control lock to the **P** position.
2. To begin the program, enter **1 1 0 0**, press the **SBTL** key.

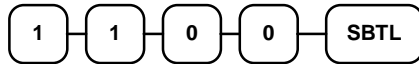

3. Enter the number (**1-4**) of the tare you wish to program; press the **X/TIME** key.

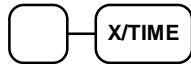

4. Enter the weight of the tare (one digit preceding the decimal key, the decimal key, then three digits after the decimal key). Press the **SBTL** key.



5. To program additional tare weights, repeat from step 3, or press the **CASH** key to finalize the program.



Drawer Limit Programming

You can set the total amount of cash and checks allowed to be in cash drawer at one time. (When the limit is equaled or exceeded, the error tone will sound at the completion of each transaction. You can clear the error to continue operations, or you can use the Paid Out function to remove enough cash or checks to reduce the drawer total below the limit set here.)

Programming the Drawer Limit

1. Turn the control lock to the **P** position.
2. To begin the program, enter **1 2 0 0**, press the **SBTL** key.

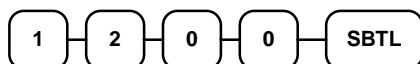

3. Enter a drawer limit (up to 8 digits or **0** for no limit); press the **X/TIME** key.

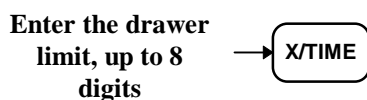

4. Press the **CASH** key to finalize the program.

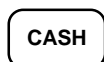

Machine Number Programming

You can set a machine number to print on the receipt and journal paper. If you have multiple registers or stores, use this number to identify the machine where the transaction took place.

Programming the Machine Number

1. Turn the control lock to the **P** position.
2. To begin the program, enter **1 3 0 0**, press the **SBTL** key.

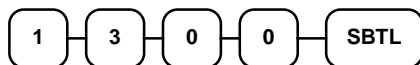

3. Enter a machine number (up to 2 digits); press the **X/TIME** key.

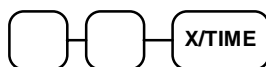

4. Press the **CASH** key to finalize the program.

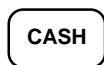

Default Level Programming

The default level is the "top" or "surface" level returned to after each PLU entry when options are set for Pop-up levels.

Programming the Default Level

1. Turn the control lock to the **X**, **Z** or the **P** position.
2. Press the level key twice.



Level Programming Example

Set the surface level to level 2:

1. Turn the control lock to the **X**, **Z** or the **P** position.
2. Press the level **2** key twice.



Date and Time Programming

The *SAM4s ER-5115* features a battery maintained 24-hour clock and calendar with the date and day changing automatically. However, from time to time it may be necessary to change either the time or the date.

Programming the Date, Day of Week and Time

The date sequence is Month-Day-Year.

1. Turn the control lock to the **P** position.
2. To begin the program, enter **1 4 0 0**, press the **SBTL** key.

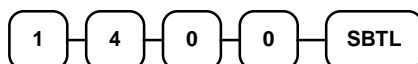

3. Enter the date and day of week using the chart below; press the **SBTL** key:



Value	Week Day
0	Sunday
1	Monday
2	Tuesday
3	Wednesday
4	Thursday
5	Friday
6	Saturday

4. Enter time in military standard time (based on 24 hours) , must be four digits (i.e. 1300 hours = 1:00 PM); press the **X/TIME** key.



5. Press the **CASH** key to finalize the program.



PC Schedule Operation Programming

The register must be in a ready condition before a PC can connect to it. You can program the register to enter the ready condition automatically at a set time, or you can enter or exit the ready condition manually.

Setting the Time for Automatic PC Connection

1. Turn the control lock to the **P** position.
2. To begin the program, enter **1 0 0 0**, press the **SBTL** key.

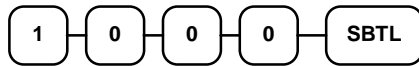

3. Enter the time in 24-hour (military time) format (enter 9999 for inactive operation); press the **X/TIME** key.

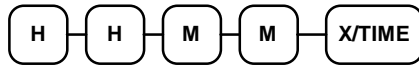

4. Press the **CASH** key to finalize the program.



Entering the PC Ready Mode Manually

1. Turn the control lock to the **Z** position.
2. Press the **CLERK** key.



Exiting the PC Ready Mode Manually

1. Press the **CLEAR** key.



Program Scans

Since much time and energy has been invested in the planning and programming of your *SAM4s ER-5115*, it is advisable to print a hard copy of the final program for future reference. This copy should be kept in a safe place.

1. Turn the control lock to the **P** position.
2. To print a program scan, enter **1 5**, press the **SBTL** key.

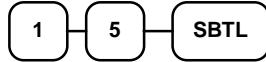

3. Refer to the chart below and enter a digit to represent the segment of the program you wish to print; press the **X/TIME** key.

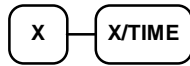

X	Program
1	Tax
2	Individual Function Key (press same key to exit)
3	Clerk
4	Group Descriptor
5	Receipt message
6	System option, Default level & drawer limit
7	Function key location
8	Macro

4. To read PLU program information, enter the number (1-1000) of the first PLU in a range of PLUs that are to be scanned; press the **PLU** key. Enter the last number (1-1000) in the range; press the **PLU** key.



Or, press the first PLU key on the keyboard to be scanned, then press the last PLU key on the keyboard to be scanned



5. To read additional parts of the program, repeat from step 3, or press the **CASH** key to finalize the program.

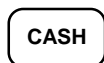

PLU Program Scan

DATE 08/15/2003 SUN	Date/Day

PLU SCAN	TYPE OF READOUT

PLU 1	PLU number
STATUS T1 00000001	Tax status/status
LINK GROUP 00 00	groups sales reported to
HALO AMT @0.00	High amount limit or preset amount
CNT 33.00	Activity count or inventory count
CLERK 01 No.00001	Clerk/Consecutive #
TIME 12:00 00	Time/Register #

Tax Program Scan

DATE 08/15/2003	SUN	Date/Day

TAX SCAN		TYPE OF READOUT

**** TAX 1 TABLE ****		Tax table readout
NON TAX AMT	\$0.10	lowest non tax amount
FIRST TAX AMT	\$0.01	first tax amount charged

POINT VALUE	\$0.11	Differences between non repeating breakpoints (calculated by the register)
POINT VALUE	\$0.17	
POINT VALUE	\$0.18	
POINT VALUE	\$0.17	
POINT VALUE	\$0.18	

POINT VALUE	\$0.17	Differences between repeating breakpoints
POINT VALUE	\$0.16	
POINT VALUE	\$0.17	
STATUS	10	Tax status
TAX 2	%10.000	Tax rate readout
STATUS	0	Tax status
TAX 3	%10.000	
STATUS	0	
TAX 4	%10.000	
STATUS	0	
CLERK 01	No.00001	Clerk/Consecutive #
TIME 12:00	00	Time/Register #

Function Key Program Scan

DATE 08/15/2003	SUN	Date/Day

FUNC.PGM.SCAN		TYPE OF READOUT

CASH	0	Descriptor/status
HALO	\$0.00	High amount lock out
CLERK 01	No.00001	Clerk/Consecutive #
TIME 12:00	00	Time/Register #

Clerk Program Scan

DATE 08/15/2003	SUN	Date/Day

CLERK PGM.SCAN		TYPE OF READOUT

CLERK1: SAM		Clerk #/Name
SECRET CODE	0	Secret code
DRAWER	1	Drawer assignment
CLERK1: ANNA		Clerk #/Name
SECRET CODE	0	Secret code
DRAWER	1	Drawer assignment
		(Readout continues for each of the 15 clerks)
CLERK 01	No.00001	Clerk/Consecutive #
TIME 12:00	00	Time/Register #

Group Descriptor Program Scan

<pre> DATE 08/15/2003 SUN ----- GROUP PGM SCAN ----- GROUP0 : 0 GROUP1 :DRINKS 0 GROUP2 : 0 GROUP3 : 0 GROUP4 : 0 CLERK 01 No.00001 TIME 12:00 00 </pre>	<pre> Date/Day ----- TYPE OF READOUT ----- Group # Group status Group #/Descriptor Group status Group #/Descriptor Group status Group #/Descriptor Group status Group #/Descriptor Group status (Readout continues for each of the 21 groups) Clerk/Consecutive # Time/Register # </pre>
--	--

Receipt Message Program Scan

DATE 08/15/2003 SUN	Date/Day

PRE/POST MSG.SCAN	TYPE OF READOUT

THE SANSUNG ER-5115 ELECTRONIC CASH REGISTER	4 - line preamble
THANK YOU FOR SHOPPING	2 - line postamble
FOR DEPOSIT ONLY ACCT# 1234567890 THE STORE, INC.	up to 10 line endorsement message
CLERK 01 No.00001	Clerk/Consecutive #
TIME 12:00 00	Time/Register #

System Option/Default level/ Drawer Limit/Tare Scan

DATE 08/15/2003 SUN	Date/Day

SYSTEM OPN SCAN	TYPE OF READOUT

SYSTEM OPN 1 0	Option #/status
SYSTEM OPN 2 0	Option #/status
SYSTEM OPN 3 0	Option #/status
SYSTEM OPN 4 0	Option #/status
SYSTEM OPN 5 0	Option #/status
SYSTEM OPN 6 2	Option #/status
(options and status'	
are listed for each	
option through option	
#45)	

DEFAULT LEVEL 1	Default level
PLU LEVEL SYSTEM 0	level numbering system
DWR LIMIT AMT \$0.00	Cash drawer limit amount

TARE WEIGHT 1 0.000	tare #/weight
TARE WEIGHT 2 0.000	tare #/weight
TARE WEIGHT 3 0.000	tare #/weight
TARE WEIGHT 4 0.000	tare #/weight
TARE WEIGHT 5 0.000	tare #/weight

PC ON TIME 99.99	Preprogrammed polling time

CLERK 01 No.00001	Clerk/Consecutive #
TIME 12:00 00	Time/Register #

Key Location Program Scan

DATE 08/15/2003 SUN	Date/Day

FKEY LOCATION SCAN	TYPE OF READOUT

1:F/S SHIFT	Location #/key
2:LEVEL1	(listed for each
3:LEVEL2	location)
4:LEVEL3	
5:ERRCORR	
6:% 1	
7:% 2	
8:TAX1	
9:TAX2	
10:NOSALE	
11:PLU	
12:P/O	
13:R/A	
14:VOID	
15:RETURN	
16:CANCEL	
17:XTIME	
18:CLERK	
19:F/S SUBT	
20:F/S TEND	
21:EAT-IN	
22:TAKE-OUT	
23:CHARGE2	
24:CHARGE1	
25:CHECK	
26:SUBTOTAL	
27:CASH	
CLERK 01 No.00001	Clerk/Consecutive #
TIME 12:00 00	Time/Register #

Macro Program Scan

DATE 08/15/2003 SUN	Date/Day

MACRO KEY SCAN	TYPE OF READOUT

MACRO 1 :	Macro #1
1	(keys executed by this
2	macro are listed here)
3	
4	
5	
NOSALE	
MACRO 2 :	Macro #2
MACRO 3 :	Macro #3
MACRO 4 :	Macro #4
MACRO 5 :	Macro #5
CLERK 01 No.00001	Clerk/Consecutive #
TIME 12:00 00	Time/Register #

Glossary of Terms

Activity Count

The activity counter keeps track of the number of times an entry is made on a PLU, or function key.

Audaction

Refers to the total of all negative sale transactions.

Clerks/Cashiers

Although often used interchangeably, the terms 'clerk' and 'cashier' have separate meanings.

- Sales *clerks* are individuals who are responsible for selling the merchandise to the customer. A clerk may or may not actually operate the cash register (a cashier might ring sales for many different clerks). Typically, management wants to know merchandise sales levels for each clerk, in order to monitor productivity and/or pay commissions.
- *Cashiers* actually operate the cash register, and are usually held responsible for cash, checks, and other media in the cash drawer. When new cashier begins operations, the drawer is usually counted so that responsibility can be shifted to another cashier. Or, when two cashiers are operating the same cash register at the same time, an optional second cash drawer can be installed so that each cashier can be held individually accountable.

In many establishments, clerks and cashiers perform similar functions. Cashiers can be clerks; clerks are often cashiers.

Compulsory

When an operation is programmed compulsory, a function (i.e. Non-add number entry) must be performed in order to complete the operation.

Consecutive Number

A count appears at the bottom of each receipt and after each transaction on the journal tape. This count increases by one with each transaction, report, or scan.

Default Program

The original program installed in the *ER-5115*. The register has a default program that makes it operational after a RAM clear. Nearly all option, rate, and status programs are set to zero as the default condition.

Default Level

The level set, via programming, as the main, or surface level. When levels are programmed as Pop-up levels, the keyboard returns to this level automatically.

Discount (Item)

An item discount (coupon or %) subtracts an amount or percentage from the price of an item. This subtraction nets the PLU total.

Discount (Sale)

A sale discount (coupon or %) subtracts an amount or percentage from the entire sale.

Error Condition

An error condition signals that illegal operation has occurred. It is identified by an audible tone and an error descriptor appearing on the display.

Error Correct

An error correct operation voids the last item entered, it must be used within a sale.

Gallonage

Gallonage is a status that may be assigned to a PLU. Gallonage PLUs accept a price, but print both the price and the quantity of gallons sold. The quantity of gallons is computed from the price per gallon, which is set as the preset price in Program 200.

Hash

Hash status for a PLU allows the amount of the PLU entry to add to the sale, as well as the individual PLU total on the PLU report. However, the amount is not added to the Net sales, Gross sales, or Grand total. Hash status is used to account for sales of items such as lottery tickets, or bottle deposits, that do not represent reportable income.

HALO

The high amount lock-out (HALO) limits the amount allowed to be entered in a PLU, or function key.

Journal

The journal tape is a separate tape that records all of the transactions on the register. This is the management's copy of all register activity.

No Sale

No sale is an operation to simply open the cash drawer.

Override

Override is an operation used to bypass a programmed price or HALO.

Post Tendering

The Post Tendering feature allows the operator to use the register to compute change on cash transactions after the sale has been finalized.

To calculate change due after finalizing the sale, enter the cash amount presented by the customer and then press **CASH**. The amount of change due the customer is then displayed, and the cash drawer will open.

This is a calculation function only, and no totals or counters are updated by the use of this feature.

PLUs

Price look-ups (PLUs) are accessed by indexing a code number and pressing the PLU key, or by pressing a PLU key located on the keyboard. PLUs may be programmed with a preset or open price. PLUs record their own activity count and dollar total on the PLU report.

Receipt

A receipt is a printed tape given to a customer as a record of the sale transaction.

Register Number

The register number is a programmable number that prints on the receipt and journal tapes. It identifies the electronic cash register the sale or report was performed on.

Surcharge (Item)

An item percent surcharge adds a percentage to the price of an item. This addition nets the PLU total.

Stay-Down

When a function is programmed as a Stay-down function, it is valid until changed. For example, a Stay-down clerk remains signed on until either signed off, or another clerk is signed on. A Stay-down level is in effect until another level key is pressed.

Surcharge (Sale)

A sale percent surcharge adds a percentage to the entire sale.

Tax Except

Tax except is used to exclude the tax from an entire sale.

Tax Shift

Tax shift keys are used to reverse the tax status of a PLU entry.

Tender

The method of register operation in which payment is made and the transaction is finalized.

Void

A void operation will erase a previous item entry. It must be used inside of a sale only.

Index

#

#/No Sale - Function Key Programs · 119

%

% Key - Function Key Programs · 143

A

abbreviated Financial report
system option #3 · 109
Add Check function · 41
amount
status for % Key · 143

B

Break Points · 95
Buffered receipt
system option #26 · 111

C

Cancel - Function Key Programs · 120
Cash - Function Key Programs · 121
Cash declaration
system option #1 · 109
cashier report (media totals on clerk)
system option #7 · 109
Cash-In-Drawer Limit Programming · 155
Charge - Function Key Programs · 122
charge tip (function of % key) · 23
Check - Function Key Programs · 123
Check Cash - Function Key Programs · 124
Check Endorsement Message Programming · 150
Clerk
Descriptor Programming · 147
Drawer Assignment · 146
Program Scan · 163

Secret Code Programming · 146
clerk/table # control
system option #39 · 113
code entry clerks
system option #15 · 110
Compulsory condiment entry
status for PLU · 100
Compulsory drawer
system option #17 · 110
Compulsory non-add number
status for PLU · 100
Compulsory scale entry
status for PLU · 100
Compulsory tare weight
system option #20 · 111
compulsory tendering
Cash key · 121
Charge key · 122
compulsory validation
% Key · 143
Cancel key · 120
Cash key · 121
Charge key · 122
Check Cash key · 124
Check key · 123
Drive Thru key · 126
Eat-In key · 127
Error Correct key · 128
No Sale function · 119
P/O key · 133
Promo key · 132
R/A key · 134, 135
Take-Out key · 138
Tray Subtotal · 140
Void · 141
Waste key · 142
Compulsory validation
status for PLU · 100
condiment
status for PLU · 100
consecutive number printing
system option #11 · 110
Currency character
system option #16 · 110
Currency Conversion - Function Key Programs · 125

D

Date format
 system option #13 · 110
date printing
 system option #12 · 110
Date Programming · 157
Day of Week Programming · 157
Decimal print and display
 system option #14 · 110
Default Level Programming · 156
Default Program · 90
Descriptor Code Chart - ER-5140 · 105, 117, 148, 151
Descriptor Programming
 PLU · 104
direct entry clerks
 system option #15 · 110
direct multiplication
 system option #37 · 112
Drive Thru - Function Key Programs · 126
Drive thru compulsory
 system option #37 · 112

E

Eat-In - Function Key Programs · 127
Eat-in compulsory
 system option #37 · 112
Error Correct - Function Key Programs · 128

F

food stamp eligible
 status for PLU · 100
Food Stamp Tender - Function Key Programs · 129
foreign currency · 58, 125
Function Key Assignment · 91
Function Key Codes · 92
Function Key Descriptor · 117
Function Key HALO · 118
Function Key Options · 116
Function Key Program Scan · 162
Function Key Programming · 114

G

gallonage
 status for PLU · 100
Goods & Services Tax (GST) · 93
Grand total on financial report
 system option #2 · 109
Gross total print on the Financial report
 system option #8 · 109
Group Assignment
 PLU · 101
Group Descriptor Program Scan · 164

Group Status and Descriptor Programming · 152
Guest # - Function Key Programs · 130

H

hash
 status for PLU · 100
HASH PLU control
 system option #38 · 112

I

inactive
 status for % Key · 143
 status for Cancel key · 120
 status for Check Cash key · 124
 status for Error Corr key · 128
 status for No Sale function · 119
 status for P/O key · 133
 status for PLU · 100
 status for Promo key · 132
 status for R/A key · 134, 135
 status for Scale key · 136
 status for Void key · 141
 status for Waste key · 142
Inventory Amount Programming · 103
Inventory counter
 status for PLU · 100
Inventory counter programming
 system option #40 · 113

J

journal skip
 system option #23 · 111

K

Key Location Program Scan · 167

L

level keys, disabling
 system option #35 · 112
Link Programming
 PLU · 106

M

Machine Number Programming · 155
Macro Key Sequence Programming · 149
Macro Program Scan · 168

manager control
 % key · 143
 Cancel key · 120
 Cash tendering · 121
 charge tendering · 122
 Check Cash key · 124
 Check tendering · 123
 Error Correct · 128
 negative sales · 111
 No Sale function · 119
 P/O key · 133
 Promo key · 132
 R/A key · 134, 135
 Scale key · 136
 Void · 141
 Waste key · 142
media totals on clerk report
 system option #7 · 109
multiple buffered receipts
 system option #26 · 111
multiple validations
 system option #25 · 111

N

negative
 status for % Key · 143
 status for PLU · 100
negative sale control
 system option #23 · 111
number of items on receipt
 system option #27 · 111

O

open
 status for PLU · 100
Open drawer alarm
 system option #18 · 110
open drawer warning
 system option #19 · 110
optional printer setup
 system options #42-45 · 113

P

Paid Out - Function Key Programs · 133
Paper sensor
 system option #17 · 110
PC Schedule Operation Programming · 158
percentage
 status for % Key · 143
percentage of sales on the PLU report
 system option #6 · 109
PLU Descriptor Programming · 104
PLU Group Assignment · 101
PLU Link Programming · 106

PLU Number Assignment for Keyboard PLUs · 98
PLU preset/HALO override
 system option #24 · 111
PLU Price/HALO Programming · 102
PLU Program Scan · 160
PLU Stock Amount Programming · 103
pop-up · 112
pop-up clerks
 system option #15 · 110
pop-up levels
 system option #34 · 112
post tender
 system option #33 · 112
preset
 status for % Key · 143
 status for PLU · 100
preset override
 % Key · 143
preset tender keys · 23
Previous Balance - Function Key Programs · 131
Price does not print
 status for PLU · 100
Price/HALO Programming · 102
 PLU · 102
print on detail
 status for PLU · 100
print on guest check
 status for PLU · 100
print on receipt
 status for PLU · 100
Print postamble
 system option #31 · 112
Program Scans · 159
Promo - Function Key Programs · 132

R

Receipt Message Program Scan · 165
Receipt Message Programming · 150
Received on Account - Function Key Programs · 134
RED on kitchen printer
 status for PLU · 100
register number printing
 system option #12 · 110
Register Number Programming · 155
reset consecutive number
 system option #4 · 109
reset grand total
 system option #4 · 109
rounding rules
 system options #28 & #29 · 111

S

Scale - Function Key Programs · 136
Scale Tare Weight Programming · 154
single item
 status for PLU · 100

Stamp and Logo printing
 system option #30 · 112
stay down levels
 system option #34 · 112
staydown clerks
 system option #15 · 110
Stock Amount Programming · 103
Stock counter programming
 system option #40 · 113
Straight Percentage Tax Rate · 93, 94
Subtotal printing
 system option #27 · 111
System Option Program Scan · 166
System Option Programming · 108
System Option Table · 109

T

Table # - Function Key Programs · 137
Take Out - Function Key Programs · 138
Take-out compulsory
 system option #37 · 112
Tare Weight Programming · 154
Tax amount printing
 system option #21 · 111
Tax Exempt - Function Key Programs · 139
Tax Program Scan · 161
Tax Shift Operations · 43
Tax Table Programming · 95
taxable
 status for % Key · 143
 status for PLU · 100
taxable total printing
 system option #21 · 111
time printing
 system option #12 · 110
Time Programming · 157
Tip operation · 143
Training mode
 system option #32 · 112
Training Mode
 Entering · 49
 Exiting · 49
Tray Subtotal - Function Key Programs · 140

V

validate tender or total
 system option #25 · 111
Validation · *See* compulsory validation
Validation sensor
 system option #17 · 110
Value added tax (VAT) · 93
VAT printing
 system option #22 · 111
Void - Function Key Programs · 141
Void/Return totals on the Financial report
 system option #8 · 109

W

Waste - Function Key Programs · 142
Weight symbol · 136

X

X lock position control · *See* manager control

Z

Z counter print on reports
 system option #11 · 110
Z counters
 system options #9 & #10 · 109
zero skip on clerk report
 system option #7 · 109
zero skip on financial
 system option #3 · 109
zero skip on group report
 system option #3 · 109
zero skip on PLU report
 system option #6 · 109