Samsung ER-5200M Series

SAM52M **User's Manual**



All specifications are subject to change without notice.

Version 2.3
©2008, CRS, Inc.

CRS, Inc.

Limited Warranty and Disclaimers of Warranty

This manual has been developed by CRS, Inc. It is intended for the use of its customers and service personnel and should be read in its entirety before attempting to install, use or program the product(s).

Nothing contained in this manual shall be deemed to be, and this manual does not constitute, a warranty of, or representation with respect to, the product or any of the products to which this manual applies. This manual is subject to change without notice and CRS, Inc. has no obligation to provide any updates or corrections to this manual. Further, CRS, Inc. also reserves the right, without prior notice, to make changes in equipment design or components as it deems appropriate. No representation is made that this manual is complete or accurate in all respects and CRS, Inc. shall not be liable for any errors or omissions contained in this manual. In no event shall CRS, Inc. be liable for any incidental or consequential damages relating to or arising out of the use of this manual. This document contains proprietary information that is protected by copyright. All rights are reserved. No part of this document may be photocopied or reproduced without prior written consent of CRS, Inc.

NOTICE

IF ANY WARRANTY IS EXTENDED TO YOU WITH REGARD TO THE PRODUCT(S) TO WHICH THIS MANUAL APPLIES, IT IS A WARRANTY FROM THE ENTITY OR INDIVIDUAL FROM WHOM YOU DIRECTLY PURCHASED THE PRODUCT(S).

SUBJECT TO THE FOREGOING, UNLESS YOU ARE A DIRECT END USER CUSTOMER OF CRS, INC., CRS, INC. DOES NOT EXTEND TO YOU ANY EXPRESS WARRANTY OR ANY IMPLIED WARRANTY AND EXPRESSLY DISCLAIMS ANY IMPLIED WARRANTY OF MERCHANTABILITY, FITNESS FOR USE, OR FITNESS FOR ANY PARTICULAR PURPOSE, OR ANY WARRANTY OF NON-INFRINGEMENT OF INTELLECTUAL PROPERTY RIGHTS IN CONNECTION WITH THE PRODUCT(S) OR ANY SOFTWARE, DRIVERS, OR PROGRAMMING PRODUCT, WHETHER EMBEDDED IN PRODUCT(S) OR PROVIDED AS A SEPARATE PROGRAM, OR USED IN CONJUNCTION WITH THIS/THESE PRODUCT(S). CRS, INC. SPECIFICALLY DOES NOT WARRANT THAT THE OPERATION OF ANY DRIVERS, SOFTWARE, OR PROGRAMMING PRODUCTS LICENSED HEREUNDER, WHETHER EMBEDDED IN PRODUCTS OR PROVIDED AS SEPARATE PROGRAMS, SHALL BE UNINTERRUPTED OR ERROR FREE OR THAT FUNCTIONS CONTAINED IN SUCH DRIVERS, SOFTWARE OR PROGRAMMING PRODUCTS SHALL OPERATE IN COMBINATION(S) WHICH MAY BE SELECTED FOR USE BY YOU OR OTHERWISE MEET YOUR REQUIREMENTS.

CRS, Inc. is not responsible for any damages or loss, either direct, indirect, special, incidental or consequential, which you may experience as a result of your purchase or use of the product(s). Your sole remedy in the event that you encounter any difficulties with the product(s) is against the entity or individual from whom you purchased the product(s).

Revision 2.0 - April 1, 2005

Contents

- Introduction** **1**
 - Overview 1
 - Features 1
 - Requirements 1
 - Installing** 2
 - Cash Register Settings 3
 - RS-232 Option Chart 3
 - Preparing the *ER-5200M* for Communicatons 4
 - Starting 5
 - Navigating 6
 - Mouse and Keyboard 6
 - Viewing Menus and Selecting Menu Items 6
 - Drop-Down List Boxes 8
 - Check Boxes 8
 - Option Buttons 8
 - Scrolling 8
 - Interface Specifications 9

- Menu Functions** **10**
 - Stores 10
 - Creating a New Store 10
 - Selecting the Default Store 12
 - Editing Store Information 13
 - Deleting A Store 13
 - Edit ECR Data 15
 - PLU File 16
 - Group 21
 - Tax 22
 - System Options 23
 - Print Options 24
 - Function Keys 25
 - Clerks 26
 - Logo Description 27
 - Financial Messages 28
 - Clerk Messages 29
 - Misc 30
 - Mix and Match 35
 - Stock 36
 - Communications 37
 - Polling 37
 - Send Programs to ECR (Download) 39
 - Receive Programs from ECR (Upload) 40
 - Polling Setup File 41

Download Bitmap Image.....	42
Print	45
Daily Poll File.....	46
Log Files.....	47
PLU File	50
PLU Range	51
Consolidated Store Report.....	52
Remove.....	53
Old Poll Files.....	53
Log Files (Upload, Download, Poll)	53
Utilities	54
Copy a Store	54
Copy PLU File.....	55
After Polling	56
Set Auto Poll	57
Length of Polling Time	58
Backup Poll Data Files	58
Design 5200M Keyboard	59
Design Generic Keyboard	60
Fix PLU File.....	61
Calculate Number of PLUs.....	61
View Memory Allocation.....	62
Quit.....	63

Appendices 64

Structure Of Stores	64
File Definitions	65
SAM52M PLU File Structure.....	65
Structure Of Polling Files	67
Sample Reports	69
Financial Report	69
Time Report.....	70
PLU Report.....	71
Clerk Report (Data for One Clerk Only)	71
Group Report.....	72
Troubleshooting Common Problems	73
Hardware	73
Software.....	73
Samsung ER 5200M Series	73
SAM52M Software.....	73
Cabling Diagrams	74

Manual Revision Record 75

Introduction

Overview

Features

SAM52M controls the connection between a Samsung ER 5200M Series (ER-5215M, 5240M, or ER-5200M) electronic cash register and an IBM compatible PC running in a Windows 95/98/2000 environment. Using *SAM52M* at your PC, you can:

- Connect directly, via telephone modem or by Internet.
- Upload program files from the register to the PC.
- Edit cash register programs.
- Download program files to the register from the PC.
- Download bitmap images for custom pre/post logos.
- Poll reports from the register, save, display or print them at the PC.
- Poll all stores, or individual stores.
- Poll unattended at a predetermined time.
- Download preamble/postamble bitmap files.
- *SAM52M* converts polled reports to ASCII files, ready to be used by other PC applications.

Requirements

To use this utility, you must have:

- Pentium 100 or faster CPU.
- 32 MB RAM.
- 150 MB minimum hard disk space available.
- Dedicated serial port (RS-232C).
- CD ROM drive.
- VGA or SVGA display.
- Windows 95 or above operating system.
- US Robotics Sportster™ Modems are recommended for remote connections (for both PC and ECR sites.)

Installing

Note: SAM52M Software can also be downloaded from www.crs-usa.com.

Note: The Sam52M software can be used as Save/Load software with out installing the software key. To edit any programming as described in this manual you will need to install the USB or LPT key on the appropriate port on your PC.

1. Load the *SAM52M* program CD into your CD drive.
2. From the Windows Desktop, choose the *My Computer* icon.
3. Select your CD ROM drive (usually drive "D".)
4. Choose Setup, the Welcome dialog displays.
5. Click **Next**, the Ready to Install dialog displays.
6. Click **Next**, the Install Directory dialog displays.
7. Click **Next**, the Select Shortcut Folder dialog displays.
8. Click **Next**. When all files are copied, the Finished dialog displays.
9. Click **Finish**.
10. Click **OK** to restart your PC.
11. Remove the CD from the drive, your installation is complete.

Cash Register Settings

To communicate with your *Samsung ER-5200M Series* ECR, you must set the RS232C port for the PC function.

Setting the RS232C Port Options

You must select 'PC' as the device that is attached to the RS-232C communications port.

1. Turn the control lock to the **S** position.
2. Enter **8 0** (enter **8 1** to program the second port) and press the **SBTL** key.
3. Enter **5** and press the **X/TIME** key. (Refer to the chart RS-232C option chart that follows.)
4. Enter **1** (the value for PC) and press the **CASH** key.
5. Press **CASH** to exit the program.

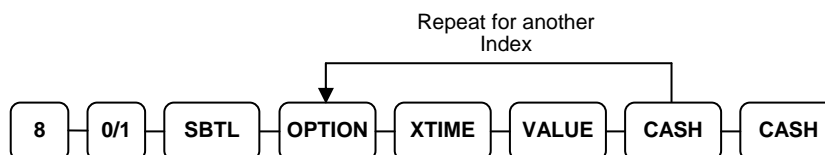

RS-232 Option Chart

Address	Option	Value	Selection
1	Baud Rate	0	9600 BPS
		1	1200 BPS
		2	2400 BPS
		3	4800 BPS
		4	19200 BPS
2	Parity	0	NONE
		1	ODD
		2	EVEN
3	Data Bits	0	8 BITS
		1	7 BITS
4	Stop Bits	0	1 BIT
		1	2 BIT
5	Device Function	0	NONE
		1	PC
		2	SCALE
		4	Receipt Printer
		5	Not used
		7	COIN
		9	Pole Display
		10	PDC (Requires V6.1 or later)
6	Initial Feeding Line KP	0 - 20	
7	End Feeding Line KP	0 - 20	
8	Initial Feeding Line Slip	0 - 20	
9	Print Line On Guest Check	0 - 50	

10	Scale Type	0	NCI
		1	CAS
11	Printer Type	0	NONE
		1	SAMSUNG SRP-100
		2	SRP-250
		3	SRP-300
		4	SRP-350
		5	CITIZEN 3550
		6	CITIZEN 810
		7	CITIZEN 230
		8	EPSON TM T88-2
		9	EPSON U200
		10	EPSON U295
		11	EPSON U300
		12	EPSON U325
		13	EPSON U375
		14	STAR SP-200
		15	STAR SP-298
		16	STAR SP-300
17	STAR TSP-200		
12	Display Type	0	EPSON
		1	ICD

Preparing the *ER-5200M* for Communicatons

The register must be ready for communications:

- Connect the register directly to the PC with the appropriate cable. See “Cabling Diagrams” on page 74.
- The register power must be on.
- A clerk must be signed on.
- The register cannot be inside of a transaction.
- The key lock can be in any position.

It is not necessary to manually place the register in PC Communications mode. SAM52M will automatically place the register in PC Communications mode when communications are initiated.

Starting

1. Click the **Start** button, click **Programs**, click **SAM52M**, and then click **SAM52M.exe**.
2. The *SAM52M* main screen displays.

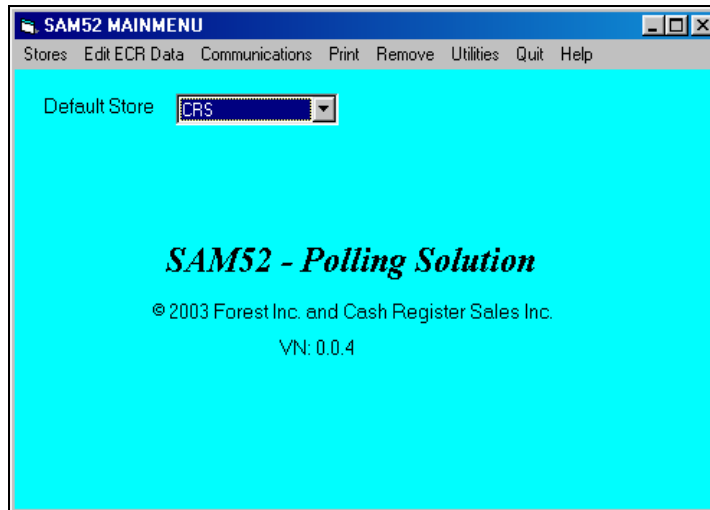

YOU MUST DO THIS FIRST!

Before you can attempt communications or editing, you must create at least one store. Refer to "Creating a New Store" on page 10.

After creating a store, you must Receive (Upload) information from the ECR. Refer to "Receive Programs from ECR (Upload)" on page 40.

Navigating

Mouse and Keyboard

You can choose a menu, menu item, or a command by clicking on it with your mouse.

Viewing Menus and Selecting Menu Items

1. Point at a menu item with your mouse.
2. Point at your choice on the menu and click the left mouse button.

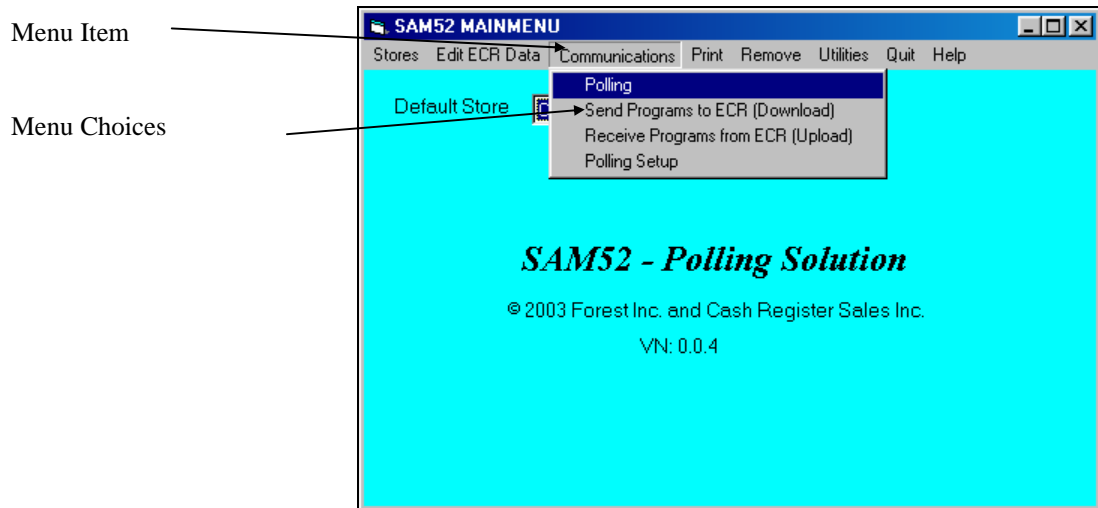

Cascading Menus

1. The arrow indicates additional choices cascade from the first menu.
2. Move the mouse pointer in the direction of the arrow to display additional choices.

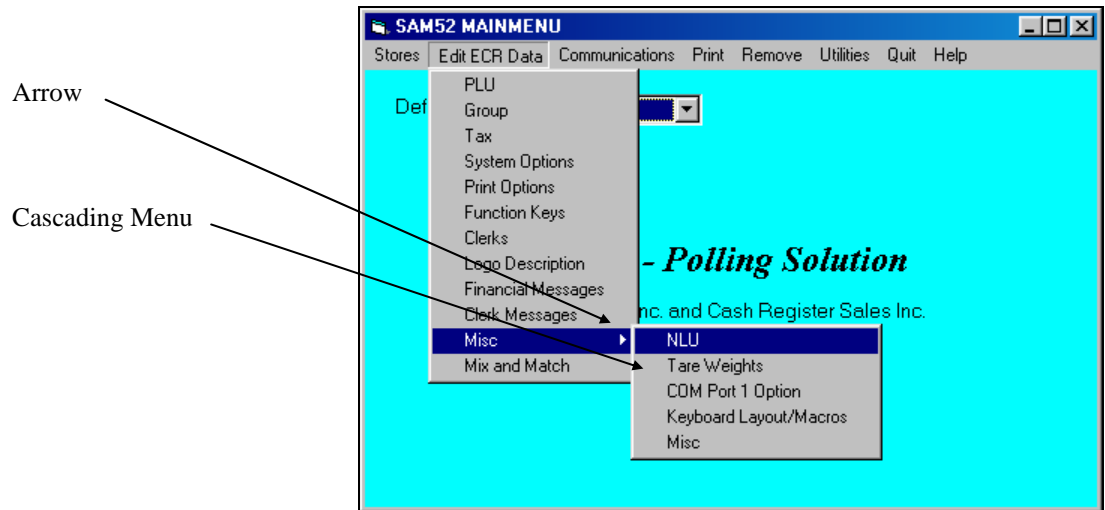

Drop-Down List Boxes

- ◆ Click on the arrow in the box to open the drop-down list box and display a list of choices. Click on an item to select it. (If all the choices are not in view, scroll bars are provided.)



Check Boxes

- ◆ Click on a check box to make a selection. Click the check box again to deselect the item

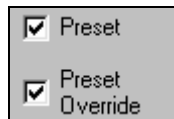

Option Buttons

- ◆ Click on one of the option buttons (also called radio buttons) to make a selection. Your previous selection will pop-up when a new selection is made.

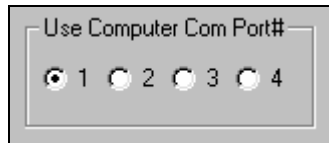

Scrolling

- ◆ Move the scroll box to select the item you wish to work with. Drag the scroll box or click the scroll arrows to find your selection.

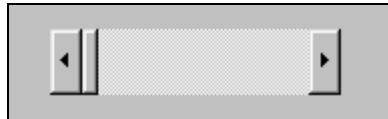

Interface Specifications

Communications Specifications

Asynchronous Operation

Communication Mode Half Duplex

Baud Rate Select: 2400, 4800, or 9600 BPS

Signal Level RS-232C

Character Bits 8

Parity Bits None

Stop Bits 1

Error Detection Data sum check

Menu Functions

Stores

A store must be created before any communications or editing can take place.

Creating a New Store

1. Choose **Create New** from the *Store* menu to create a store. You can create an unlimited number of stores. The *Create New Store* dialog displays.

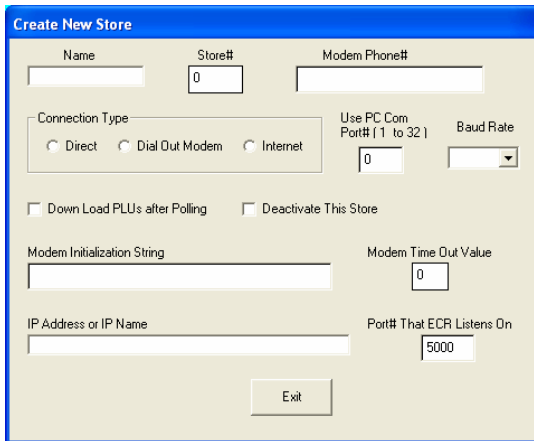

The screenshot shows a dialog box titled "Create New Store" with a blue header bar. The dialog contains several input fields and options:

- Name:** An empty text input field.
- Store#:** A text input field containing the number "0".
- Modem Phone#:** An empty text input field.
- Connection Type:** A group box containing three radio buttons: "Direct" (selected), "Dial Out Modem", and "Internet".
- Use PC Com Port# (1 to 32):** A text input field containing "0".
- Baud Rate:** A dropdown menu.
- Down Load PLUs after Polling:** An unchecked checkbox.
- Deactivate This Store:** An unchecked checkbox.
- Modem Initialization String:** An empty text input field.
- Modem Time Out Value:** A text input field containing "0".
- IP Address or IP Name:** An empty text input field.
- Port# That ECR Listens On:** A text input field containing "5000".
- Exit:** A button at the bottom center.

2. Complete the *Create New Store* dialog according to the Store Information table below:

Store Information

Field Name	Required /Optional	Description/Instructions
<i>Name</i>	R	Enter an eight-character store name.
<i>Store#</i>	O	Enter a four digit number store number.
<i>Modem Phone#</i>	O	Enter the Phone number preceded by the letter T or P if you intend to communicate with the register by modem. The T is for TONE and the P is for PULSE. If you communicate direct, leave this field blank.
<i>Connection Type</i>	R	Choose <i>Direct</i> , <i>Dial Out Modem</i> , or <i>Internet</i>
<i>Use PC COM Port# (1-32)</i>	R	Enter the PC serial port (COM1- COM32) that you are using for communications.
<i>Baud Rate</i>	R	Select 9600, 4800, 2400, 1200, or 19,200. Be sure that the rate set on the register (Port Settings) matches the store information rate set here.
<i>Down Load PLUs after Polling</i>	O	Enter Y if you wish to download PLUs in a polling session. When the session is finished polling, the program will download the PLU file.
<i>Deactivate This Store</i>	O	Select the <i>Deactivate This Store</i> check box if you wish the store to be inactive.
<i>Modem Time Out Value</i>	R	Unless otherwise indicated, the default value of 99 will be entered automatically when the store is created
<i>Modem Initial String</i>	O	This field is to allow you to enter any initialization required for your modem for polling or communications. Do not add the command prefix "AT" in this string. If you are using the U.S. Robotics Sportster modem, it would be good to initialize with the string S7=60. This value makes the modem wait for up to 60 seconds to detect a carrier. If no carrier is detected within 60 seconds after you dial, the modem will answer back with No Carrier Detect. Do not put into this string any E, Q or V values. The software automatically handles these values.
<i>IP Address or IP Name</i>	O	If connection is Internet, enter IP address or IP name.
<i>Port# That ECR Listens On</i>	O	If connection is Internet, enter the port the router listens on. (Default is 5000)

3. Click **Exit** to save store information.

Selecting the Default Store

- ◆ Click the *Default Store* drop-down list box to select the working store. When you have created at least one store, the list box will display all stores created. The working store will display in the *Default Store* field. All editing and programming will pertain to the selected working store.

Default Store Drop-down list box



Editing Store Information

1. Choose **Edit** from the *Stores* menu to edit an existing store.

Edit Store Information

Name: GNG 5-5 Store#: 1 Modem Phone#:

Connection Type: Direct Dial Out Modem Internet

Use PC Com Port# (1 to 32): 4 Baud Rate: 19200

Down Load PLLs after Polling Deactivate This Store

Modem Initialization String:

Modem Time Out Value: 99

IP Address or IP Name:

Port# That ECR Listens On: 0

Exit

2. Refer to the "Store Information" table on page 11 to complete the *Edit Store Information* dialog.
3. Click **Exit** to save store information.

Deleting A Store

1. Choose **Delete** from the *Stores* menu to delete the working store from you hard drive. A warning dialog displays.

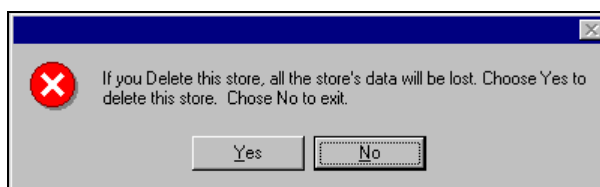

2. Click **Yes** to delete the store.

Caution: This function will erase everything that pertains to this store. Use extreme caution with this function. Information that is deleted cannot be recovered.

Edit ECR Data

From the *Edit ECR Data* menu, select a specific item to edit that part of an existing Samsung *ER-5200M* series ECR program. Remember that the options in this program allow you to edit the same program options that you set on a standalone *ER-5200M* through the register's keyboard. Detailed questions about the meaning of the register options are best answered by referring to the *Samsung ER-5215M Operators and Program Manual* or the *Samsung ER-5200/5240M Operators and Program Manual*.

Note: If you did not Upload programs from the ECR, you will get a message "The file does not exist" if you attempt to select any of these options.

Note: If you wish to create a program for a new store, you can use the "Copy a Store" function (see page 54) and then edit the copied program to suit your needs.

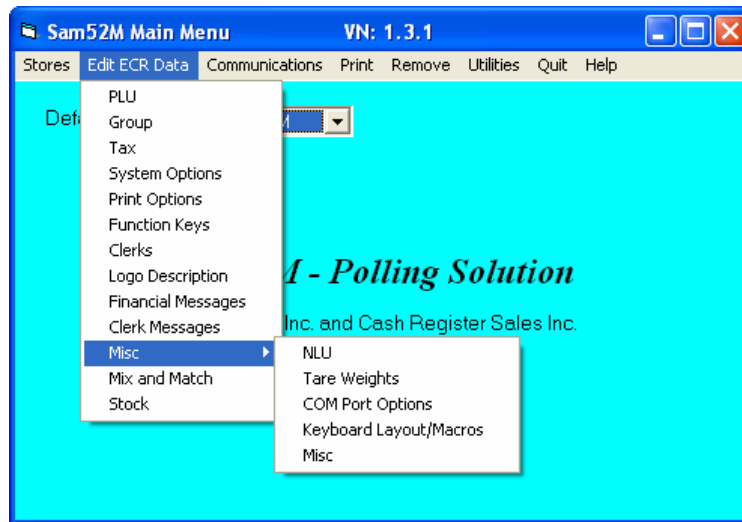

PLU File

The PLU file is maintained here. Follow the instructions on the screen, or refer to the *Samsung ER-5215M Operators and Program Manual* or the *Samsung ER-5200M/5240M Operators and Program Manual* for a complete description of your program options.

- ◆ Choose **PLU File** from the *Edit ECR Data* menu. The appropriate *PLU Programming* dialog box displays:

PLU Programming For Store : JAVATIME

PLU Lookups
 PLU# 00000000000053 Descriptor POPCORN CHICKEN

Groups
 1 2 3
 2 6 0

TAX
 1 3
 2 4

PLU#	Descriptor	Price	Auto Tare	Linked PLU	Mix and Match
53	POPCORN CHICKEN	\$4.95	0	0	0

Preset Single Item Scalable Do Not Reset Counter After Z Report
 Preset Override Compulsory Non-Add# Auto Scale Preset Override In MGR Control
 Food Stamp Gallonage Condiment
 Negative Inventory Item Compulsory Condiment
 Hash Disable Disable Promo

Print PLU
 On Receipt Price On Receipt
 On Display Price On Guest Check
 On Check
 On Journal

Total Active PLUs = 151

Exit Add PLU Edit PLU Delete PLU

Editing a PLU

1. Select the PLU you wish to edit:

- Type a PLU number in the PLU # field and press **ENTER**, or open the PLU # drop down list box and click on the PLU you wish to edit. If necessary, use the scroll box to view the list of PLUs in the file.

PLU Lookups

PLU#

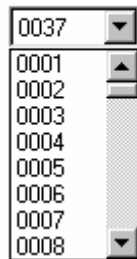

- Type a PLU descriptor in the Descriptor field and press **ENTER**, or open the Descriptor drop down list box and click on the PLU you wish to edit. If necessary, use the scroll box to view the list of PLUs in the file. With the list box open, you can type the beginning letter or letters of a PLU descriptor and PLUs beginning with your entry will display in the box.

Descriptor

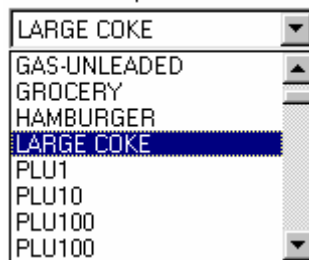

- Click the **Edit PLU** button to open the selection fields for editing.

PLU Programming For Store : JAVATIME

PLU Lookups
 PLU# 00000000000053 Descriptor POPCORN CHICKEN

Groups
 1 2 3
 2 6 0

TAX
 1 3
 2 4

PLU#	Descriptor	Price	Auto Tare	Linked PLU	Mix and Match
53	POPCORN CHICKEN	\$4.95	0	0	0

Preset Single Item Scalable Do Not Reset Counter After Z Report
 Preset Override Compulsory Non-Add# Auto Scale Preset Override In MGR Control
 Food Stamp Gallonage Condiment
 Negative Inventory Item Compulsory Condiment
 Hash Disable Disable Promo

Print PLU
 On Receipt Price On Receipt
 On Display Price On Guest Check
 On Check
 On Journal

Total Active PLUs = 151

Save Add PLU Edit PLU Delete PLU

- Edit fields as necessary by moving your mouse pointer to the field you wish to edit:
 - Edit fields with numeric information by clicking on the field, and then entering new data. If you are entering price data, you must use the decimal key to enter cents.
 - Edit fields with check boxes (such as the PRESET field) by clicking on the field to add or remove a check.
- Click **Save** to save changes, or click **No Save** to exit without saving changes

Note: For double-wide characters hold down the **ALT** key, type **0253**, then type the character you wish to program. You will need to don this for each double-wide character.

Adding a PLU

1. Click the **Add** button. A new PLU screen opens for entries:

PLU Programming For Store : SHOWROOM

PLU Lookups

PLU# Descriptor

Groups

1 2 3

0 0 0

TAX

1 3

2 4

PLU# Descriptor Price Auto Tare Linked PLU Mix and Match

0 \$0.00 0 0 0

Preset Single Item Scalable Do Not Reset Counter After Z Report

Preset Override Compulsory Non-Add# Auto Scale Preset Override In MGR Control

Food Stamp Gallonage Condiment

Negative Inventory Item Compulsory Condiment

Hash Disable Disable Promo

Print PLU

On Receipt Price On Receipt

On Display Price On Guest Check

On Check Price On Guest Check

On Journal

Total Active PLUs = 151

Save Add PLU Edit PLU Delete PLU

2. Enter the PLU number you wish to assign in the *PLU #* field, and then complete the remaining fields for the new PLU. .
 - Fill fields requiring numeric information by clicking on the field, then entering data. If you are entering price data, you must use the decimal key.
 - Fill fields with check boxes (such as the PRESET field) by clicking on the field to add or remove a check.
3. Click **Save** to save changes, or click **No Save** to exit without saving changes

Note: For double-wide characters hold down the **ALT** key, type **0253**, then type the character you wish to program. You will need to don this for each double-wide character.

Deleting a PLU

1. Select the PLU you wish to delete by number or descriptor.
2. Click the **Delete PLU** button.
3. A warning dialog displays asking if you are sure you wish to delete the PLU.



4. Click **Yes** to delete the PLU; click **No** to abort the delete process.

Note: PLUs deleted at the PC are not automatically deleted at the ECR. You must run PLU reports at the ECR and then delete PLUs at the ECR.

Group

You can program the descriptor and options for each group. (The number of groups is determined in the register's memory allocation, with a maximum of 99 groups.) Follow the instructions on the screen, or refer to the *Samsung ER-5215M Operators and Program Manual* or the *Samsung ER-5200M/5240M Operators and Program Manual* for a complete description of your program options.

1. Choose **Groups** from the *Edit ECR Data* menu. The *Group Programming* dialog box displays:

Group#	Descriptor	Add To Group Totals	Send To KP	KP Port# is 1	KP Port# is 2	KP Port# is Receipt	Print Red On KP	Gift Card
1	GROUP 1	<input checked="" type="checkbox"/>	<input type="checkbox"/>	<input type="checkbox"/>	<input type="checkbox"/>	<input type="checkbox"/>	<input type="checkbox"/>	Not
2	GROUP 2	<input checked="" type="checkbox"/>	<input type="checkbox"/>	<input type="checkbox"/>	<input type="checkbox"/>	<input type="checkbox"/>	<input type="checkbox"/>	Not
3	GROUP 3	<input checked="" type="checkbox"/>	<input type="checkbox"/>	<input type="checkbox"/>	<input type="checkbox"/>	<input type="checkbox"/>	<input type="checkbox"/>	Not
4	GROUP 4	<input checked="" type="checkbox"/>	<input type="checkbox"/>	<input type="checkbox"/>	<input type="checkbox"/>	<input type="checkbox"/>	<input type="checkbox"/>	Not
5	GROUP 5	<input checked="" type="checkbox"/>	<input type="checkbox"/>	<input type="checkbox"/>	<input type="checkbox"/>	<input type="checkbox"/>	<input type="checkbox"/>	Add
6	GROUP 6	<input checked="" type="checkbox"/>	<input type="checkbox"/>	<input type="checkbox"/>	<input type="checkbox"/>	<input type="checkbox"/>	<input type="checkbox"/>	Not
7	GROUP 7	<input checked="" type="checkbox"/>	<input type="checkbox"/>	<input type="checkbox"/>	<input type="checkbox"/>	<input type="checkbox"/>	<input type="checkbox"/>	Not
8	GROUP 8	<input checked="" type="checkbox"/>	<input type="checkbox"/>	<input type="checkbox"/>	<input type="checkbox"/>	<input type="checkbox"/>	<input type="checkbox"/>	Not
9	GROUP 9	<input checked="" type="checkbox"/>	<input type="checkbox"/>	<input type="checkbox"/>	<input type="checkbox"/>	<input type="checkbox"/>	<input type="checkbox"/>	Not
10	GROUP 10	<input checked="" type="checkbox"/>	<input type="checkbox"/>	<input type="checkbox"/>	<input type="checkbox"/>	<input type="checkbox"/>	<input type="checkbox"/>	Not
11	GROUP 11	<input checked="" type="checkbox"/>	<input type="checkbox"/>	<input type="checkbox"/>	<input type="checkbox"/>	<input type="checkbox"/>	<input type="checkbox"/>	Not
12	GROUP 12	<input checked="" type="checkbox"/>	<input type="checkbox"/>	<input type="checkbox"/>	<input type="checkbox"/>	<input type="checkbox"/>	<input type="checkbox"/>	Not
13	GROUP 13	<input checked="" type="checkbox"/>	<input type="checkbox"/>	<input type="checkbox"/>	<input type="checkbox"/>	<input type="checkbox"/>	<input type="checkbox"/>	Not
14	GROUP 14	<input checked="" type="checkbox"/>	<input type="checkbox"/>	<input type="checkbox"/>	<input type="checkbox"/>	<input type="checkbox"/>	<input type="checkbox"/>	Not
15	GROUP 15	<input checked="" type="checkbox"/>	<input type="checkbox"/>	<input type="checkbox"/>	<input type="checkbox"/>	<input type="checkbox"/>	<input type="checkbox"/>	Not
16	GROUP 16	<input checked="" type="checkbox"/>	<input type="checkbox"/>	<input type="checkbox"/>	<input type="checkbox"/>	<input type="checkbox"/>	<input type="checkbox"/>	Not
17	GROUP 17	<input checked="" type="checkbox"/>	<input type="checkbox"/>	<input type="checkbox"/>	<input type="checkbox"/>	<input type="checkbox"/>	<input type="checkbox"/>	Not
18	GROUP 18	<input checked="" type="checkbox"/>	<input type="checkbox"/>	<input type="checkbox"/>	<input type="checkbox"/>	<input type="checkbox"/>	<input type="checkbox"/>	Not
19	GROUP 19	<input checked="" type="checkbox"/>	<input type="checkbox"/>	<input type="checkbox"/>	<input type="checkbox"/>	<input type="checkbox"/>	<input type="checkbox"/>	Not
20	GROUP 20	<input checked="" type="checkbox"/>	<input type="checkbox"/>	<input type="checkbox"/>	<input type="checkbox"/>	<input type="checkbox"/>	<input type="checkbox"/>	Not

2. The current options for each group are displayed. Use the scroll box at the right to view all of the groups; use the scroll box at the bottom to view all of the options for each group.
 - Edit the descriptor field by double clicking on the field, then type a new descriptor.
 - Edit fields with check boxes by clicking on the field to add or remove a check.
 - Set gift card status, if applicable, for Activate (to activate a new card) or Add (to add a balance to an existing card.)
3. Click **Exit** to save changes and return to the main menu.

Tax

Each of the 4 possible taxes can be set for an add on percentage, tax table or VAT. Follow the instructions on the screen, or refer to the *Samsung ER-5215M Operators and Program Manual* or the *Samsung ER-5200M/5240M Operators and Program Manual* for a complete description of your program options.

1. Choose **Tax** from the *Edit ECR Data* menu. The appropriate *Tax Rates* dialog box displays:

Tax Rates For JAVATIME

Tax# [] Tax Type [Table]

Tax Rate [0.000]

GST
 Tax1
 Tax2
 Tax3

For Tax Table, enter in cell <Tax> <Break Point# 1>, the 1st Tax Amount Charged.

Blue cells cannot be edited

Break Point#	Tax	Hi-Amount	Break Point Difference
0	0.00	0.07	16
1	0.01	0.23	15
2	0.02	0.38	15
3	0.03	0.53	16
4	0.04	0.69	15
5	0.05	0.84	15
6	0.06	0.99	16
7	0.07	1.15	15
8	0.08	1.30	16
9	0.09	1.46	15
10	0.10	1.61	15
11	0.11	1.76	16
12	0.12	1.92	16

Descriptor [TAX1]

of Non-Repeat Breaks [1] # of Repeat Breaks [13]

Exit

2. Enter the tax you wish to program in the Tax # field, or open the Tax # list box and select the tax you wish to program.
3. Select the type of tax (% Add On, Table, VAT) from the drop-down list at the *Tax Type* field.
4. Depending upon the type of tax selected, the appropriate fields will be activated. Enter a percentage for % Add On or VAT taxes. Fill the break point fields for tax tables.
5. Click **Exit** to save changes and return to the main menu.

System Options

Each system option can be edited. Follow the instructions on the screen, or refer to the *Samsung ER-5215M Operators and Program Manual* or the *Samsung ER-5200M/5240M Operators and Program Manual* for a complete description of your program options.

1. Choose **System Options** from the *Edit ECR Data* menu. The appropriate *System Options* dialog box displays:

Option	Current Setting
Beeper Active	<input checked="" type="checkbox"/>
Real Clerk Key	<input type="checkbox"/>
Clerk Entry: Code = Checkmark, Push = No Checkmark	<input type="checkbox"/>
Clerk Is: Pop Up = Checkmark, Staydown = No Checkmark	<input type="checkbox"/>
Drawer needs to be shut to operate	<input checked="" type="checkbox"/>
Activate Drawer Open Alarm	<input type="checkbox"/>
Seconds to allow drawer to be opened	30
Allow Post Tender	<input type="checkbox"/>
Open Drawer on Post Tender	<input checked="" type="checkbox"/>
Allow Multiple Receipts	<input type="checkbox"/>
Cash Declaration required before Reports	<input type="checkbox"/>
Manager control on Tender of Negative Balance	<input type="checkbox"/>
Manager control on Tender of Zero Balance	<input type="checkbox"/>
Reset transaction Number on Z-Report	<input type="checkbox"/>
Reset Grand Total after Z-Report	<input type="checkbox"/>

Exit

2. The current setting for each system option is displayed. Use the scroll box at the right to view all of the system options.
 - Edit fields with drop-down list boxes by opening the list box and selecting from the available options.
 - Edit fields with check boxes by clicking on the field to add or remove a check.
3. Click **Exit** to save changes and return to the main menu.

Print Options

Each print option can be edited. Follow the instructions on the screen, or refer to the *Samsung ER-5215M Operators and Program Manual* or the *Samsung ER-5200M/5240M Operators and Program Manual* for a complete description of your program options.

1. Choose **Print Options** from the *Edit ECR Data* menu. The appropriate *Print Options* dialog box displays:

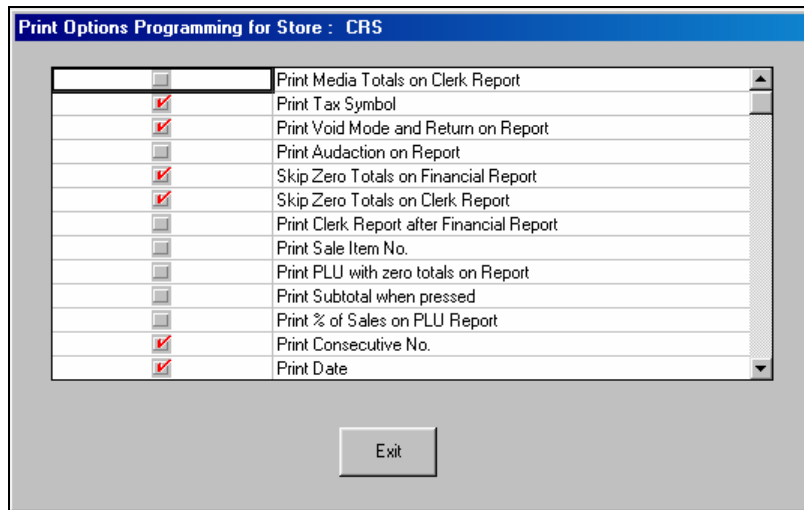

2. The current setting for each print option is displayed. Use the scroll box at the right to view all of the print options.
 - Edit fields with drop-down list boxes by opening the list box and selecting from the available options.
 - Edit fields with check boxes by clicking on the field to add or remove a check.
3. Click **Exit** to save changes and return to the main menu.

Function Keys

You can program the different options for each function key. Follow the instructions on the screen, or refer to the *Samsung ER-5215M Operators and Program Manual* or the *Samsung ER-5200M/5240M Operators and Program Manual* for a complete description of your program options.

1. Choose **Function Keys** from the *Edit ECR Data* menu. The appropriate *Function Keys* dialog box displays:

Descriptor	Price/Rate
NDSALE	0

<input type="checkbox"/>	Disable Key
<input type="checkbox"/>	Under Management Control
<input type="checkbox"/>	Inhibit No Sale After Non-Add #
<input type="checkbox"/>	Enforce # Entry at Start of Sale
<input checked="" type="checkbox"/>	Print On No Sale
<input type="checkbox"/>	Non-Add# Prohibited
<input type="checkbox"/>	Compulsory Non-Add# Must Match Max Digit
<input type="checkbox"/>	Print Non-Add on Guest Check
0	Max Digit (0 - 8)

2. Use the scroll box at the bottom of the screen to select the function key you wish to program.
3. The options for the specific function key are displayed. Make selections or changes as necessary.
 - Edit the descriptor field by clicking on the field, then type a new descriptor.
 - Edit the Price/Rate field by clicking on the field, then entering a new price or rate, whichever is appropriate.
 - Edit fields with drop-down list boxes by opening the list box and selecting from the available options.
 - Edit fields with check boxes by clicking on the field to add or remove a check.
4. If needed, use the scroll box to select additional function keys you wish to program.
5. Click **Exit** to save changes and return to the main menu.

Clerks

Clerk options are set here. Follow the instructions on the screen, or refer to the *Samsung ER-5215M Operators and Program Manual* or the *Samsung ER-5200M/5240M Operators and Program Manual* for a complete description of your program options.

1. Choose **Clerks** from the *Edit ECR Data* menu. The appropriate *Clerk Programming* dialog box displays:

Clerk#	Description	Password	Drawer#
1	SAM	0	1
2	CLERK 2	0	1
3	CLERK 3	0	1
4	CLERK 4	0	1
5	CLERK 5	0	1
6	CLERK 6	0	1
7	CLERK 7	0	1
8	CLERK 8	0	1
9	CLERK 9	0	1
10	CLERK 10	0	1

2. The selections for each clerk are displayed. Make changes as needed.
 - Edit the descriptor field by double clicking on the field, then type a new descriptor.
 - Edit fields with numeric information by double clicking on the field, then enter new data.
3. Click **Exit** to save changes and return to the main menu.

Logo Description

You can program a custom preamble, postamble and check endorsement message. You can also program unique descriptors for financial and clerk report totals. Follow the instructions on the screen, or refer to the *Samsung ER-5215M Operators and Program Manual* or the *Samsung ER-5200M/5240M Operators and Program Manual* for a complete description of your program options.

1. Choose **Logo Descriptor** from the *Edit ECR Data* menu. The appropriate *Logo Programming* dialog box displays:

Logo Programming for Store : CRS	
Preamble Line 1	
Preamble Line 2	Hwy 210 & Hwy 371
Preamble Line 3	
Preamble Line 4	
Preamble Line 5	
Preamble Line 6	
Postamble Line 1	
Postamble Line 2	Gas - Bait - Sporting Goods
Postamble Line 3	Food - Snacks
Postamble Line 4	Car Wash
Postamble Line 5	
Postamble Line 6	
Endorsement Line 1	
Endorsement Line 2	

Exit

2. Use the scroll box at the right of the screen to view all of the logo descriptor fields.
3. Edit the descriptor fields by double clicking on the field, then type a new descriptor.
4. Click **Exit** to save changes and return to the main menu.

Financial Messages

You can also program unique descriptors for financial report totals. Follow the instructions on the screen, or refer to the *Samsung ER-5215M Operators and Program Manual* or the *Samsung ER-5200M/5240M Operators and Program Manual* for a complete description of your program options.

1. Choose **Financial Messages** from the *Edit ECR Data* menu. The appropriate *Financial Messages* dialog box displays:

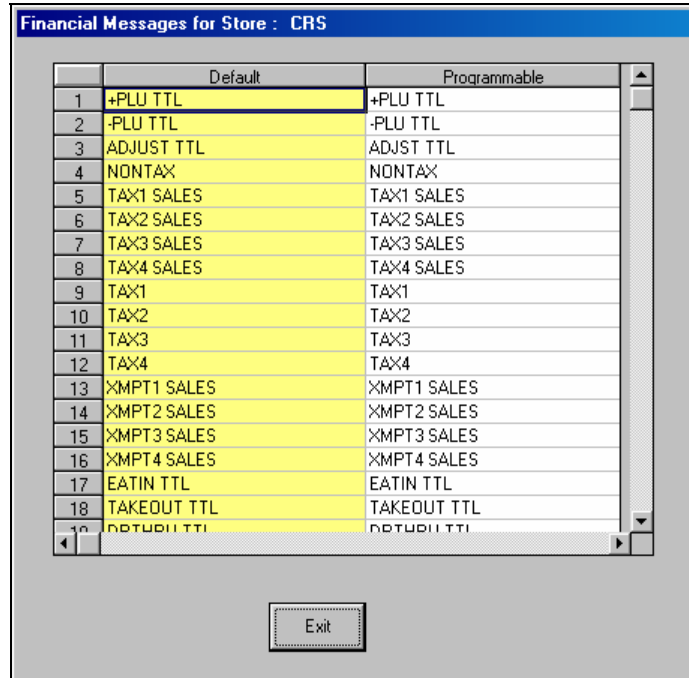

2. Use the scroll box at the right of the screen to view all of the descriptor fields.
3. Edit the descriptor fields by double clicking on the field, then type a new descriptor.
4. Click **Exit** to save changes and return to the main menu.

Clerk Messages

You can also program unique descriptors for clerk report totals. Follow the instructions on the screen, or refer to the *Samsung ER-5215M Operators and Program Manual* or the *Samsung ER-5200M/5240M Operators and Program Manual* for a complete description of your program options.

1. Choose **Clerk Messages** from the *Edit ECR Data* menu. The appropriate *Clerk Messages* dialog box displays:

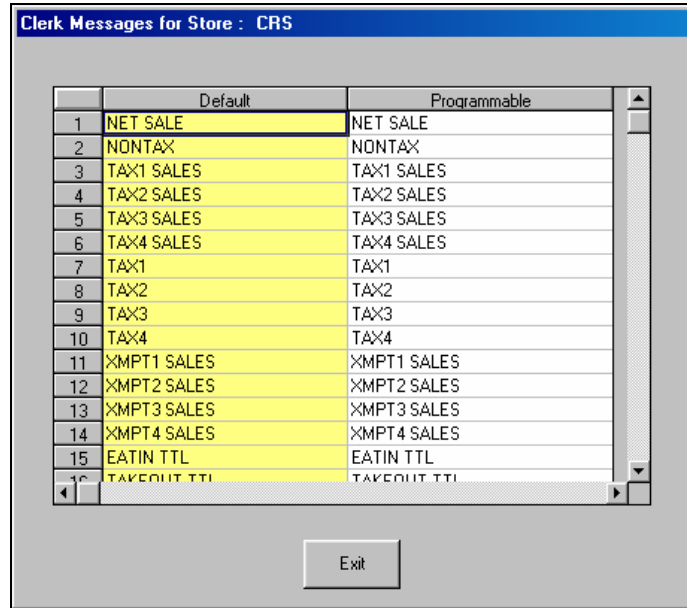

2. Use the scroll box at the right of the screen to view all of the descriptor fields.
3. Edit the descriptor fields by double clicking on the field, then type a new descriptor.
4. Click **Exit** to save changes and return to the main menu.

Misc.

NLU

NLUs are fixed keys on the keyboard (like traditional department keys) that access specific PLUs.

On the default keyboard, the ER-5215M has 5 or 15 NLUs; the ER-524M has 15 or 40 NLUs; and the ER-5200M has 117 NLUs. Each NLU key is assigned the same number PLU, i.e. NLU key number one is PLU #1. However, with this program, you can assign any PLU number you wish to any one of the NLU keys.

1. Choose **Misc** from the *Edit ECR Data* menu. Then from the cascading menu choose **NLU**. The appropriate *NLU Programming* dialog box displays:

NLU#	PLU#
1	1
2	2
3	3
4	4
5	5
6	6
7	7
8	8
9	9
10	10
11	11
12	12

Exit

2. Use the scroll box at the right of the screen to view all of the NLUs.
3. To edit an NLU, type the PLU number you wish the NLU to address in the appropriate field.
4. Click **Exit** to save changes and return to the main menu.

Tare Weights

Up to 5 tare weights can be pre-programmed and entered automatically during register operations. Follow the instructions on the screen, or refer to the *Samsung ER-5215M Operators and Program Manual* or the *Samsung ER-5200M/5240M Operators and Program Manual* for a complete description of your program options.

1. Choose **Misc** from the *Edit ECR Data* menu. Then from the cascading menu choose **Tare Weights**. The appropriate *Tare Weight Programming* dialog box displays:

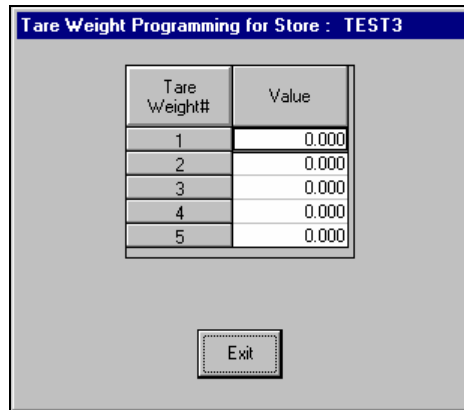

Tare Weight#	Value
1	0.000
2	0.000
3	0.000
4	0.000
5	0.000

Exit

2. Enter a weight (up to 9.999 lbs) for each tare.
3. Click **Exit** to save changes and return to the main menu.

COM Port Options

Set options for the communications when you are connecting optional hardware to the register. Follow the instructions on the screen, or refer to the *Samsung ER-5215 Operators and Program Manual* or the *Samsung ER-5240 Operators and Program Manual* for a complete description of your program options.

1. Choose **Misc** from the *Edit ECR Data* menu. Then from the cascading menu choose **COM Port 1 Option**. The *Serial Port Programming* dialog box displays:

	COM PORT 1	COM PORT 2
Baud Rate	9600	9600
Parity	None	Even
Data Bits	8	7
Stop Bits	1	1
Device Function	PC	Scanner
Initial Feeding Line	0	0
Ending Feeding Line	7	7
Initial Feeding Line	0	0
Print Line on Guest	0	0
Scale Type	NCI	NCI
Printer Type	Sam SRP-100	None
Pole Display Type	Epson	Epson

Exit

2. Fill the applicable fields for the device you are using. (Be sure to select the appropriate scale, printer, or pole display type, if necessary.)
 - Edit fields with drop-down list boxes by opening the list box and selecting from the available options.
 - Edit fields with numeric information by double clicking on the field, and then enter new data.
3. Click **Exit** to save changes and return to the main menu.

Keyboard Layout/Macros

Each key location on the register can be programmed for any available function. Follow the instructions on the screen, or refer to the *Samsung ER-5215M Operators and Program Manual* or the *Samsung ER-5200M/5240M Operators and Program Manual* for a complete description of your program options.

1. Choose **Misc** from the *Edit ECR Data* menu. Then from the cascading menu choose **Keyboard Layout/Macros**. The appropriate *Keyboard Locations* dialog box displays:

Keyboard Locations for Store: JAVATIME															
5200								5240 - 15 NLU				5240 - 40 NLU		5215	
	8	9	10	11	12	13	14	15	16						
1	HAMBU RGER	CALIFO RNIA	PHILLY	PICKLES	TOMAT O	TAX1	FSHIFT	PO1	CLERK						
2	CHEESE BURGE	PATTY MELT	GRILL CHICKE	MUSHR DOOMS	BACON	TAX2	CHECK #	RA1	F/S SUB						
3	DBL CHEESE	MUSHR DOM	DLX CHICKE	BLACK OLIVES	AMERIC AN	% 1	SERVIC E	VOID	F/S TEND						
4	BAC CHEESE	GRILLE D	BRD CHICKE	LETTUC E	SWISS CHEESE	% 2	ERRCO RR	MDSE RETUR	EATIN						
5	DBL BAC	GRILLE D HAM &	STEAK SANDWI	PEPPER S	FRIED ONIONS	PROMO	NOSALE	CANCEL	CHARG E3						
6	GILY BURGE	SWISS HOUSE	CLUB	SOUR CREAM	RAW ONIONS	CLEAR	PLU	1	CHARG E2						
7	FISH SANDWI	PIZZA BURGE	BLT	WHEAT BREAD	OFF SALE	[7]	[8]	[9]	VISA						
8	HAMBU RGER	CORDO N BLUE	PIZZA	GLASS OF POP	DART SUPPLI	[4]	[5]	[6]	CHECK						
9	ADD WAFFLE	NON-TA X	COFFEE	BOTTLE OF POP	CIGARE TTES	[1]	[2]	[3]	SUBTOT AL						
10	\$T TATOR	LUNCH SPECIAL	MILK	JUICE	PROMO	[0]	[00]	[.]	CASH						

MACRO 1 - 10			
	1	2	
1	[5]	<KLP>X	
2	[00]	[1]	
3	CASH	SUBTOTAL	
4		[3]	
5		SUBTOTAL	
6			
7			
8			
9			
10			
11			
12			
13			
14			
15			
16			
17			

To Change a Key Function

The dialog box depicts the keyboard layout. The current function for each location is displayed. Use the scroll bar at the bottom and right to view all of the key positions. Yellow locations are fixed and cannot be changed. The current function for each programmable location is displayed.

- ◆ To change a programmable location, open the Function Keys drop down list box and find the new function you wish to assign. Then double click on the position where you wish the function assigned.

Programming Macros

1. Each Macro can execute a series of key sequences. Select the Macro number (1-10) and the Macro Key Sequence cell, and then select the key on the keyboard the macro is to execute, and then click the **Set Macro Cell to Keyboard Cell** button.
2. To have the macro change lock positions for the next keystroke, first select the lock position option button. Next, select the next Macro Sequence cell, and then click the **Set Macro Cell to Keylock Position** command button.

Misc

Here you can set a cash-in-drawer limit, machine number, and a check change limit. Follow the instructions on the screen, or refer to the *Samsung ER-5215M Operators and Program Manual* or the *Samsung ER-5200M/5240M Operators and Program Manual* for a complete description of your program options.

1. Choose **Misc** from the *Edit ECR Data* menu. Then from the cascading menu choose **Misc**. The appropriate *Misc Programming* dialog box displays:

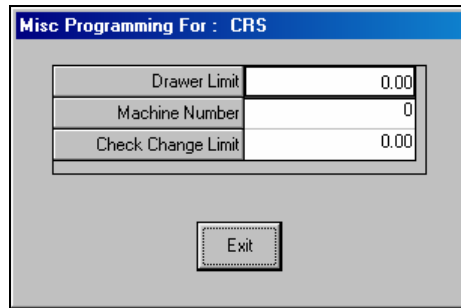

Misc Programming For : CRS	
Drawer Limit	0.00
Machine Number	0
Check Change Limit	0.00

Exit

2. Double click on the option you wish to edit, and then enter a new value.
3. Click **Exit** to save changes and return to the main menu.

Mix and Match

Up to 10 macros are available, each can execute up to 50 keystrokes. Follow the instructions on the screen, or refer to the *Samsung ER-5215M Operators and Program Manual* or the *Samsung ER-5200M/5240M Operators and Program Manual* for a complete description of your program options.

1. Choose **Mix and Match** from the *Edit ECR Data* menu. The appropriate *Mix and Match* dialog box displays:

	Description	Trip Level	Price
1	DISCOUNT1	3	1.00
2	DISCOUNT2	3	1.00
3	DISCOUNT3	3	1.00
4	DISCOUNT4	3	1.00
5	DISCOUNT5	3	1.00
6	DISCOUNT6	3	1.00
7	DISCOUNT7	3	1.00
8	DISCOUNT8	3	1.00
9	DISCOUNT9	3	1.00
10	DISCOUNT10	3	1.00

Exit

2. Set the trip level to indicate how many items to ring before the discount is applied. Set the discount amount in the price field. (As shown above, a \$1 discount will apply after three items are registered.)
3. Click **Exit** to save changes and return to the main menu.

Stock

Upload stock from the ECR first. Items flagged as inventory items will populate this screen. Edit quantities as needed, and then download to the ECR. You can use the “Add This PLU Item” button to populate this screen as well

Note: If you add a PLU to this grid that is not flagged in the PLU status as an inventory item, you can still add a quantity here. When stock is downloaded to the ECR, no totals will appear on that item at the ECR.

1. Choose **Stock** from the *Edit ECR Data* menu. The *Stock Programming* dialog box displays with a list of PLU Stock items and it's current stock level.

PLU#	Status	Descriptor	Stock
00000000000001	A	GROCERY	0.00
00000000000002	A	GROCY NON-TX	0.00
00000000000003	A	DAIRY	0.00
00000000000004	C	CANNED GOODS	200.00
00000000000005	A	TAX 2 ITEM	0.00
00000000000006	A	OPEN NEGATIV	0.00
00000000000007	A	BUTTERFINGER	0.00
00000000000008	A	Regular Gas	0.00
00000000000009	A	Premium Gas	0.00
00000000000010	A	Diesel Fuel	0.00
00000000000011	A	ýDýýL	0.00
00000000000012	A	AUTO PARTS	0.00
00000000000013	A	PLU13	0.00
00000000000014	A	PLU14	0.00
00000000000015	A	DELI SCALE	0.00
00000000000016	A	DELI SCALE	0.00

Cells in Yellow can not be Edited.

Exit Status: A=Active, C=Changed, D=Deleted Set All Stock to Zero

2. You can edit quantities here and send to the ECR, or you can reset all quantities to zero by clicking the **Set All Stock to Zero** button.
3. When complete, click **Exit** . These quantities can be sent to the register from Communications/Send Programs to ECR (Download).

Communications

- ◆ Choose **Communications** from the Main menu to initiate communications with a Samsung ER-5200M series ECR.

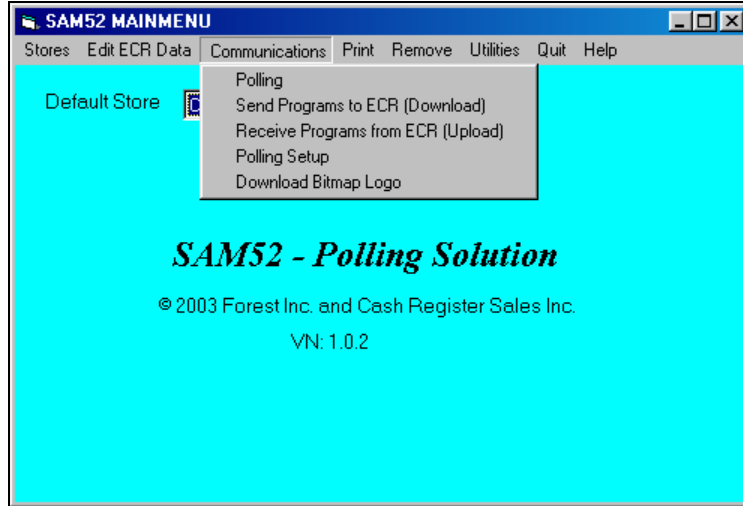

Polling

1. Choose **Polling** from the *Communications* menu to connect to the store to poll reports. The *SAM52M Polling* dialog box will display.

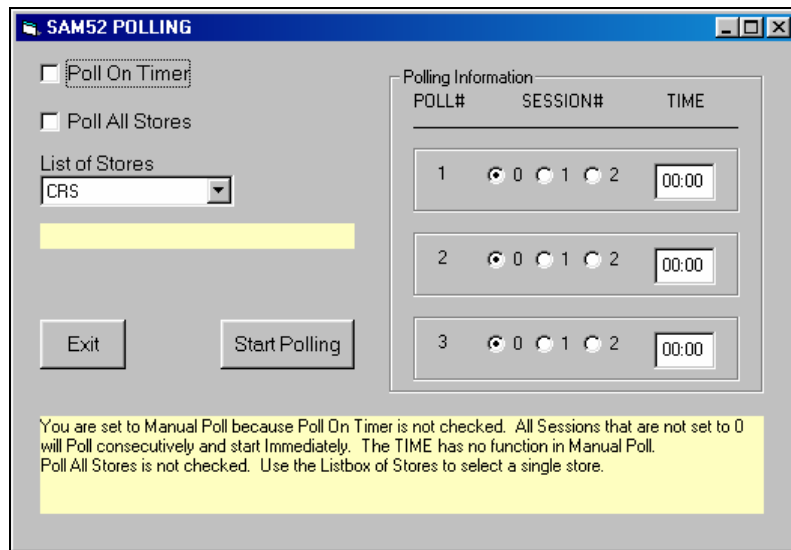

Note: Polling setup file must be completed first. See "Polling Setup File" on page 41.

2. Complete the fields on the Polling Routine window according to the table below:

Field Name	Required /Optional	Description/Instructions
<i>Poll On Timer</i>	O	Select the Poll On Timer checkbox to start polling in consecutive order beginning with Poll 1 at the defined time. If not selected, polling is manual and will begin immediately.
<i>Poll All Stores</i>	O	Select the <i>Poll All Stores</i> checkbox to poll all stores. If not selected, enter an individual store to poll in the <i>Listbox of Stores</i> field.
<i>Listbox of Stores</i>	O	Select an individual store to poll if the <i>Poll All Stores</i> check box is not selected.
<i>Timer</i>	O	Enter the military time the polling session is to begin if unattended polling is to be done.
<i>Session</i>	R	Select the polling session, 0 - 2. Polling will proceed in consecutive order by session number.

3. Click the **Start Polling** button to begin polling; click **Exit** to exit the dialog box.

Note: The polling setup must be completed before a store can be polled. See “Polling Setup File” on page 41.

Send Programs to ECR (Download)

1. Choose **Send Programs to ECR (Download)** from the *Communications* menu to send program information from the working store, to the ECR of the working store.

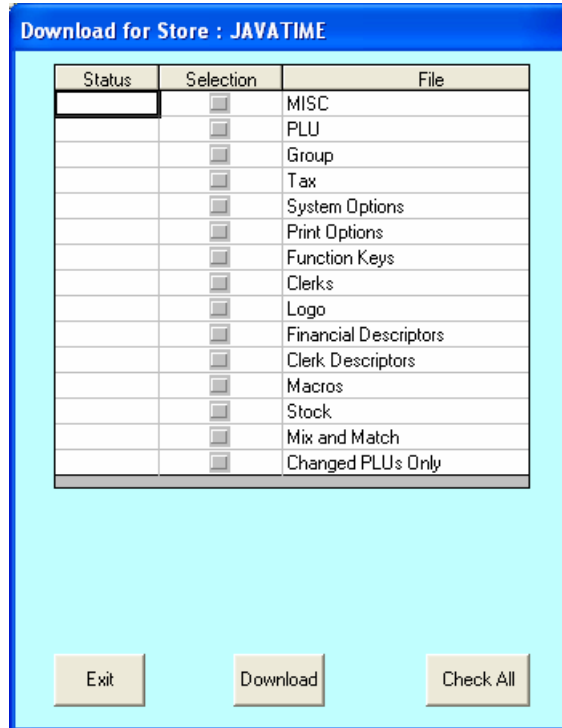

2. From the *Download* dialog box, select the program components you wish to send to the ECR. (Click **Check All** to select all components.) A check mark means the item is selected.
3. Click the **Download** button to initiate the download to the ECR; click **Exit** to exit the window. The *Status* field will monitor the progress of the download for each program component. *Passed* will display in green when the program is successfully downloaded; *Fail* will display in red if the download is unsuccessful.

Receive Programs from ECR (Upload)

1. Choose **Receive Programs from ECR (Upload)** from the *Communications* menu to receive program information from the ECR for the working store. When you execute this function, any program data that was on the hard disk previously will be overwritten by the new data.

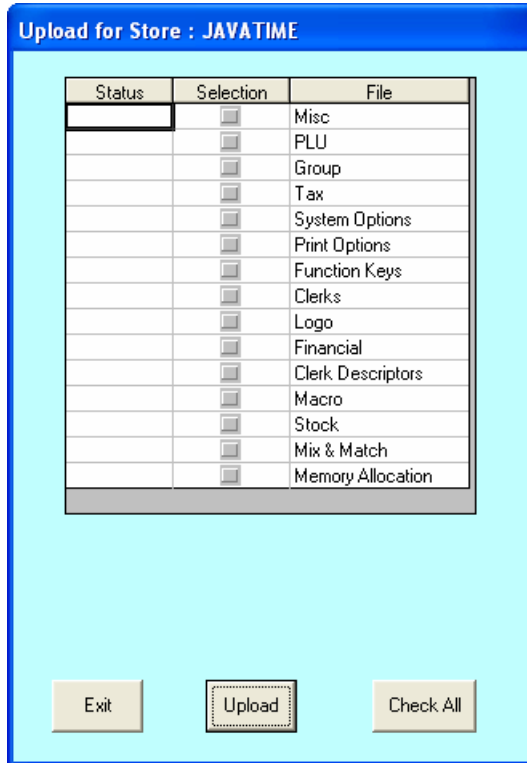

2. From the *Upload* dialog box, select the program components you wish to send to the ECR. (Click **Check All** to select all components.) A check mark means the item is selected.
3. Click the **Upload** button to initiate the download to the ECR; click **Exit** to exit the window. The *Status* field will monitor the progress of the upload for each program component. *Passed* will display in green when the program is successfully uploaded; *Fail* will display in red if the upload is unsuccessful.

Polling Setup File

1. Choose **Polling Setup File** from the *Communications* menu to define the reports to be taken when polling is initiated.

File	X1	Z1	X2	Z2
Financial	<input type="checkbox"/>	<input type="checkbox"/>	<input type="checkbox"/>	<input type="checkbox"/>
Time	<input type="checkbox"/>	<input type="checkbox"/>	<input type="checkbox"/>	<input type="checkbox"/>
PLU	<input checked="" type="checkbox"/>	<input type="checkbox"/>	<input type="checkbox"/>	<input type="checkbox"/>
Clerks	<input type="checkbox"/>	<input type="checkbox"/>	<input type="checkbox"/>	<input type="checkbox"/>
Groups	<input checked="" type="checkbox"/>	<input type="checkbox"/>	<input type="checkbox"/>	<input type="checkbox"/>
Day			<input type="checkbox"/>	<input type="checkbox"/>
Stock	<input type="checkbox"/>	<input type="checkbox"/>		
Open Check	<input type="checkbox"/>	<input type="checkbox"/>		

Exit

2. Click the **Session 1** or **Session 2** tabs to display the reports for the session.
3. At the heading of each column, view the type of report (i.e. X1, Z1, etc.) Then, indicate by selecting the check boxes in the column for the specific reports of that type you wish to take.
4. Click **Exit** to save changes and return to the main menu.
5. To poll, see “Polling” on page 37, “Send Programs to ECR (Download)” on page 39, or “Receive Programs from ECR (Upload)” on page 40.

Download Bitmap Image

Preparing a Graphic Logo Bitmap for an ER-5200M Series ECR

The image must be black/white bitmap, 384 x 192 pixels, and 10 Kbytes or less in size. If your bitmap file does not meet these specifications, follow the instructions below and use Microsoft Paint to format your image.

1. Open MS Paint.
2. Open the image file you wish to use.
3. Choose **Attributes** from the **Image** menu. The **Attributes** dialog box displays.

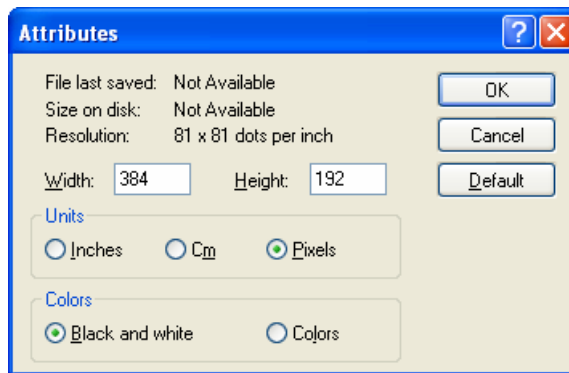

4. The image dimensions must be 384 pixels wide by 192 pixels high. If the image size in pixels is greater than the maximum, you must resize your image.
 - a. Click **OK** to exit the Attributes dialog.
 - b. Select your image. (Choose **Select All** from the **Edit** menu.)
 - c. Using the handles of the selected image, resize the image. Keep the image in the upper left corner of the screen.
 - d. Choose **Attributes** from the **Image** menu. The **Attributes** dialog box displays again. Enter 384 in the **Width** field; enter 192 in the **Height** field; select **Pixels** as the unit. Click **OK** to exit the dialog box.
 - e. Your image will be cropped to the 384 x 192 pixel size. If you cropped part of the image you wish to keep, you can undo (Ctrl + Z) and try again. You may have to experiment a bit to resize the image inside the 384 x 192 pixel limit.
5. After the image is sized, select **Black and white** in the **Attributes** dialog.
6. Save your image and confirm that the size is 10k or less.

Download a Graphic Logo to an ER-5200M Series ECR

1. Choose **Download Bitmap Image** from the *Communications* menu. The appropriate *Download Bitmap* dialog box displays:

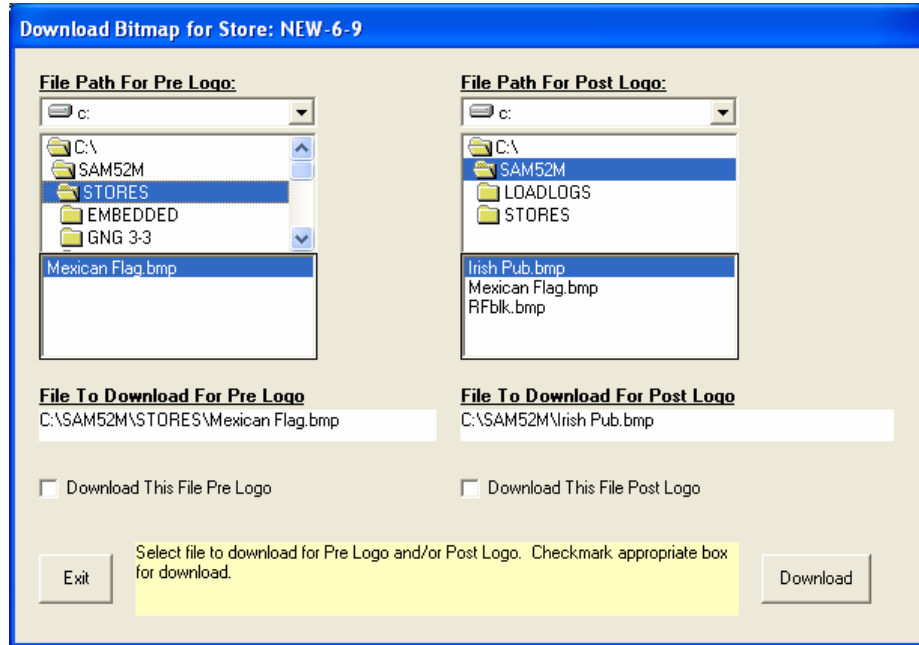

2. Select the folder where the bitmap file you wish to use is located. Select the Pre Logo bitmap file on the left and select the Post Logo bitmap on the right.
3. Select the *Download This File Pre Logo* and/or *Download This File Post Logo* checkboxes.
4. Click the **Download** button. When the logo loads successfully, the download completed message displays after a short delay.

Printing the Logo Image – ER-5200M Settings Series ECR

Three addresses in Print Option Programming affect graphic logo printing:

Option #28 – Add the value of 1 to address 28 if you wish to print the pre graphic logo on the receipt. Add the value of 2 to address 28 if you wish to print the post graphic logo on the receipt.

Option #29 – Add the value of 1 to address 29 if you wish to print the pre graphic logo on the guest check. Add the value of 2 to address 29 if you wish to print the post graphic logo on the guest check.

Option #30 – Add the value of 1 to address 30 if you wish to print your custom bitmap instead of the default bitmap “Thank You – Your Receipt”. Add the value of 2 to address 30 if you wish to print your custom bitmap instead of the default bitmap “Call Again”.

Print Option Flowchart (P Key Lock Position)

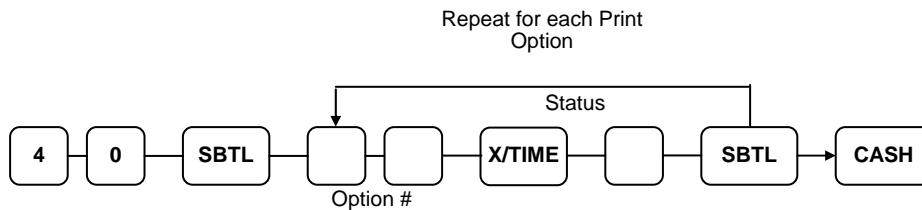

Print

- ◆ Choose **Print** from the Main menu to access the printing utilities described below.

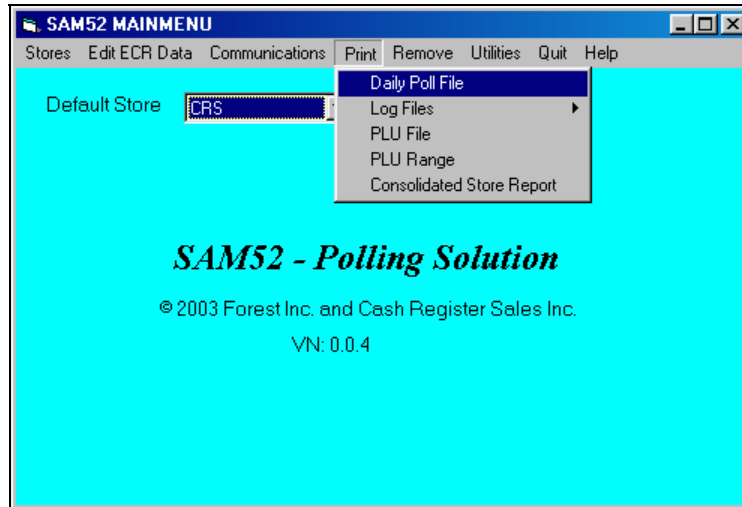

Daily Poll File

1. Choose **Daily Poll File** from the *Print* menu to print out the poll file of a given day. The *Daily Poll* dialog box displays.

PLU#	Count	Amount
PLU1	1.00	1.00
PLU2	1.00	1.00
PLU3	1.00	1.00
PLU4	1.00	1.00
PLU5	1.00	1.00
PLU6	0.00	0.00
PLU7	0.00	0.00
PLU8	0.00	0.00
PLU9	0.00	0.00
PLU10	0.00	0.00

2. Complete the *Daily Poll* dialog box according to the table below:

Field Name	Required /Optional	Description/Instructions
<i>Polling Date</i>	R	Select the polling date from the drop-down list box.
<i>Zero Skip</i>	O	Select the Zero Skip check box if you wish totals with zero values skipped.
<i>Report Type</i>	O	Select the report type from the drop-down list box. If no report type is selected, <i>SAM52M</i> will display all reports for the specified date and key lock mode.
<i>Keylock Mode</i>	O	Select the mode of the report.. If no key lock mode is selected, <i>SAM52M</i> will display all reports for the specified date and report type.
<i>Grid Lines</i>	O	Click the <i>Grid Lines</i> button to print/display the selected report with or without grid lines
<i>White/Gray</i>	O	Click the <i>White/Gray</i> button to print/display the selected report with or without shaded fields.

3. Click the **Load Table** button to view the selected report.
4. With the report in view, click the **Print Table** button to print the report.
5. Click **Exit** to return to the main menu.

Log Files

For error checking you can choose **Log File** from the *Print* menu to print out the upload, download or poll log file of a given day.

Note: Log files are stored in ord by mm/dd/yyyy. For example, if you wish to view logs and you have files from the same day in different years, they will as:

06/06/2007
06/06/2008
06/06/2009
06/07/2007
06/07/2008, etc.

Uploads

1. Choose **Log Files** from the *Print* menu, then choose **Uploads** to view and/or print the uploads of a given day. The *Upload Log File Report* dialog box for the selected store displays.

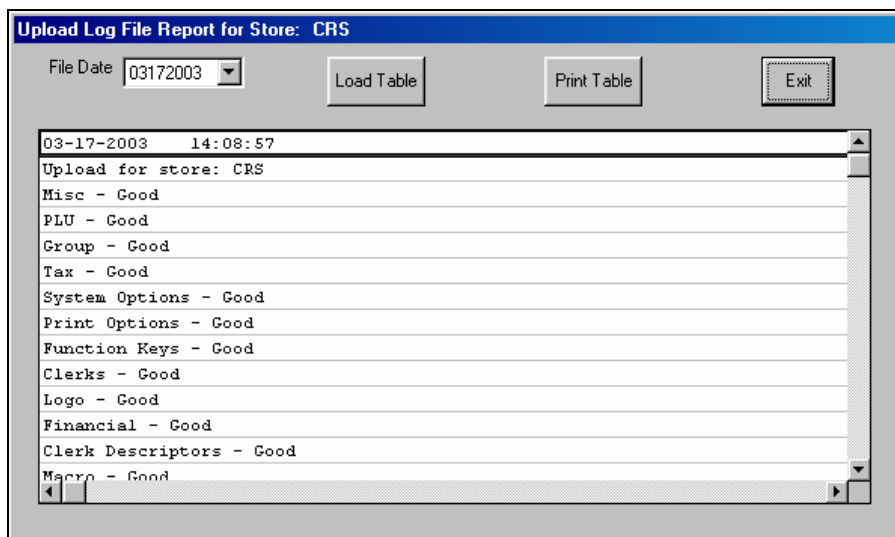

2. Type or select a date from the *File Date* list box.
3. Click the **Load Table** button to load the table for the selected file date.
4. Click the **Print Table** button to print the table.

Downloads

Note: Log files are stored in ord by mm/dd/yyyy. For example, if you wish to view logs and you have files from the same day in different years, they will as:

06/06/2007
06/06/2008
06/06/2009
06/07/2007
06/07/2008, etc.

1. Choose **Log Files** from the *Print* menu, then choose **Downloads** to view and/or print the uploads of a given day. The *Download Log File Report* dialog box for the selected store displays.

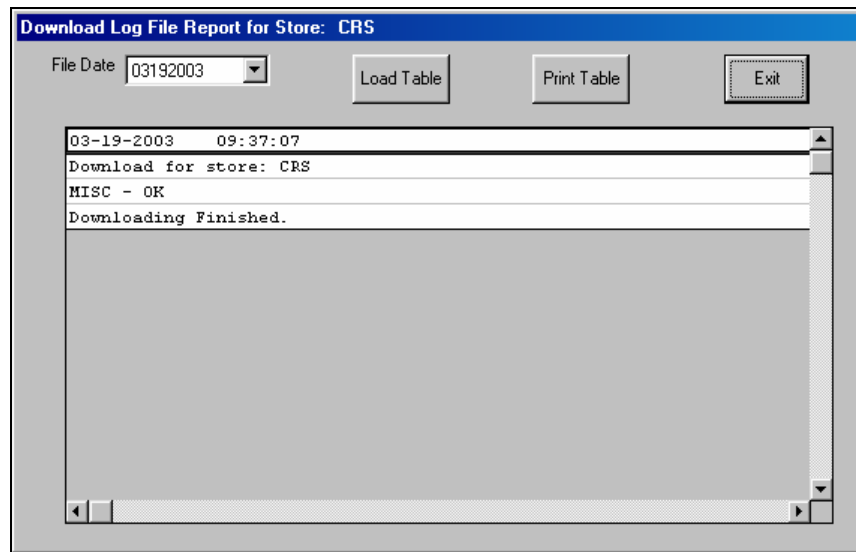

2. Type or select a date from the *File Date* list box.
3. Click the **Load Table** button to load the table for the selected file date.
4. Click the **Print Table** button to print the table.

Polling

1. Choose **Log Files** from the *Print* menu, and then choose **Polling** to view and/or print the polling activity of a given day. The *Download Log File Report* dialog box for the selected store displays.

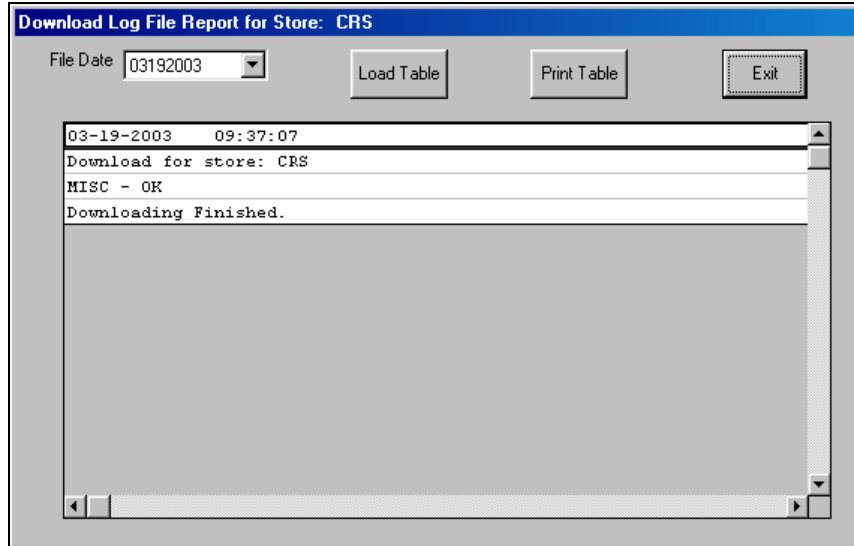

2. Select the polling date from the drop-down list box.
3. Click the **Load Table** button to view the selected file date log.
4. With the report in view, click the **Print Table** button to print the report.
5. Click **Exit** to return to the main menu.

PLU File

1. Choose **PLU File** from the *Print* menu to display and print out the PLU file of the working store. The *PLU File* dialog box displays.

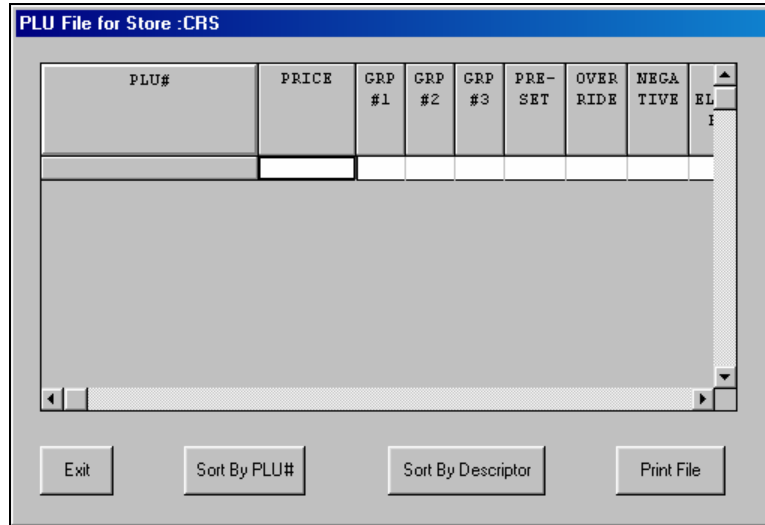

2. Click the **Sort by PLU #** button to view the file sorted by PLU #; click the **Sort by Descriptor** button to view the file sorted by descriptor.
3. Click the **Print File** button to print the file.
4. Click **Exit** to return to the main menu.

PLU Range

1. Choose **PLU Range** from the *Print* menu to display and print out a specific range of the PLU file of the working store. The *PLU File* dialog box displays.

PLU File for Store :CRS

From PLU To PLU

PLU#	PRICE	GRP #1	GRP #2	GRP #3	PRE-SET	OVER-RIDE	NEGA-TIVE	FS ELICIT-BLE
------	-------	--------	--------	--------	---------	-----------	-----------	---------------

Exit Load Grid Print File

2. Enter or select the From PLU and To PLU numbers.
3. Click the **Load Grid** button to view the selected PLUs .
4. Click the **Print File** button to print the file.
5. Click **Exit** to return to the main menu.

Consolidated Store Report

1. Choose **Consolidated Store Report** from the *Print* menu to display and print out the Consolidated financial, PLU and group reports for all stores. The *Consolidated Store Report* dialog box displays.

FINANCIAL REPORT	JAVATIME	GNG 5-5	GNG 5-2	TOTAL
01/06/2002 To 06/06/2008				
+PLU TTL				
Count	9.00		15.00	24.00
Amount	5.25		376.63	381.88
ADJST TTL				
Count	9.00		15.00	24.00
Amount	5.25		376.63	381.88
NONTAX				
Count			1.00	1.00
Amount			15.00	15.00
TAX1 SALES				
Amount	11.25		361.63	372.88
TAX1				
Amount	0.73		9.30	10.03

2. Chose the Polling Date from the drop down list for the reports you wish to consolidate.
3. Chose the Report Type (Financial, PLU, or Groups) from the drop down list for your consolidated report.
4. Double-click on the store for the Available Stores list to display the data on the table.
5. Click on Load Table to load the consolidated store report.
6. Click on the Grid Lines icon to toggle between displaying grid lines on the table and not.
7. Click on the White/Gray icon to toggle between showing the descriptors in white or gray.
8. Click on the Print Table icon to print the consolidated store report.
9. Click on Exit to return to the main menu.

Remove

Old Poll Files

1. Choose **Old Poll Files** from the *Remove* menu to delete unwanted poll files. The *Remove Old Polling Files* dialog box displays.

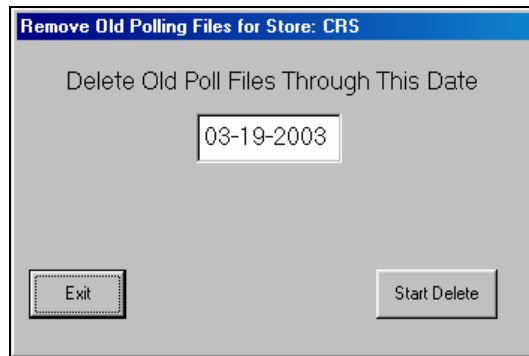

2. Enter the date through which you want old poll files deleted. The message "FINISHED" will display when completed.
3. Click **Exit** to return to the main menu.

Log Files (Upload, Download, Poll)

1. Choose **Log Files (Upload, Download, Poll)** from the *Remove* menu to delete unwanted poll log files. The *Remove Old Log Files* dialog box will display.

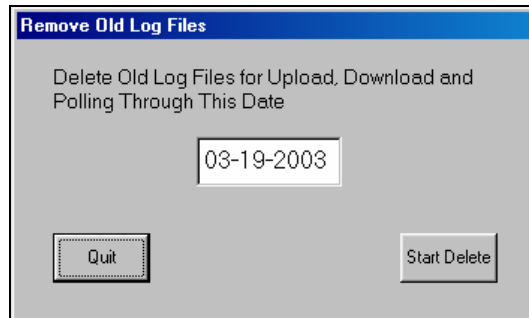

2. Enter the date through which you want old log files deleted. The message "FINISHED" will display when completed.
3. Click **Quit** to return to the main menu.

Utilities

- ◆ Choose **Utilities** from the Main menu to access the utilities described below.

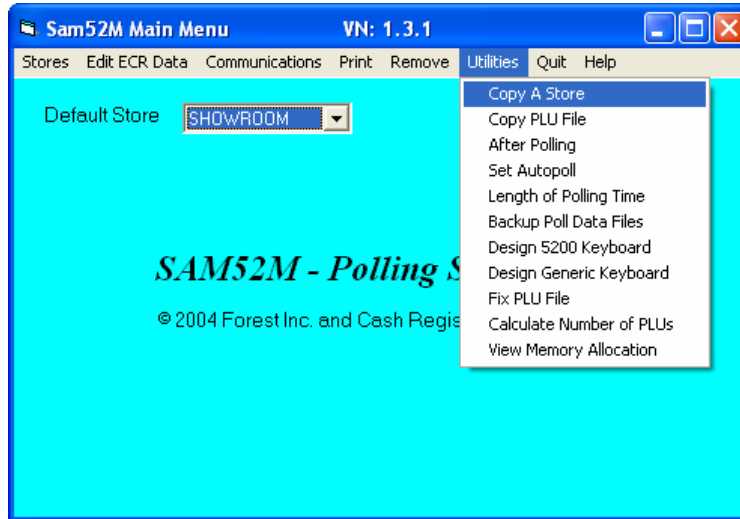

Copy a Store

Use the Copy a Store function to create a new store with the identical attributes of an existing store.

1. Choose **Copy a Store** from the *Utilities* menu.

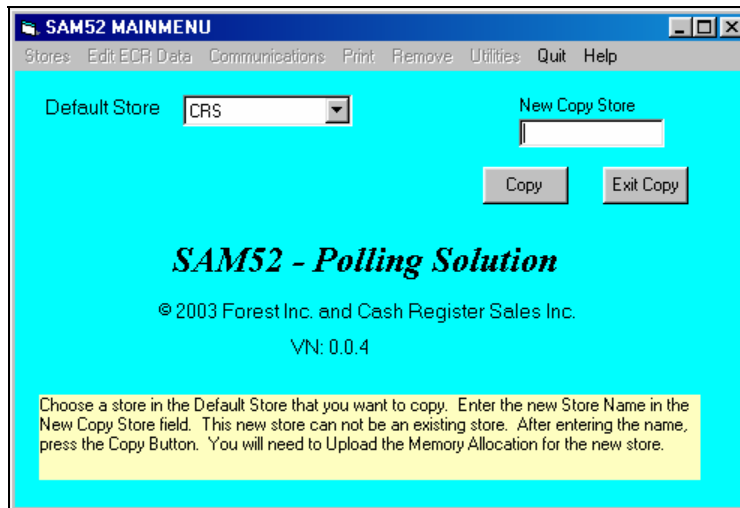

2. Select the store that you wish to copy from by clicking the Default Store field drop-down list box.
3. Enter the name of the store you wish to create in the *New Copy Store* field.
4. Click the **Copy** button to create a new store with identical attributes as the default store.
5. Click the **Exit Copy** button to return to the main menu.

Copy PLU File

Use the Copy a PLU File function to copy a PLU file to an individual store or all stores.

1. Choose **Copy a PLU File** from the *Utilities* menu.

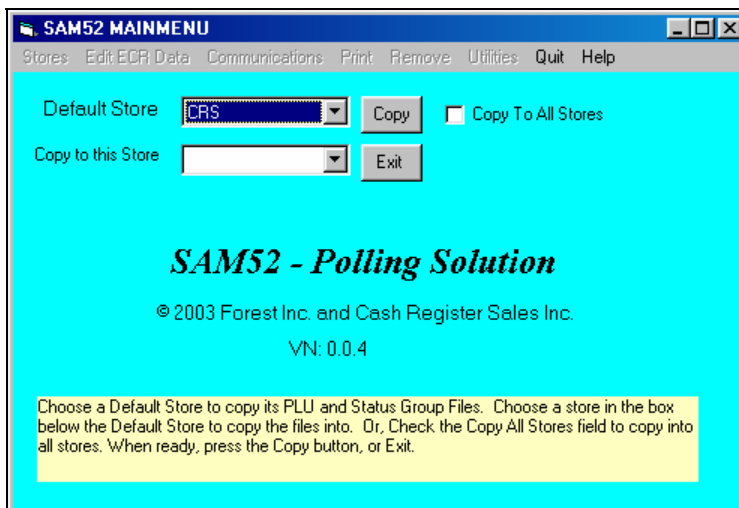

2. Select the store that you wish to copy the PLU file from by clicking the Default Store field drop-down list box.
3. Select the name of the store you wish the PLU file copied to in the *Copy PLU File to this Store* field, or click the *Copy To All Stores* check box.
4. Click the **Copy** button to copy the PLU file to the selected store or all stores.
5. Click the **Exit** button to return to the main menu.

After Polling

You can program SAM52M to send your polled files to the printer immediately after polling, or have the polled files sent automatically by e-mail to a preselected e-mail address.

Note: Not all ISP's are compatible with the After Poll feature of SAM2000. For example, AOL is not compatible with After Polling; AT&T and Road Runner have been tested.

1. Choose **After Polling** from the *Utilities* menu. The *After Polling* dialog box for the selected store displays.

Fill these fields only if the "E-mail the Polled file after Polling to the E-Mail Address below" check box is selected.

2. Click on the check boxes to select Printing or E-mailing the polled file after polling.
3. Select Your Internet Connection from the drop down list. All connections set up in your PC should display for you to choose from.
4. Type in your Outgoing Mail Host Name (SMTP) in the appropriate location. See **"Error! Reference source not found."** on the next page. If you have trouble locating the host name, please contact your e-mail provider. The host names vary greatly depending on the provider.
5. Type in your E-mail Account Logon Name.
6. Type in your E-mail Account Password.
7. Type in your E-mail Address.
8. Type in the address you wish to send the polled reports to in the text box labeled Send File to this E-mail Address.
9. Click on Exit to return to the main menu and save your changes.
10. Start Polling. After polling is completed, the polled file will be emailed to the selected address in the After Polling area.

Set Auto Poll

You can set *SAM52M* to automatically go into polling mode when the program is started. You can also set *SAM52M* to automatically close when polling is completed.

1. Choose **Set Autopoll** from the *Utilities* menu. The *Set to Automatically Poll* dialog box displays.

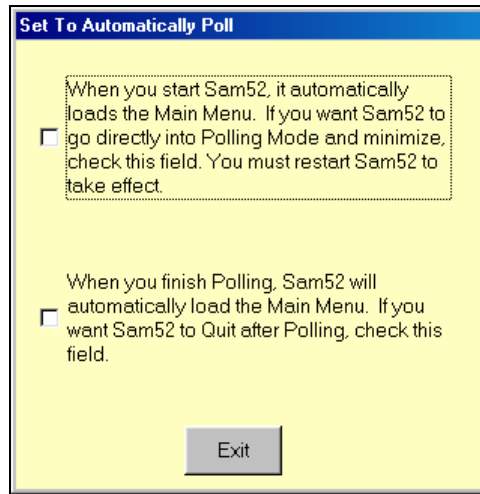

2. Select the first check box if you wish to automatically poll when *SAM52M* is executed. Select the second check box if you wish to close *SAM52M* automatically when polling is completed.
3. Click **Exit**.
4. Close *SAM52M* and then restart it for changes to take effect.

Length of Polling Time

You can set a time period that SAM52M will wait to successfully poll each report. Leave this value at '0' unless you encounter difficulty polling.

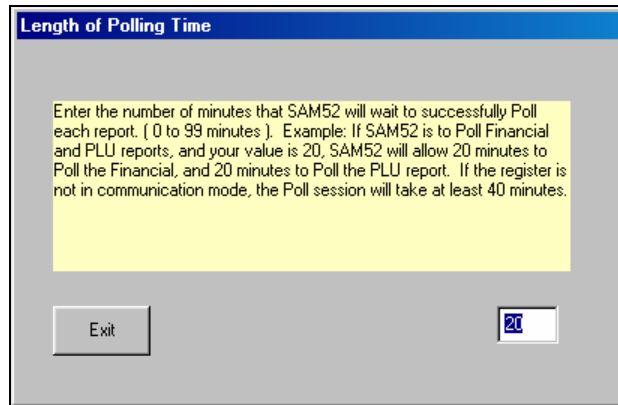

The screenshot shows a dialog box titled "Length of Polling Time". It contains a yellow text box with the following instructions: "Enter the number of minutes that SAM52 will wait to successfully Poll each report. (0 to 99 minutes). Example: If SAM52 is to Poll Financial and PLU reports, and your value is 20, SAM52 will allow 20 minutes to Poll the Financial, and 20 minutes to Poll the PLU report. If the register is not in communication mode, the Poll session will take at least 40 minutes." Below the text box, there is an "Exit" button on the left and a text input field on the right containing the number "20".

Backup Poll Data Files

Use this utility to backup polled data files to another disk drive. Follow the screen instructions.

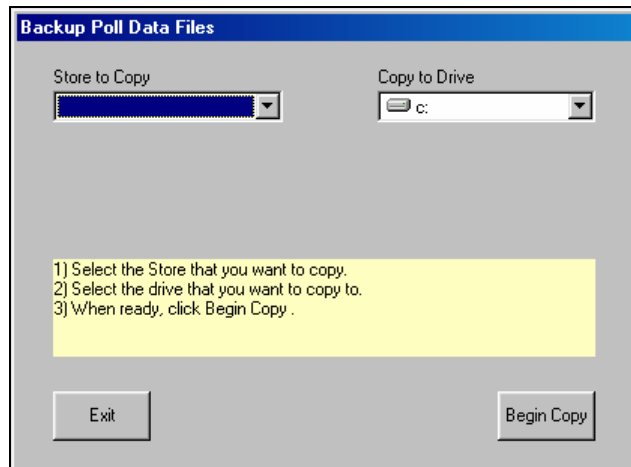

The screenshot shows a dialog box titled "Backup Poll Data Files". It features two dropdown menus: "Store to Copy" and "Copy to Drive". The "Copy to Drive" menu is currently set to "c:". Below the menus is a yellow text box with the following instructions: "1) Select the Store that you want to copy.
2) Select the drive that you want to copy to.
3) When ready, click Begin Copy." At the bottom of the dialog, there are two buttons: "Exit" on the left and "Begin Copy" on the right.

Design 5200M Keyboard

This utility allows you to design and print a key legend sheet for the ER5200M flat keyboard. If you are using a color inkjet printer and legal size paper, you can print a high-quality keyboard suitable for your installation.

1. Choose **Design 5200 Keyboard** from the *Utilities* menu. The appropriate *Keyboard* dialog box displays:

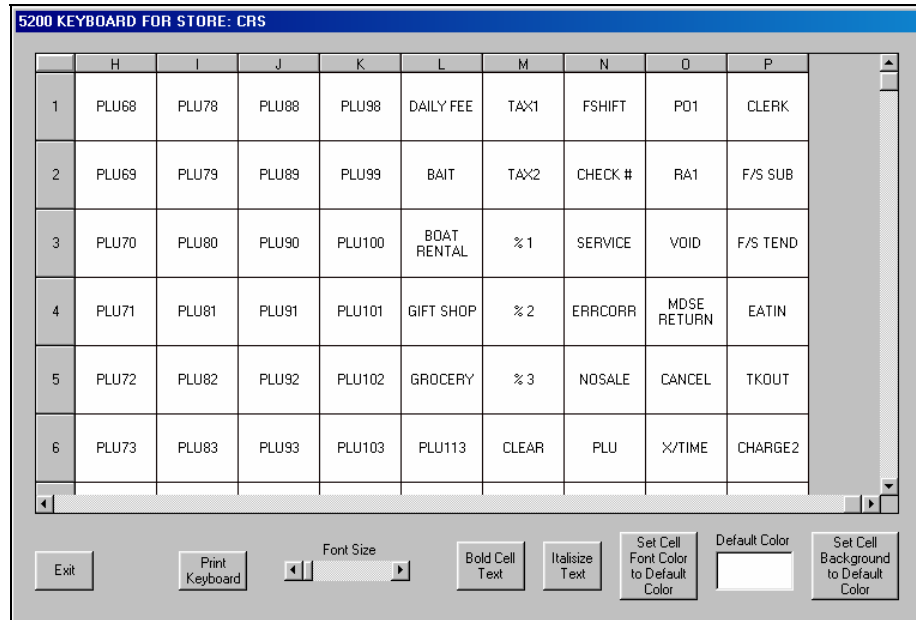

2. The dialog box depicts the keyboard layout. Use the scroll bar at the bottom and right to view all of the key positions.
3. Move the cursor the position you wish to edit and click. Type the text for the item. The text will automatically center when a new position is selected.
4. Click on the **Default Color** display to choose the default color. Click on one of the color samples and click on **OK** to set the color selected as default.
5. Select a key position or group of key positions and click on the **Set Cell Text Font Color to Default Color** icon to set the cell(s) text to the color selected as default.
6. Select a key position or group of key positions and click on the **Set Cell Background to Default Color** icon to set the cell(s) background to the color selected as default.
7. Select a key position or group of key positions and click on the **Bold Cell Text** or **Italize Text** icon to display the cell(s) text to Bold or Italics. Click on the icon again to reverse the change.
8. Select a key position or group of key positions and modify the cell(s) font size with the **Font Size** scroll bar.
9. Click on the **Print Keyboard** icon to print the keyboard.
10. Click **Exit** to save changes and return to the main menu.

Design Generic Keyboard

This utility allows you to design and print keychecks for the ER-5215/ER-5240. If you are using a color inkjet printer, you can print a high-quality keychecks suitable for your installation.

1. Choose **Design Generic Keyboard** from the *Utilities* menu. The appropriate *Keyboard* dialog box displays:

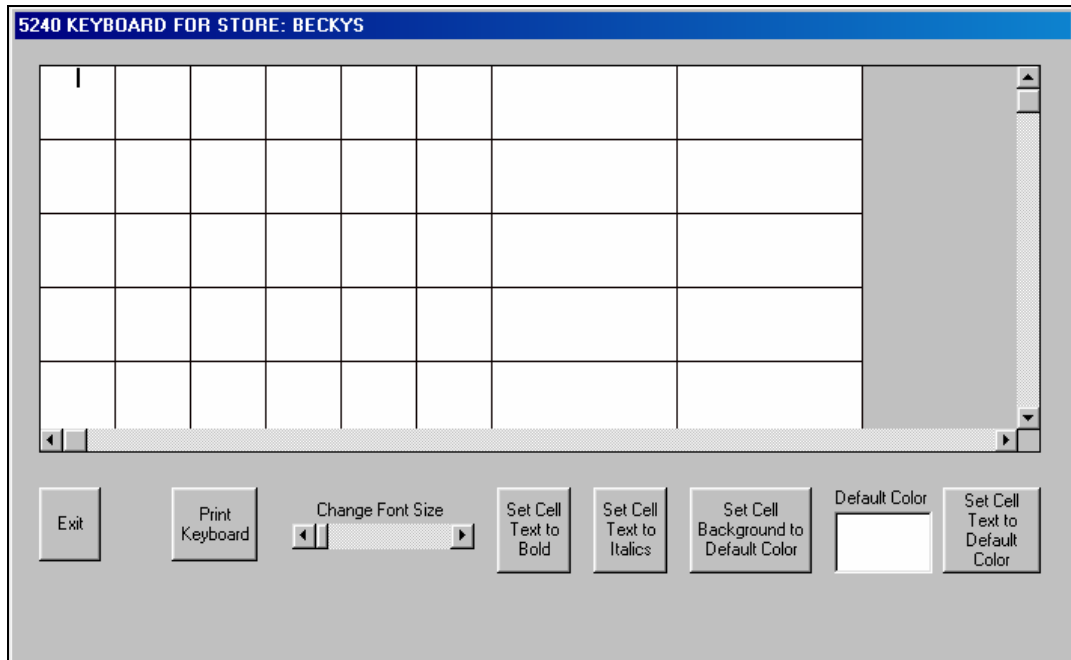

2. The dialog box displays a matrix of single and double size keychecks. Use the scroll bar at the bottom and right to view the entire matrix.
3. Move the cursor the position you wish to edit and click. Type the text for the item. The text will automatically center when a new position is selected.
4. Click on the **Default Color** display to choose the default color. Click on one of the color samples and click on **OK** to set the color selected as default.
5. Select a key position or group of key positions and click on the **Set Cell Text Font Color to Default Color** icon to set the cell(s) text to the color selected as default.
6. Select a key position or group of key positions and click on the **Set Cell Background to Default Color** icon to set the cell(s) background to the color selected as default.
7. Select a key position or group of key positions and click on the **Bold Cell Text** or **Italicize Text** icon to display the cell(s) text to Bold or Italics. Click on the icon again to reverse the change.
8. Select a key position or group of key positions and modify the cell(s) font size with the **Font Size** scroll bar.
9. Click on the **Print Keyboard** icon to print the keychecks.
10. Click **Exit** to save changes and return to the main menu.

Fix PLU File

This utility removes bad PLU record and duplicate PLUs. Review the detailed instructions on the screen

1. Choose **Fix PLU File** from the *Utilities* menu. The *Fix PLU File* dialog box for the selected store displays.

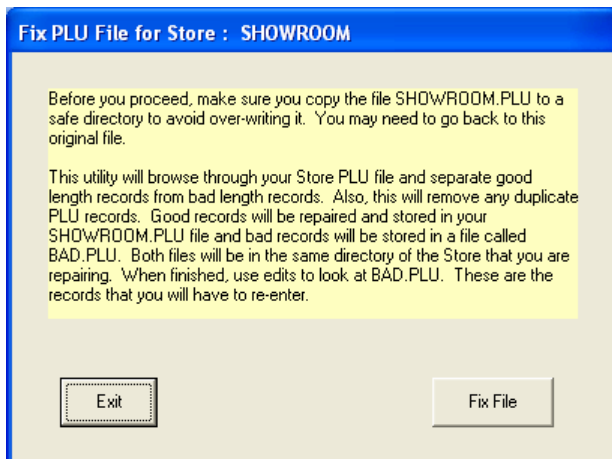

2. Click **Fix File**.
3. Click the **Exit** button to return to the main menu.

Calculate Number of PLUs

You can view the total number of PLUs in the database. The number of changed and deleted PLUs are tracked.

1. Choose **Calculate Number of PLUs** from the *Utilities* menu. The *Total PLUs* dialog box for the selected store displays.

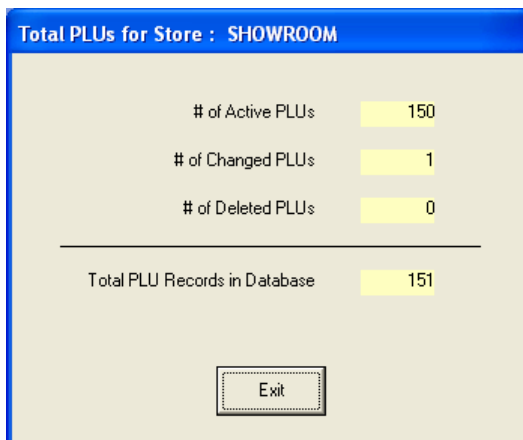

2. Click the **Exit** button to return to the main menu.

View Memory Allocation

1. Choose **View Memory Allocation** from the *Utilities* menu to display the memory allocation of the store's ECR.

Memory Allocation for Store: SHOWROOM

Allocated PLUs	1000
Allocated Clerks	15
Allocated Groups	20
Allocated Checks	20
Allocated Check Lines	50
Check Type is:	Soft
Allocated Mix & Match	20
Total Memory	1218720
Used Memory	152895

Exit

2. Click **Exit** to return to the main menu.

Quit

- ◆ Choose **Quit** from the Main menu to exit *SAM52M For Windows*.

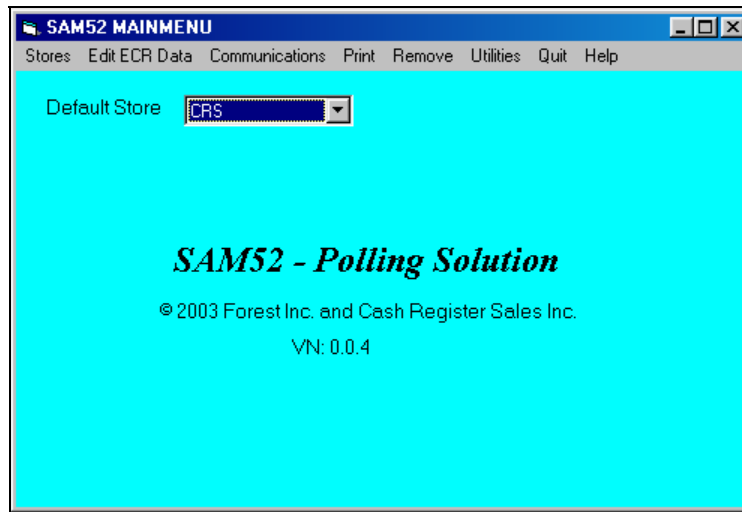

Appendices

Structure Of Stores

When you create a new store, you actually create a new sub-directory under the directory *SAM52M* for the store. If you create a store named **BIGBOYS**, the following will be created:

1. A directory named `\SAM52M\STORES\BIGBOYS`
This directory holds all the programming files for this store.
2. A directory named `\SAM52M\STORES\BIGBOYS\POLL`
This directory holds all the daily polling files for this store.

File Definitions

<u>File Extension</u>	<u>Definition</u>
.plu	PLU
.gru	group
.tax	tax
.syo	system options
.pro	print option
.fky	function key
.clk	clerk
.lgo	logo description
.fin	financial descriptors
.ckd	clerk logo
.mro	macro
.msc	misc
.mm	mix and match
.pol	(in polling folder) polled reports file
.tpl	(in polling folder) temporary polling file

SAM52M PLU File Structure

<Storename>.PLU		
<u>FIELD</u>	<u>START</u>	<u>LENGTH</u>
STATUS	1	1 (A,C,D)
PLU#	2	4
DESCRIPTION	6	12
GROUP1	18	2
GROUP2	20	2
GROUP3	22	2
NEGATIVE ITEM	24	1
FOOD STAMP	25	1
TAX4	26	1
TAX3	27	1
TAX2	28	1
TAX1	29	1
OVERRIDE PRESET	30	1
PRESET	31	1
AUTO SCALE	32	1
SCALABLE	33	1
DISABLE	34	1
INVENTORY	35	1
GALLONAGE	36	1
NON-ADD# COMP	37	1

<u>FIELD</u>	<u>START</u>	<u>LENGTH</u>
SINGLE ITEM	38	1
HASH	39	1
DISABLE PROMO	40	1
PRINT PRICE/CHECK	41	1
PRINT PRICE/RECEIPT	42	1
PRINT ON CHECK	43	1
PRINT ON DISPLAY	44	1
PRINT ON RECEIPT	45	1
COMP. CONDIMENT	46	1
CONDIMENT	47	1
Not Used	48	1
Not Used	49	1
Not Used	50	1
Not Used	51	1
Not Used	52	1
PRINT ON JOURNAL	53	1
PRESET OVER-MGT	54	1
RESET COUNTER	55	1
AUTO TARE (1-5)	56	1
LINK PLU	57	4
PRICE	61	7
STOCK	68	6
MIX & MATCH	74	2
COST	76	7
CR/LF	83	2
TOTAL REC LENGTH	84	

Structure Of Polling Files

When you poll, the session will always create a poll file with the date as the name of the file. For example, if you poll on 09-23-1996, for store **BIGBOYS**, the session will create a file on the hard disk named `\SAM52M\STORES\BIGBOYS\POLL\09231996.POL`. If you poll this store a second time on the same day, it will append the data to the end of the existing file.

The structure of the poll file is as follows:

- All data is **ASCII**.
- A polling session for a store is everything that is done from the moment the PC calls the store, up to the hang-up with the store.
- The first line saved to disk of any polling session is:

```
BIGBOYS/09-23-1996/20:12:39
```

- The first three characters on the line is ASCII character decimal 16, a right arrow. This designates that this is the start of the polling session. The name of the store follows, a forward slash, the date, a forward slash, and the time in hours, minutes and seconds.
- The last line of the entire session will be saved as:

```
<END SESSION>
```

- The last three characters of the line is ASCII character decimal 17, a left arrow. This designates that this is the end of the polling session.
- If you do not define any elements in your polling session, you would have a polled file that would look something like this:

```
BIGBOYS/09-23-1996/20:12:39  
<END SESSION>
```

- When you define your polling session by choosing elements in the store's session data, the polled data will be save below line 1:

```
BIGBOYS/09-23-1996/20:12:39
```

and before the last line:

```
<END SESSION>
```

- The time and date on the first line of the session is the time and date that the session started. The second line in the file is the element that was polled. The line ends with a time and date stamp. This stamp is when the ECR was actually pre-pollled. This stamp can be different than the header stamp (line 1). If the software finished pre-poll and the session ended abruptly, then next time that you poll (possibly a day later) you sill read the data sitting in the prepoll area.

- The first line saved for each element is 2 right arrow characters followed by the key lock mode, a forward slash and the report title. For example: X1/FINANCIAL
- The last line saved for every element is :

<END REPORT>

This line ends with 2 left arrow characters.

- All data for the given element will appear between the 2 lines with 2 arrows. Data lines do not start with any arrows.
- The Clerk report will use a single arrow to designate the data pertaining to the clerk. A clerk report can have up to 99 clerks, so we have to be able to distinguish from clerk from another. See the example that follows.

Let's say our session consisted of the two elements: X1/PLU and X1/Groups. Your file \SAM52M\STORES\BIGBOYS\POLL\03172003.POL should look like this:

```

BIGBOYS /03-17-2003/14:26:45
X1/PLU
PLU#          Count   Amount
PLU1   0001         1.00    1.00
PLU2   0002         1.00    1.00
PLU3   0003         1.00    1.00
PLU4   0004         1.00    1.00
PLU5   0005         1.00    1.00
PLU6   0006         0.00    0.00
PLU7   0007         0.00    0.00
....
Totals          5.00    5.00
<End Report>
X1/GROUPS
Group#        Count   Amount
GROUP 1         5.00    5.00
GROUP 2         0.00    0.00
GROUP 3         0.00    0.00
GROUP 4         0.00    0.00
GROUP 5         0.00    0.00
GROUP 6         0.00    0.00
GROUP 7         0.00    0.00
GROUP 8         0.00    0.00
GROUP 9         0.00    0.00
GROUP 10        0.00    0.00
GROUP 11        0.00    0.00
GROUP 12        0.00    0.00
GROUP 13        0.00    0.00
GROUP 14        0.00    0.00
GROUP 15        0.00    0.00
GROUP 16        0.00    0.00
GROUP 17        0.00    0.00
GROUP 18        0.00    0.00
GROUP 19        0.00    0.00

```

CHG8-IN-D	0	0.00
CHG1 SALES	3	8.20
CHG2 SALES	2	15.00
CHG3 SALES	0	0.00
CHG4 SALES	0	0.00
CHG5 SALES	0	0.00
CHG6 SALES	0	0.00
CHG7 SALES	0	0.00
CHG8 SALES	0	0.00
FOREIGN 1	0	0.00
FOREIGN 2	0	0.00
FOREIGN 3	0	0.00
FOREIGN 4	0	0.00
DRWR TTL	22	305.14
PROMO	0	0.00
WASTE	0	0.00
TIP	0	0.00
TRAIN TTL	0	0.00
BAL FORWARD	0	0.00
GUESTS	0	0.00
P/BAL	0	0.00
CHECKS PAID	0	0.00
SERVICE	0	0.00
MIX&MATCH	0	0.00
PAYMENT TTL	0	0.00
OPEN CHK TTL	0	0.00
GRAND TOTAL	0	286.15
<End Report>		

Time Report

X1/TIME	Count	Amount
Hour		
00:00 - 00:59	0	0.00
01:00 - 01:59	0	0.00
02:00 - 02:59	0	0.00
03:00 - 03:59	0	0.00
04:00 - 04:59	0	0.00
05:00 - 05:59	0	0.00
06:00 - 06:59	0	0.00
07:00 - 07:59	0	0.00
08:00 - 08:59	0	0.00
09:00 - 09:59	0	0.00
10:00 - 10:59	9	222.20
11:00 - 11:59	9	57.95
12:00 - 12:59	0	0.00
13:00 - 13:59	0	0.00
14:00 - 14:59	0	0.00
15:00 - 15:59	2	0.00
16:00 - 16:59	0	0.00
17:00 - 17:59	0	0.00
18:00 - 18:59	0	0.00
19:00 - 19:59	0	0.00
20:00 - 20:59	0	0.00
21:00 - 21:59	0	0.00
22:00 - 22:59	0	0.00
23:00 - 23:59	0	0.00
TOTALS	20	280.15
<End Report>		

PLU Report

X1/PLU		Count	Amount
PLU#			
BLT	0001	6.00	7.99
HAMBURGER	0002	4.00	4.19
PLU3	0003	2.00	3.00
PLU4	0004	3.00	6.00
PLU5	0005	1.00	10.00
PLU6	0006	0.00	0.00
PLU7	0007	3.00	0.00
LEINENKUGEL	0008	4.00	10.99
MOOSEHEAD	0009	4.00	0.99
NO MAYO	0010	0.00	0.00
MEDIUM WELL	0011	0.00	0.00
LETTUCE	0012	0.00	0.00
TOMATO	0013	0.00	0.00
PLU14	0014	0.00	0.00
PLU15	0015	0.00	0.00
PLU16	0016	0.00	0.00
PLU17	0017	1.00	0.00
PLU18	0018	3.00	5.99
PLU19	0019	0.00	0.00
PLU20	0020	0.00	0.00
PLU21	0021	0.00	0.00
PLU22	0022	0.00	0.00
PLU23	0023	0.00	0.00
PLU24	0024	0.00	0.00
PLU25	0025	0.00	0.00
PLU26	0026	2.00	6.00
PLU27	0027	0.00	0.00
LARGE PIZZA	0028	0.00	0.00
PEPPERONI	0029	0.00	0.00
MUSHROOM	0030	0.00	0.00
<End Report>			

Clerk Report (Data for One Clerk Only)

X1/CLERK		Count	Amount
Clerk#			
Clerk# 1	CLERK 1		
NET SALE		20	280.15
NONTAX		37	259.19
TAX1 SALES		0	20.96
TAX2 SALES		0	0.00
TAX3 SALES		0	0.00
TAX4 SALES		0	0.00
TAX1		0	0.00
TAX2		0	0.00
TAX3		0	0.00
TAX4		0	0.00
XMPT1 SALES		0	0.00
XMPT2 SALES		0	0.00
XMPT3 SALES		0	0.00
XMPT4 SALES		0	0.00
EATIN TTL		2	2.00
TAKEOUT TTL		0	0.00
DRTHRU TTL		0	0.00
% 1		0	0.00
% 2		0	0.00
% 3		0	0.00
% 4		0	0.00
% 5		0	0.00
CREDIT TAX1		0	0.00
CREDIT TAX2		0	0.00
CREDIT TAX3		0	0.00
CREDIT TAX4		0	0.00
FD/S CREDIT		0	0.00
RETURN		2	-6.00
ERROR CORR		0	0.00
PREVIOUS VD		1	-1.00
VOID MODE		0	0.00
CANCEL		2	10.00

GROSS SALES	0	286.15
CASH SALES	14	56.95
CHECK SALES	1	200.00
R/A 1	1	29.99
R/A 2	0	0.00
R/A 3	0	0.00
P/O 1	1	-5.00
P/O 2	0	0.00
P/O 3	0	0.00
HASH TTL	0	0.00
CASH-IN-D	15	51.95
CHECK-IN-D	2	229.99
FD/S-IN-D	0	0.00
CHG1 SALES	3	8.20
CHG2 SALES	2	15.00
CHG3 SALES	0	0.00
CHG4 SALES	0	0.00
CHG5 SALES	0	0.00
CHG6 SALES	0	0.00
CHG7 SALES	0	0.00
CHG8 SALES	0	0.00
FOREIGN 1	0	0.00
FOREIGN 2	0	0.00
FOREIGN 3	0	0.00
FOREIGN 4	0	0.00
DRWR TTL	22	305.14
PROMO	0	0.00
WASTE	0	0.00
TIP	0	0.00
TRAIN TTL	0	0.00
BAL FORWARD	0	0.00
GUESTS	0	0.00
P/BAL	0	0.00
CHECKS PAID	0	0.00
SERVICE	0	0.00
NOSALE	1	0
MIX&MATCH	0	0
PAYMENT TTL	0	0

Group Report

X1/GROUPS	Count	Amount
Group#		
GROUP 1	47.00	280.15
GROUP 2	0.00	0.00
GROUP 3	0.00	0.00
GROUP 4	0.00	0.00
GROUP 5	0.00	0.00
GROUP 6	0.00	0.00
GROUP 7	0.00	0.00
GROUP 8	0.00	0.00
GROUP 9	0.00	0.00
GROUP 10	0.00	0.00
GROUP 11	0.00	0.00
GROUP 12	0.00	0.00
GROUP 13	0.00	0.00
GROUP 14	0.00	0.00
GROUP 15	0.00	0.00
GROUP 16	0.00	0.00
GROUP 17	0.00	0.00
GROUP 18	0.00	0.00
GROUP 19	0.00	0.00
GROUP 20	0.00	0.00
Totals	47.00	280.15
<End Report>		

Troubleshooting Common Problems

Hardware

- Refer to "Cabling Diagrams" on page 74 to verify that your direct or modem connection cable is configured properly.
- Verify that the hardware key is in place. SAM52M will not start if the key is not found. In addition, SAM52M will check for the key at various times during an edit/polling session. If the key is loose, or has been removed, the program will shut down.

Note: US Robotics Sportster™ Modems are recommended for remote connections (for both PC and ECR sites).

Software

- Verify that register software and SAM52M versions are compatible. Due to changes in program structures between various register versions, incompatibility issues may arise.

Samsung ER 5200M Series

- The register port must be set for PC communication. (See Service Mode RS232C port programming.)
- A clerk must be signed on.
- Verify that the port settings at the ER-5200M are all default (9600 BAUD, NO PARITY, 8 DATA BITS, 1 STOP BIT) and that SAM52M is set the same.

SAM52M Software

- Create a new store by selecting **Create New** from the *Stores* menu. See "Creating a New Store" on page 10.
 - ⇒ Set the correct Communication Port and BAUD rate. Be sure that the BAUD rate is identical to that set in the register port.
 - ⇒ **Only enter a phone** number here if you are using a modem to poll data.
 - ⇒ If your PC is using any *Microsoft Windows™* operating systems or any software application that has a communications-port configured, (for example a modem, mouse or other device) you may have to check on these settings to make sure there is not a conflict on the same communications port.
 - ⇒ Enter information in the *Modem Initial String* field only if you have a modem that needs to be properly configured to communicate.
- Verify that store files are uploaded in SAM52M. You must Receive (Upload) information from the ECR. Refer to "Receive Programs from ECR (Upload)" on page 40.
- If problems persist, try rebooting the PC.
- If you have trouble loading a program from SAM52M to a register, be sure the register memory allocation is set large enough for each file.

Cabling Diagrams

You can configure cables yourself with the diagram provided here, or you can order the appropriate cables from CRS Parts at 1-800-333-4949.

Direct Connection

Part # 522035

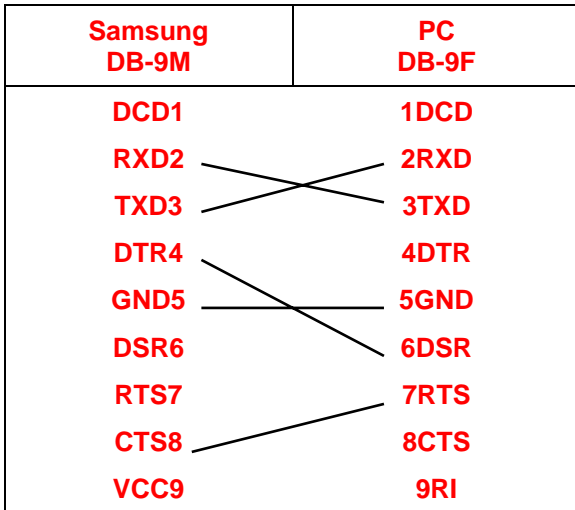

Part # 522038

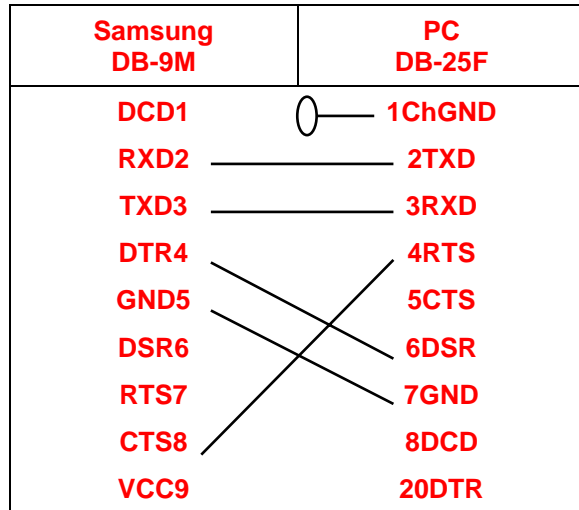

Modem Connection

Part # 522034

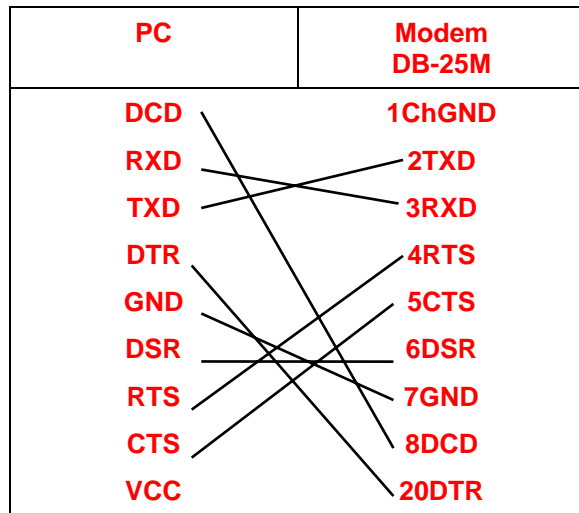
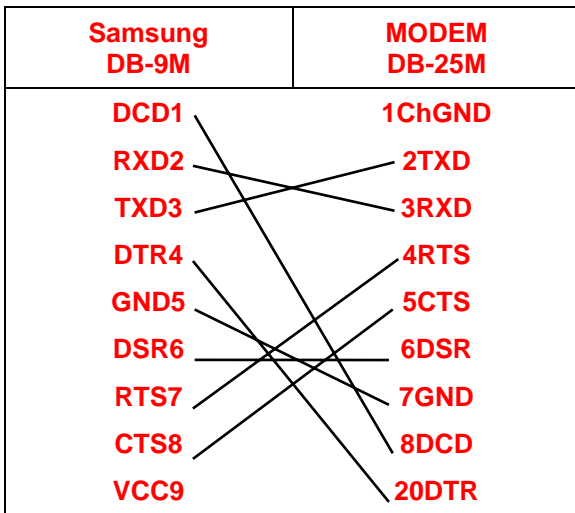

Manual Revision Record

Edition	Date published	Revision contents
V2.2	1/28/2008	
V2.3	3/17/2008	Updated to reflect software version 2.2.5